

Programmable Controller

MELSEC iQ-R
series

MELSEC iQ-R Programming Manual
(Module Dedicated Instructions)

SAFETY PRECAUTIONS

(Read these precautions before using this product.)

Before using MELSEC iQ-R series programmable controllers, please read the manuals for the product and the relevant manuals introduced in those manuals carefully, and pay full attention to safety to handle the product correctly. Make sure that the end users read this manual and then keep the manual in a safe place for future reference.

CONDITIONS OF USE FOR THE PRODUCT

(1) Mitsubishi programmable controller ("the PRODUCT") shall be used in conditions;

- i) where any problem, fault or failure occurring in the PRODUCT, if any, shall not lead to any major or serious accident; and
- ii) where the backup and fail-safe function are systematically or automatically provided outside of the PRODUCT for the case of any problem, fault or failure occurring in the PRODUCT.

(2) The PRODUCT has been designed and manufactured for the purpose of being used in general industries.

MITSUBISHI SHALL HAVE NO RESPONSIBILITY OR LIABILITY (INCLUDING, BUT NOT LIMITED TO ANY AND ALL RESPONSIBILITY OR LIABILITY BASED ON CONTRACT, WARRANTY, TORT, PRODUCT LIABILITY) FOR ANY INJURY OR DEATH TO PERSONS OR LOSS OR DAMAGE TO PROPERTY CAUSED BY the PRODUCT THAT ARE OPERATED OR USED IN APPLICATION NOT INTENDED OR EXCLUDED BY INSTRUCTIONS, PRECAUTIONS, OR WARNING CONTAINED IN MITSUBISHI'S USER, INSTRUCTION AND/OR SAFETY MANUALS, TECHNICAL BULLETINS AND GUIDELINES FOR the PRODUCT.

("Prohibited Application")

Prohibited Applications include, but not limited to, the use of the PRODUCT in;

- Nuclear Power Plants and any other power plants operated by Power companies, and/or any other cases in which the public could be affected if any problem or fault occurs in the PRODUCT.
- Railway companies or Public service purposes, and/or any other cases in which establishment of a special quality assurance system is required by the Purchaser or End User.
- Aircraft or Aerospace, Medical applications, Train equipment, transport equipment such as Elevator and Escalator, Incineration and Fuel devices, Vehicles, Manned transportation, Equipment for Recreation and Amusement, and Safety devices, handling of Nuclear or Hazardous Materials or Chemicals, Mining and Drilling, and/or other applications where there is a significant risk of injury to the public or property.

Notwithstanding the above restrictions, Mitsubishi may in its sole discretion, authorize use of the PRODUCT in one or more of the Prohibited Applications, provided that the usage of the PRODUCT is limited only for the specific applications agreed to by Mitsubishi and provided further that no special quality assurance or fail-safe, redundant or other safety features which exceed the general specifications of the PRODUCTS are required. For details, please contact the Mitsubishi representative in your region.

- For SIL2 Process CPUs

- (1) Although MELCO has obtained the certification for Product's compliance to the international safety standards IEC61508, IEC61511 from TUV Rheinland, this fact does not guarantee that Product will be free from any malfunction or failure. The user of this Product shall comply with any and all applicable safety standard, regulation or law and take appropriate safety measures for the system in which the Product is installed or used and shall take the second or third safety measures other than the Product. MELCO is not liable for damages that could have been prevented by compliance with any applicable safety standard, regulation or law.
- (2) MELCO prohibits the use of Products with or in any application involving, and MELCO shall not be liable for a default, a liability for defect warranty, a quality assurance, negligence or other tort and a product liability in these applications.
 - (a) power plants,
 - (b) trains, railway systems, airplanes, airline operations, other transportation systems,
 - (c) hospitals, medical care, dialysis and life support facilities or equipment,
 - (d) amusement equipments,
 - (e) incineration and fuel devices,
 - (f) handling of nuclear or hazardous materials or chemicals,
 - (g) mining and drilling,
 - (h) and other applications where the level of risk to human life, health or property are elevated.

- For Safety CPUs

- (1) Although MELCO has obtained the certification for Product's compliance to the international safety standards IEC61508, ISO13849-1 from TUV Rheinland, this fact does not guarantee that Product will be free from any malfunction or failure. The user of this Product shall comply with any and all applicable safety standard, regulation or law and take appropriate safety measures for the system in which the Product is installed or used and shall take the second or third safety measures other than the Product. MELCO is not liable for damages that could have been prevented by compliance with any applicable safety standard, regulation or law.
- (2) MELCO prohibits the use of Products with or in any application involving, and MELCO shall not be liable for a default, a liability for defect warranty, a quality assurance, negligence or other tort and a product liability in these applications.
 - (a) power plants,
 - (b) trains, railway systems, airplanes, airline operations, other transportation systems,
 - (c) hospitals, medical care, dialysis and life support facilities or equipment,
 - (d) amusement equipments,
 - (e) incineration and fuel devices,
 - (f) handling of nuclear or hazardous materials or chemicals,
 - (g) mining and drilling,
 - (h) and other applications where the level of risk to human life, health or property are elevated.

INTRODUCTION

Thank you for purchasing the Mitsubishi Electric MELSEC iQ-R series programmable controllers.

This manual describes the module dedicated instruction required for programming.

Before using this product, please read this manual and the relevant manuals carefully and develop familiarity with the functions and performance of the MELSEC iQ-R series programmable controller to handle the product correctly.

When applying the program examples provided in this manual to an actual system, ensure the applicability and confirm that it will not cause system control problems.

Please make sure that the end users read this manual.

CONTENTS

SAFETY PRECAUTIONS	1
CONDITIONS OF USE FOR THE PRODUCT	1
INTRODUCTION	3
RELEVANT MANUALS	8
TERMS	9
GENERIC TERMS AND ABBREVIATIONS	10
MANUAL PAGE ORGANIZATION	13

PART 1 OVERVIEW

CHAPTER 1 OVERVIEW	16
1.1 Instruction Configuration	16
1.2 Data Specification Method	18
Bit data	22
16-bit data (word data)	24
32-bit data (double word data)	27
Real number data (floating-point data)	30
String data	33
1.3 Execution Condition	35
1.4 High-speed Instruction Processing	36
Subset processing	36
1.5 Precautions on Programming	37
Errors common to instructions	37
Checking the ranges of instruction runtime devices and labels	37
Operation when a long timer or long retentive timer device is used	39
Restrictions on using file registers	41

PART 2 LISTS OF MODULE DEDICATED INSTRUCTIONS

CHAPTER 2 MODULE DEDICATED INSTRUCTIONS	44
2.1 Ethernet, CC-Link IE, and MELSECNET/H Common Instructions	44
2.2 Ethernet Instructions	46
2.3 CC-Link IE TSN Instructions	48
2.4 CC-Link IE Controller Network and MELSECNET/H Instructions	50
2.5 CC-Link IE Field Network Instructions	52
2.6 CC-Link Instructions	54
2.7 Serial Communication Instructions	55
2.8 A/D Conversion Instructions	57
2.9 Positioning Instructions	58
2.10 High Speed Data Logger Module Instructions	59
2.11 C Intelligent Function Module Instructions	60
2.12 DeviceNet Instructions	61

PART 3 MODULE DEDICATED INSTRUCTIONS

CHAPTER 3 Ethernet, CC-Link IE, AND MELSECNET/H COMMON INSTRUCTIONS

64

3.1	Link Dedicated Instructions	72
	Reading data from the programmable controller on another station	72
	Reading data from the programmable controller on another station (with notification)	81
	Writing data to the programmable controller on another station	90
	Writing data to the programmable controller on another station (with notification)	100
	Sending data to the programmable controller on another station	111
	Receiving data from the programmable controller on another station	121
	Receiving data from the programmable controller on another station (for interrupt programs)	128
	Reading data from the programmable controller (Q series-compatible)	133
	Writing data to the programmable controller (Q series-compatible)	138
	Remote RUN/STOP	143
	Reading/writing clock data	152
3.2	CC-Link Dedicated Instructions	161
	Reading data from the target station	161
	Writing data to the target station	166

CHAPTER 4 Ethernet INSTRUCTIONS

171

4.1	Open/Close Processing Instructions	171
	Opening a connection	171
	Closing a connection	175
	Opening a connection	177
	Closing a connection	181
4.2	Socket Communications Instructions	184
	Reading receive data	184
	Reading receive data (for interrupt programs)	186
	Sending data	188
4.3	Fixed Buffer Communications Instructions	190
	Reading receive data	190
	Reading receive data (for interrupt programs)	193
	Sending data	195
4.4	Reinitializing the Module	198
4.5	Executing the Protocols Registered for the Predefined Protocol Support Function	202
4.6	Clearing Error Information	207
4.7	Reading Error Information	210

CHAPTER 5 CC-Link IE TSN INSTRUCTIONS

212

5.1	Reading Data from the Remote Station (16-bit Address Specified)	212
5.2	Writing Data to the Remote Station (16-bit Address Specified)	217
5.3	Reading Data from the Remote Station (32-bit Address Specified)	222
5.4	Writing Data to the Remote Station (32-bit Address Specified)	227
5.5	Reading Data from the Remote Station (16-bit Address Specified)	232
5.6	Writing Data to the Remote Station (Target Station IP Address Specified) (16-bit Address Specified)	235
5.7	Reading Data from the Remote Station (Target Station IP Address Specified) (32-bit Address Specified)	238

5.8	Writing Data to the Remote Station (Target Station IP Address Specified) (32-bit Address Specified)	241
5.9	Setting Parameters	244
5.10	Setting Parameters	252
5.11	Own Station Number/IP Address Setting	257
5.12	Sending an SLMP Message	260

CHAPTER 6 CC-Link IE Controller Network AND MELSECNET/H COMMON INSTRUCTIONS **270**

6.1	Remote RUN	270
6.2	Remote STOP	275
6.3	Reading Clock Data from the Programmable Controller on Another Station	280
6.4	Writing Clock Data to the Programmable Controller on Another Station	285
6.5	Setting the Station Number to Own Station	291

CHAPTER 7 CC-Link IE Field Network INSTRUCTIONS **294**

7.1	Reading Data from the Intelligent Device Station/Remote Device Station (16-bit Address Specified)	294
7.2	Writing Data to the Intelligent Device Station/Remote Device Station (16-bit Address Specified)	299
7.3	Reading Data from the Intelligent Device Station/Remote Device Station (32-bit Address Specified)	304
7.4	Writing Data to the Intelligent Device Station/Remote Device Station (32-bit Address Specified)	309
7.5	Reading the Module Model Information of an Intelligent Device Station	314
7.6	Reading the Module Status Information of an Intelligent Device Station	320
7.7	Setting Parameters	326
7.8	Setting the Station Number to Own Station	332
7.9	Sending an SLMP Frame	335

CHAPTER 8 CC-Link INSTRUCTIONS **340**

8.1	Reading Data from the Target Station	340
8.2	Writing Data to the Target Station	344
8.3	Reading Data from the Buffer Memory of the Specified Intelligent Device Station	348
8.4	Writing Data to the Buffer Memory of the Specified Intelligent Device Station	351
8.5	Reading Data from the Automatic Update Buffer	354
8.6	Writing Data to the Automatic Update Buffer	356
8.7	Setting Network Parameters	358
8.8	Performing a Message Transmission to a Remote Device Station	364

CHAPTER 9 SERIAL COMMUNICATION INSTRUCTIONS **370**

9.1	Sending Data Using the On-Demand Function	370
9.2	Executing the Protocols Registered for the Predefined Protocol Support Function	374
9.3	Sending Data Using the Nonprocedural Protocol	379
9.4	Receiving Data Using the Nonprocedural Protocol	383
9.5	Sending Data Using the Bidirectional Protocol	386
9.6	Receiving Data Using the Bidirectional Protocol	389
9.7	Reading the Data Send/Receive Status	392
9.8	Receiving Data Using an Interrupt Program	394
9.9	Sending Data by Using User Frames	397
9.10	Clearing Receive Data	400
9.11	Registering/Canceling the Programmable Controller CPU Monitoring	403
9.12	Initial Setting	408
9.13	Registering User Frames	412

9.14	Reading User Frames	415
9.15	Switching the Mode	419
CHAPTER 10 A/D CONVERSION INSTRUCTIONS		422
10.1	Switching the Mode	422
10.2	Reading the User Range Setting Values	425
10.3	Restoring the User Range Setting Values	444
CHAPTER 11 POSITIONING INSTRUCTIONS		464
11.1	Restoring the Absolute Position	464
11.2	Starting the Positioning	468
11.3	Teaching	471
11.4	Backing up Module Data (Writing Data to the Flash ROM)	474
11.5	Initializing the Module	477
CHAPTER 12 HIGH SPEED DATA LOGGER MODULE INSTRUCTIONS		480
12.1	File Access Instructions	480
	Recipe write	480
	Recipe read	484
CHAPTER 13 C INTELLIGENT FUNCTION MODULE INSTRUCTIONS		487
13.1	User Function Execution Instruction	487
	User function execution	487
13.2	Data Analysis Function Execution Instruction	491
	Digital filter operation	491
	Envelope calculation	498
	FFT spectrum operation	502
13.3	Statistical Analysis Function Execution Instruction	507
	Least-squares operation	507
	Determination of unit space	512
	Mahalanobis distance calculation of signal data	518
	Multiple regression analysis	524
CHAPTER 14 DeviceNet INSTRUCTIONS		531
14.1	Master Function Receive Data Area Read	531
14.2	Master Function Transmit Data Area Write	533
14.3	Slave Function Receive Data Area Read	535
14.4	Slave Function Transmit Data Area Write	537
INDEX		540
INSTRUCTION INDEX		541
	REVISIONS	544
	WARRANTY	545
	TRADEMARKS	546

RELEVANT MANUALS

Manual name [manual number]	Description	Available form
MELSEC iQ-R Programming Manual (Module Dedicated Instructions) [SH-081976ENG] (this manual)	Dedicated instructions for the intelligent function modules	e-Manual PDF
MELSEC iQ-R Programming Manual (CPU Module Instructions, Standard Functions/Function Blocks) [SH-081266ENG]	Instructions for the CPU module and standard functions/function blocks	e-Manual PDF
MELSEC iQ-R Programming Manual (Process Control Function Blocks/Instructions) [SH-081749ENG]	Standard process function blocks, tag access function blocks, tag function blocks, and process control instruction designed for the process control	e-Manual PDF
MELSEC iQ-R Programming Manual (Program Design) [SH-081265ENG]	Program specifications (ladder, ST, FBD/LD, and SFC programs)	e-Manual PDF
GX Works3 Operating Manual [SH-081215ENG]	System configuration, parameter settings, and online operations of GX Works3	e-Manual PDF



e-Manual refers to the Mitsubishi Electric FA electronic book manuals that can be browsed using a dedicated tool.

e-Manual has the following features:

- Required information can be cross-searched in multiple manuals.
- Other manuals can be accessed from the links in the manual.
- The hardware specifications of each part can be found from the product figures.
- Pages that users often browse can be bookmarked.
- Sample programs can be copied to an engineering tool.

TERMS

Unless otherwise specified, this manual uses the following terms.

Term	Description
Buffer memory	Memory in an intelligent function module for storing data such as setting values and monitored values. Buffer memory in a CPU module stores setting values and monitored values of the Ethernet function and data used for data communications among the CPU modules in a multiple CPU system.
Control CPU	A CPU module that controls connected I/O modules and intelligent function modules. In a multiple CPU system, there are multiple CPU modules and each connected module can be controlled by a different CPU module.
Control system	A system that takes control and performs network communications in a redundant system
Engineering tool	A tool used for setting up programmable controllers, programming, debugging, and maintenance
Intelligent device station	A station that exchanges I/O signals (bit data) and I/O data (word data) with the master station by cyclic transmission. This station responds to a transient transmission request from another station and also issues a transient transmission request to another station.
Intelligent function module	A module that has functions other than input and output, such as an A/D converter module and D/A converter module
Label	A label that represents a device in a given character string
Link dedicated instruction	A dedicated instruction used for transient transmission with a programmable controller of another station. Data can be communicated in the same network or with a programmable controller of another station by using this instruction.
Local station	A station that performs cyclic transmission and transient transmission with the master station and other local stations.
Master station	A station that controls the entire network. This station can perform cyclic transmission and transient transmission with all stations. Only one master station can be used in a network.
Module label	A label that represents one of memory areas (I/O signals and buffer memory areas) specific to each module in a given character string. For the module used, GX Works3 automatically generates this label, which can be used as a global label.
Operand	Devices, such as source data (s), destination data (d), number of devices (n), and others, used as parts to configure instructions and functions
Predefined protocol support function	A function of GX Works3. This function sets protocols appropriate to each external device and reads/writes protocol setting data.
Process CPU (process mode)	A Process CPU operating in process mode. Process control function blocks and the online module change function can be used.
Process CPU (redundant mode)	A Process CPU operating in redundant mode. A redundant system is configured with this CPU module. Process control function blocks and the online module change function can be executed even in this mode.
Redundant system	A system consisting of two systems that have same configuration (CPU module, power supply module, network module, and other modules). Even after an error occurs in one of the two system, the other system takes over the control of the entire system.
Remote device station	A station that exchanges I/O signals (bit data) and I/O data (word data) with the master station by cyclic transmission. This station responds to a transient transmission request from another station.
Remote I/O station	A station that exchanges I/O signals (bit data) with the master station by cyclic transmission
Request message	A processing request message sent from external devices to SLMP-compatible devices
Response message	A processing result message sent from SLMP-compatible devices in response to the request message
RnENCPU (network part)	The right side (network part) of the RnENCPU (MELSEC iQ-R Ethernet/CC-Link IE User's Manual (Startup))
SIL2 function module	Another term for the R6PSFM. This module is used with a SIL2 Process CPU as a pair and performs safety control. The module can only be paired with the SIL2 Process CPU.
SLMP	SeamLess Message Protocol. This protocol is used to access an SLMP-compatible device or a programmable controller connected to an SLMP-compatible device from an external device.
SLMP-compatible device	A device of the Mitsubishi Electric product that can transfer SLMP messages. (CC-Link IE Field Network Ethernet adapter module and Ethernet-equipped module)
Standby master station	A station that serves as a master station to continue communications if an error occurs in the master station.
Standby system	A backup system in a redundant system
Submaster station	A station that serves as a master station to control the entire network if the master station is disconnected. Only one submaster station can be used in a network.
System A	A system that is set as system A. Redundant system consists of system A and system B. The name of system A is used to distinguish these connected two systems.

Term	Description
System B	A system that is set as system B. Redundant system consists of system A and system B. The name of system B is used to distinguish these connected two systems.
System switching	A function which switches the systems between the control system and the standby system to continue operation of the redundant system when a failure or an error occurs in the control system

GENERIC TERMS AND ABBREVIATIONS

Unless otherwise specified, this manual uses the following generic terms and abbreviations.

Generic term/abbreviation	Description
A/D converter module	A generic term for MELSEC iQ-R series analog-digital converter module, channel isolated analog-digital converter module, and high speed analog-digital converter module
Analog module	A generic term for the A/D converter module, D/A converter module, and temperature input module
CC-Link IE Controller Network module	An abbreviation for the MELSEC iQ-R series CC-Link IE Controller Network-equipped module
CC-Link IE Controller Network-equipped module	A generic term for the following modules when the CC-Link IE Controller Network function is used: <ul style="list-style-type: none"> • RJ71GP21-SX • RJ71GP21S-SX • RJ71EN71 • RnENCPU
CC-Link IE Field Network master/local module	An abbreviation for the CC-Link IE Field Network-equipped master/local module
CC-Link IE Field Network-equipped master/local module	A generic term for the following modules when the CC-Link IE Field Network function is used: <ul style="list-style-type: none"> • RJ71GF11-T2 • RJ71EN71 • RnENCPU
CPU module	An abbreviation for the MELSEC iQ-R series CPU module
D/A converter module	A generic term for the MELSEC iQ-R series digital-analog converter module, channel isolated digital-analog converter module, and high speed digital-analog converter module
Ethernet interface module with built-in CC-Link IE	A generic term for the following modules when the Ethernet function is used: <ul style="list-style-type: none"> • RJ71EN71 • CPU module
Ethernet module	An abbreviation for the MELSEC iQ-R series CC-Link IE built-in Ethernet interface module
External device	A generic term for the personal computer and other Ethernet-equipped modules connected over Ethernet for data communications
External device	A generic term for devices that send SLMP request messages to a SLMP-compatible device (personal computers, HMI (Human Machine Interface) and others)
FBD/LD	An abbreviation for the function block diagram/ladder diagram
I/O module	A generic term for the input module, output module, I/O combined module, and interrupt module
MELSECNET/10	An abbreviation for the MELSECNET/10 network system
MELSECNET/H	An abbreviation for the MELSECNET/H network system
Network module	A generic term for the following modules: <ul style="list-style-type: none"> • Ethernet interface module • CC-Link IE TSN master/local module • CC-Link IE Controller Network module • CC-Link IE Field Network module • MELSECNET/H network module • MELSECNET/10 network module • RnENCPU (network part)
Positioning module	An abbreviation for the MELSEC iQ-R series positioning module
Process CPU	A generic term for the R08PCPU, R16PCPU, R32PCPU, and R120PCPU
Programmable controller CPU	A generic term for the R00CPU, R01CPU, R02CPU, R04CPU, R04ENCPU, R08CPU, R08ENCPU, R16CPU, R16ENCPU, R32CPU, R32ENCPU, R120CPU, and R120ENCPU
Remote head module	An abbreviation for the RJ72GF15-T2 CC-Link IE Field Network remote head module
RnCPU	A generic term for the R00CPU, R01CPU, R02CPU, R04CPU, R08CPU, R16CPU, R32CPU, and R120CPU
RnENCPU	A generic term for the R04ENCPU, R08ENCPU, R16ENCPU, R32ENCPU, and R120ENCPU
RnPCPU	A generic term for the R08PCPU, R16PCPU, R32PCPU, and R120PCPU
Safety CPU	A generic term for the R08SFCPU, R16SFCPU, R32SFCPU, and R120SFCPU. This module is used with a safety function module as a pair and performs both standard and safety control.
SFC	An abbreviation for the sequential function chart

Generic term/abbreviation	Description
SIL2 Process CPU	A generic term for the R08PSFCPU, R16PSFCPU, R32PSFCPU, and R120PSFCPU. This module is used with an SIL2 function module as a pair, and performs both standard control and safety control. Use the SIL2 Process CPU with the redundant function module as a pair to configure a redundant system.
ST language	An abbreviation for the structured text language
Temperature input module	A generic term for the MELSEC iQ-R series channel isolated thermocouple input module and channel isolated RTD input module

Instruction symbols

Unless otherwise specified, this manual uses the following generic symbols for some instructions.

Classification	Instruction symbol	Generic symbol
Ethernet, CC-Link IE, and MELSECNET/H common instruction	JP.READ, GP.READ	READ
	JP.SREAD, GP.SREAD	SREAD
	JP.WRITE, GP.WRITE	WRITE
	JP.SWRITE, GP.SWRITE	SWRITE
	JP.SEND, GP.SEND	SEND
	JP.RECV, GP.RECV	RECV
	G.RECVS, Z.RECVS	RECVS
	J(P).REQ, G(P).REQ	REQ
	J(P).RIRD, G(P).RIRD	RIRD
	J(P).RIWT, G(P).RIWT	RIWT
Ethernet instruction	GP.OPEN, ZP.OPEN	OPEN
	GP.CLOSE, ZP.CLOSE	CLOSE
	GP.BUFRCV, ZP.BUFRCV	BUFRCV
	G.BUFRCVS, Z.BUFRCVS	BUFRCVS
	GP.BUFSND, ZP.BUFSND	BUFSND
	G(P).UINI, Z(P).UINI	UINI
CC-Link IE TSN Instruction	JP.REMFR, ZP.REMFR	REMFR
	JP.REMTO, ZP.REMTO	REMTO
	JP.REMFRD	REMFRD
	JP.REMTOD	REMTOD
	GP.REMFRIP	REMFRIP
	GP.REMFRDIP	REMFRDIP
	GP.REMTOIP	REMTOIP
	GP.REMTODIP	REMTODIP
	G(P).CCPASETX	CCPASETX
	G(P).CCPASET	CCPASET
	G(P).UINI, Z(P).UINI	UINI
	J(P).SLMPSND, G(P).SLMPSND	SLMPSND
CC-Link IE Controller Network and MELSECNET/H common instruction	J(P).RRUN, G(P).RRUN, Z(P).RRUN	RRUN
	J(P).RSTOP, G(P).RSTOP, Z(P).RSTOP	RSTOP
	J(P).RTMRD, G(P).RTMRD, Z(P).RTMRD	RTMRD
	J(P).RTMWR, G(P).RTMWR, Z(P).RTMWR	RTMWR
	G(P).UINI, Z(P).UINI	UINI
CC-Link IE Field Network instruction	JP.REMFR, ZP.REMFR	REMFR
	JP.REMTO, ZP.REMTO	REMTO
	JP.REMFRD	REMFRD
	JP.REMTOD	REMTOD
	J(P).SINFYRD, G(P).SINFYRD	SINFYRD
	J(P).SINFSTRD, G(P).SINFSTRD	SINFSTRD
	G(P).CCPASET	CCPASET
	G(P).UINI, Z(P).UINI	UINI
	J(P).SLMPREQ, G(P).SLMPREQ	SLMPREQ
Positioning instruction	G.ABRST1, G.ABRST2, G.ABRST3, G.ABRST4, Z.ABRST1, Z.ABRST2, Z.ABRST3, Z.ABRST4	ABRST□
	GP.PSTR1, GP.PSTR2, GP.PSTR3, GP.PSTR4, ZP.PSTR1, ZP.PSTR2, ZP.PSTR3, ZP.PSTR4	PSTR□
	GP.TEACH1, GP.TEACH2, GP.TEACH3, GP.TEACH4, ZP.TEACH1, ZP.TEACH2, ZP.TEACH3, ZP.TEACH4	TEACH□
	GP.PFWRT, ZP.PFWRT	PFWRT
	GP.PINIT, ZP.PINIT	PINIT

MANUAL PAGE ORGANIZATION

In this manual, pages are organized and the symbols are used as shown below.

How to read Part 3

The following illustration is for explanation purpose only, and should not be referred to as an actual documentation.

Adding a record to the data base

1 → **DBINSERT(P)**

2 → **RnCPU (nENCPU)** **RnCPU (Process)** **RnCPU (Normal)** **RnCPU (Standard)** **RnCPU (Safety)**

These instructions add a record to the table of the database corresponding to the specified identification number.

3 → **Ladder** **ST**

ENO=DBINSERT(EN,s1,s2,s3,s4,d1,d2);
END=DBINSERTP(EN,s1,s2,s3,s4,d1,d2);

FBD/LD

EN ENO
s1 d1
s2 d2
s3
s4

4 → **Execution condition**

Instruction	Execution condition
DBINSERT	
DBINSERTP	

5 → **Setting data**

Descriptions, ranges, and data types

Operand	Description	Range	Data type	Data type (label)
(s1)	Database identification number	1 to 4	16-bit signed binary	ANY16
(s2)	Start device for storing the database table names.	—	Unicode string	ANYSTRING_DDOUBLE
(s3)	Start device for storing the database field names.	—	Word	ANY16 ¹
(s4)	Start device for storing insertion data	—	Word	ANY16 ¹
	Completion device (start device that is turned on upon completion of instruction)	—	Bit	ANY16 ¹

6 → **Applicable devices**

Operand	BIT	Word	Double word	Indirect specification	Constant	Others
	X, Y, M, L, SM, F, B, SB, FX, FY	T, ST, C, D, W, SD, SW, FD, R, ZR, RD	U□□□□, J□□□□, U3□□(H)□□□	Z, LT, LST, LC, LZ	K, H, E, \$	
(s1)	—	○	—	—	—	—
(s2)	—	○	—	—	—	—
(s3)	—	○	—	—	—	—
(s4)	—	○	—	—	—	—

7 → **Control data**

Operand: (s3)

Device	Item	Description	Setting range	Set by
+0	Number of fields	Specify the number of fields to which a value is to be added. Specify a value equal to or less than the number of fields of the table specified in (s2).	1 to 16	User
+1 to +□	Field name	Specify the name of each field. Specify field names, each fixed to 32 characters, by the number of fields to be added. Specify character strings, for the name less than 32 characters, right-justified and filled with 0000H to	—	User

8 → **Processing details**

- These instructions add a record to the table specified by (s2) in the database corresponding to the identification number specified by (s1).
- Specify the number of fields of the record to be added, field names, and data types in (s3). For the field names to be added, not all fields making up the table need to be specified. Store NULL in the fields which are not specified.
- Specify the number of records to be added and the size and value per record in (s4). One to sixteen records can be set.

9 → **Precautions**

In the following cases, the error completion signal in (d1)+1 is turned on and an error code is stored as the completion status in the device (d2).

- The DBINSERT(P) instruction is executed during execution of the database access instruction.
- An identification number outside the range is specified by (s1).
- An identification number of a database which is not open is specified by (s1).
- The table name specified by (s2) does not exist.
- The number of characters of the table name specified by (s2) exceeds 32.
- An out-of-range value is specified in (s3) for the number of fields to be added.
- An out-of-range value is specified in (s4) for the number of records to be added.
- Database insertion processing failed.
- The range of the data for one record set in (s4)+2 does not match the size specified by (s4)+1.

10 → **Operation error**

Error code (SD0)	Description
2820H	The area specified by (s) or (d) exceeds the applicable range of the device/table used.

1 Instruction symbol

- An instruction symbol followed by parentheses indicates multiple instructions. For example, "J(P).REQ" indicates two instructions: J.REQ and JP.REQ.

Instruction symbol	Meaning
Instruction symbol followed by "(P)"	This instruction is executed only on the rising edge (off to on).
Instruction symbol followed by "(_U)"	This instruction handles 16-bit or 32-bit unsigned binary data.

- An instruction symbol followed by "□" indicates multiple instructions. For example, "G.ABRST□" indicates four instructions: G.ABRST1, G.ABRST2, G.ABRST3, and G.ABRST4.

2 Availability by the CPU module type (The instruction cannot be used by the CPU module marked ×.)

3 Description formats of ladder diagram, structured text language, and FBD/LD

An instruction symbol should be described in the enclosed area of each ladder or FBD/LD program.

Execution condition is input to EN of each structured text or FBD/LD program. And, execution result should be described for ENO.

4 Execution condition (☞ Page 35 Execution Condition)

5 Description of operands, setting ranges, data types, and label data types

- For the data type, refer to the following.

☞ Page 18 Data Specification Method

6 Devices that can be used as operands

Operand	Bit		Word			Double word		Indirect specification	Constant			Others ^{*5}
	X, Y, M, L, SM, F, B, SB, FX, FY	J□\□ ^{*4}	T, ST, C, D, W, SD, SW, FD, R, ZR, RD	U□\G□, J□\□ ^{*4} , U3E□\□(H)G□	Z	LT, LST, LC	LZ		K, H	E	\$	
Applicable device ^{*1}	X, Y, M, L, SM, F, B, SB, FX ^{*2} , FY ^{*2}	J□\X J□\Y J□\B J□\SB	T ^{*3} , ST ^{*3} , C ^{*3} , D, W, SD, SW, FD ^{*2} , R, ZR, RD	U□\G□ U3E□\G□ U3E□\HG□ J□\W J□\SW	Z	LT ^{*3} LST ^{*3} LC ^{*3}	LZ	@□ @□.□	K, H	E	\$	P, I, J, U, DX, DY, N, V

*1 For details on each device, refer to the following.

☞ MELSEC iQ-R CPU Module User's Manual (Application)

*2 FX and FY can be used for bit data only, and FD for word data only.

*3 When T, ST, C, LT, LST, or LC is used for instructions, it can only be used as word data. It cannot be used as bit data.

*4 This device can be used with a network module with a network number specified.

*5 In the "Others" column, a device(s) that can be set for each instruction is shown.

7 Control data. Some instructions require control data that determine the operations of the instructions. When control data need to be set by a user, set values according the setting range.

8 Processing details of the instruction. Unless otherwise specified, the following programs are regarded as interrupt programs.

- Interrupt program using the interrupt pointer (I)
- Fixed scan execution type program
- Event execution type program that is triggered by the interrupt pointer (I)

9 Precautions

10 Error code and error details if the instruction has any possible operation error

- A device in which an error code is stored is provided in the error code column. When an error code is stored in SD0, an error flag (SM0) turns on. (The error status can be checked with the module label of the CPU module.)
- For the errors not provided here, refer to the following.

☞ MELSEC iQ-R CPU Module User's Manual (Application)

PART 1

OVERVIEW

This part consists of the following chapter.

1 OVERVIEW

1 OVERVIEW

1.1 Instruction Configuration

Many instructions available for programmable controllers are each divided into the instruction part and operand part. The instruction part and operand part are used as follows.

- Instruction part: Indicates the function of the relevant instruction.
- Operand part: Indicates the data used for the instruction.

The operand part is further classified to source data, destination data, and numerical data.

Source (s)

Source is the data used in the operation.

Depending on the label or device specified in each instruction, the source becomes as follows.

Type	Description
Constant	The constant specifies a numerical value used in the operation. It is set during program creation and cannot be changed during program execution. When using constants in variable data, perform index modification.*1
Device Label	The user specifies the device or label where the data to be used in the operation is stored. Necessary data must be thus stored in the specified device or label before operation execution. By changing the data to be stored in the specified device or label during program execution, the data to be used by the instruction can be changed.

*1 For the index modification, refer to the following.

 MELSEC iQ-R CPU Module User's Manual (Application)

Destination (d)

Data after operation is stored in the destination area.

However, some instructions require the data to be used in the operation to be stored before the operation.

Ex.

Binary 16-bit data addition instruction

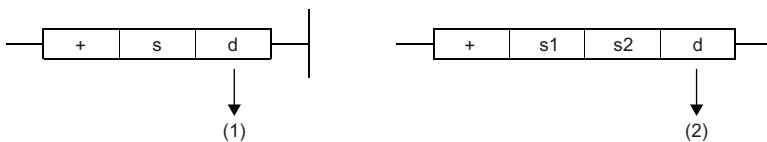

(1) The data required for operation is stored before the operation.

(2) Only the operation result is stored.

A label or device to store data must be set for the destination.

Numerical value (n)

For the numerical values of the numbers of devices, transfers, data, and character strings, specify those used by an instruction which uses multiple devices or an instruction which specifies the numbers of repetitions, data to be processed, and character strings.

Ex.

Block transfer instruction

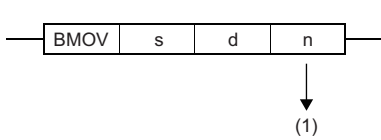

(1) The number of transfers executed by the BMOV instruction is specified.

A numerical value from 0 to 65535 or 0 to 4294967295 can be set for the size such as the number of devices, transfers, or characters.*¹

Note, however, that when the size specification such as the number of devices, transfers, or characters is 0, the relevant instruction results in non-processing.

*¹ The setting range varies depending on the instruction. For details, refer to the description of each instruction.

Point 

Be careful when a large numerical value is used such as for the number of transfers. It delays the scan time.

1.2 Data Specification Method

The following table lists the types of data that can be used for instructions in CPU modules.

Data	Classification
Bit data	Bit data
16-bit data (word data)	16-bit signed binary data
	16-bit unsigned binary data
32-bit data (double word data)	32-bit signed binary data
	32-bit unsigned binary data
Real number data (floating-point data)	Single-precision real number data
	Double-precision real number data
BCD data	BCD 4-digit data
	BCD 8-digit data
	BCD 16-digit data
String data	String
	Unicode string

Device data

The following table lists devices and constants that can be used to specify the setting data of instructions.

Data type	Description	Specifiable device/constant* ¹
Bit	Bit data can be handled. ☞ Page 22 Bit data	<ul style="list-style-type: none"> • Bit device • Bit specification of word device
Word	Word data can be handled. ☞ Page 24 16-bit data (word data)	<ul style="list-style-type: none"> • Word device • Digit-specified bit device (K1 to K4)^{*2}
16-bit signed binary	16-bit data can be handled.	<ul style="list-style-type: none"> • Decimal constant • Hexadecimal constant
16-bit unsigned binary	The value range varies depending on whether the value is signed or unsigned. ☞ Page 24 16-bit data (word data)	
Double word	Double-word data can be handled. ☞ Page 27 32-bit data (double word data)	<ul style="list-style-type: none"> • Word device • Double-word device
32-bit signed binary	Two consecutive sets of 32-bit data or 16-bit data can be handled.	<ul style="list-style-type: none"> • Digit-specified bit device (K1 to K8)^{*2} • Decimal constant • Hexadecimal constant
32-bit unsigned binary	The value range varies depending on whether the value is signed or unsigned. ☞ Page 27 32-bit data (double word data)	
BCD 4-digit	BCD 4-digit data can be handled. 16-bit data is divided by 4 digits and each digit is specified in 0 to 9.	<ul style="list-style-type: none"> • Word device • Digit-specified bit device (K1 to K4)^{*2} • Decimal constant • Hexadecimal constant
BCD 8-digit	BCD 8-digit data can be handled. 32-bit data is divided by 8 digits and each digit is specified in 0 to 9.	<ul style="list-style-type: none"> • Word device • Double-word device • Digit-specified bit device (K1 to K8)^{*2} • Decimal constant • Hexadecimal constant
Single-precision real number	Single-precision real number data (single-precision floating-point data) can be handled. ☞ Page 30 Configuration of single-precision real number data	<ul style="list-style-type: none"> • Word device • Double-word device • Real constant
Double-precision real number	Double-precision real number data (double-precision floating-point data) can be handled. ☞ Page 31 Configuration of double-precision real number data	<ul style="list-style-type: none"> • Word device • Double-word device • Real constant
Character string	ASCII code and Shift JIS code character string data can be handled. ☞ Page 33 String data	<ul style="list-style-type: none"> • Word device • Character string constant
Unicode character string	Unicode character string data can be handled. ☞ Page 33 String data	<ul style="list-style-type: none"> • Word device • Character string constant
Device name	A device can be specified directly.	<ul style="list-style-type: none"> • Device name corresponding to applicable device

*1 A constant can be used in the data specified for the source (s) or numerical data (n) by an instruction.

*2 For the specification method, refer to the detail page of each data type.

Label data

The following table lists labels that can be used to specify the setting data of instructions.

■ Primitive data type

Data type (label)	Specifiable label
Bit (BOOL)	<ul style="list-style-type: none">• Bit type label• Bit-specified word [unsigned]/bit string [16 bits] type label• Bit-specified word [signed] type label• Timer/retentive timer/long timer/long retentive timer type label contact/coil• Counter/ long counter type label contact/coil
Word [unsigned]/bit string [16 bits] (WORD)	<ul style="list-style-type: none">• Word [unsigned]/bit string [16 bits] type label• Digit-specified bit type label (K1 to K4)• Current value of timer/retentive timer type label• Current value of counter type label
Double word [unsigned]/bit string [32 bits] (DWORD)	<ul style="list-style-type: none">• Double word [unsigned]/bit string [32 bits] type label• Digit-specified bit type label (K1 to K8)• Current value of long timer/long retentive timer type label• Current value of long counter type label
Word [signed] (INT)	<ul style="list-style-type: none">• Word [signed] type label• Digit-specified bit type label (K1 to K4)• Current value of timer/retentive timer type label• Current value of counter type label
Double word [signed] (DINT)	<ul style="list-style-type: none">• Double word [signed] type label• Digit-specified bit type label (K1 to K8)• Current value of long timer/long retentive timer type label• Current value of long counter type label
Single-precision real number (REAL)	<ul style="list-style-type: none">• Single-precision real data type label
Double-precision real number (LREAL)	<ul style="list-style-type: none">• Double-precision real data type label
Time (TIME)	<ul style="list-style-type: none">• Time type label
Character string (STRING)	<ul style="list-style-type: none">• Character string type label
Character string [Unicode] (WSTRING)	<ul style="list-style-type: none">• Character string [Unicode] type label
Pointer (POINTER)	<ul style="list-style-type: none">• Pointer type label



For details on individual labels, refer to the following.

MELSEC iQ-R CPU Module User's Manual (Application)

■ Generic data type

The generic data type is the data type of the labels which summarize several primitive data types.

Generic data types are used when multiple data types are allowed for arguments and return values of functions or function blocks.

Labels defined in generic data types can be used in any sub-level data type.

Data type (label)					Specifiable data type	
ANY* ¹	ANY_ELEMENTARY	ANY_BIT			ANY_BOOL	Bit
					ANY_BITADDR* ¹	Bit
					ANY16_U	Word [unsigned]/bit string [16 bits]
					ANY32_U	Double word [unsigned]/bit string [32 bits]
	ANY_WORDADDR	ANY_NUM	ANY_INT	ANY16	ANY16_S	Word [signed]
				ANY16_U	Word [unsigned]/bit string [16 bits]	
			ANY_REAL	ANY32	ANY32_S	Double word [signed], time
				ANY32_U	Double word [unsigned]/bit string [32 bits]	
		ANY_STRING			ANYSTRING_SINGLE	String
		ANY16_OR_STRING_SINGLE			ANYSTRING_DOUBLE	Character string [Unicode]
					ANY16_S	Word [signed]
					ANY16_U	Word [unsigned]/bit string [16 bits]
		ANY_DT			ANYSTRING_SINGLE	String
		ANY_TM			ANY16_S	Word [signed], word [unsigned]/bit string [16 bits]
	ANY_DT			ANY16_U	Word [unsigned]/bit string [16 bits]	
	ANY_TM			ANYSTRING_SINGLE	String	
	ANY_STRUCT* ¹					Word [signed], word [unsigned]/bit string [16 bits]
STRUCT					Word [signed], word [unsigned]/bit string [16 bits]	
ANY_STRUCT* ¹					Structures	
STRUCT					Structures	

*1 Can also be used as an array.

■ Generic data type (array)

For the following generic data type, define the number of array elements.

Data type (label)			Specifiable data type
ANYBIT_ARRAY			Bit array
ANYWORD_ARRAY	ANY16_ARRAY	ANY16_S_ARRAY	Word [signed] array
		ANY16_U_ARRAY	Word [unsigned]/bit string [16 bits] array
	ANY32_ARRAY	ANY32_S_ARRAY	Double word [signed] array, time array
		ANY32_U_ARRAY	Double word [unsigned]/bit string [32 bits] array
	ANY_REAL_ARRAY	ANY_REAL_32_ARRAY	Single-precision real number array
		ANY_REAL_64_ARRAY	Double-precision real number array
	ANY_STRING_ARRAY	ANY_STRING_SINGLE_ARRAY	String data array
		ANY_STRING_DOUBLE_ARRAY	Character string [Unicode] array
STRUCT_ARRAY			Structure array

Bit data

Data size and data range

Bit data is handled in increments of bits such as contacts and coils.

Data name	Data size	Value range
Bit data	1 bit	0, 1

Handling bit data with bit devices/labels

One point of bit device/label can handle 1-bit data.

Handling bit data with bit word devices

By specifying a bit number for a word device, bit data of the specified bit number can be handled.

A bit in a word device can be specified by "Word device number.Bit number".

A bit number can be specified in hexadecimal in the range from 0 to F.

For example, bit 5 (b5) of D0 is specified as D0.5, and bit 10 (b10) of D0 is specified as D0.A.

The following word devices support bit specification.

Item	Device
Word devices which support bit specification	<ul style="list-style-type: none">• Data register (D)• Link register (W, J□\W)• Link special register (SW, J□\SW)• Function register (FD)• Special register (SD)• Module access device (U□\G)• CPU buffer memory access device (U3E□\G, U3E□\HG)• File register (R, ZR)• Module refresh register (RD)

Handling bit data with word type labels

By specifying a bit number for a word type label, bit data of the specified bit number can be handled.

A bit in a word type label can be specified by "Label name.Bit number".

Ex.

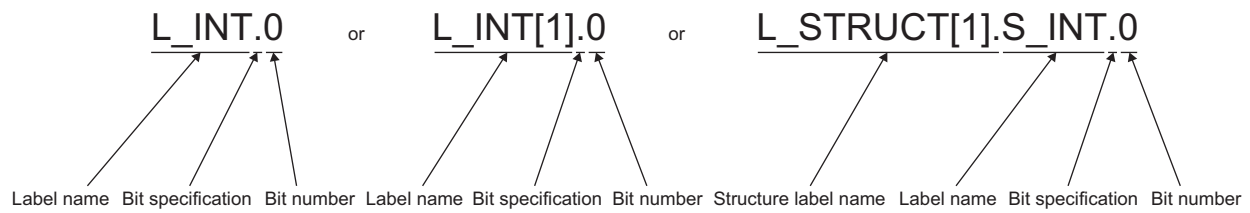

The following data types of labels support bit specification.

Item	Data type
Data types of labels which support bit specification.	<ul style="list-style-type: none"> • Word [signed] (INT type) • Word [unsigned]/bit string [16 bits] (WORD type) • Current value (N) of timer (TIMER type)^{*1} • Current value (N) of retentive timer (RETENTIVETIMER type)^{*1} • Current value (N) of counter (COUNTER type)^{*1}

*1 Cannot be specified in ladder programs.

16-bit data (word data)

Data size and data range

16-bit data includes signed and unsigned 16-bit data.

In signed 16-bit data, a negative number is represented in two's complement.

Data name	Data size	Value range	
		Decimal notation	Hexadecimal notation
Signed 16-bit data	16 bits (1 word)	-32768 to 32767	0000H to FFFFH
Unsigned 16-bit data		0 to 65535	

Handling 16-bit data with bit devices

A bit device can be handled as 16-bit data by performing digit specification.

Item		Notation	Example
Bit device	Other than link direct device	K□Bit device start number □: Number of digits (Specify the number within the range of 1 to 4.)	K4X10 K2M113
	Link direct device	J□\K□Bit device start number □ (on the left): Network number □ (on the right): Number of digits (Specify the number within the range of 1 to 4.)	J1\K3B10 J10\K2Y10

Handling 16-bit data with bit type array labels

A bit type array label can be handled as 16-bit data by performing digit specification.

The following table shows the notation for handling a bit type array label as 16-bit data by digit specification.

Item	Notation	Example
Bit type array label	K□Label name □: Number of digits (Specify the number within the range of 1 to 4.) Specify a label name without an array element.	K1L_BOOL

Digit specification range

The following table lists the range of 16-bit data for each digit specification.

Digit specification	Decimal notation	Hexadecimal notation
K1	0 to 15	0H to FH
K2	0 to 255	00H to FFH
K3	0 to 4095	000H to FFFH
K4	Signed 16-bit data: -32768 to 32767 Unsigned 16-bit data: 0 to 65535	0000H to FFFFH

Ex.

When digit specification is made for X0, the applicable number of points is as follows.

- K1X0→4 points from X0 to X3
- K2X0→8 points from X0 to X7
- K3X0→12 points from X0 to XB
- K4X0→16 points from X0 to XF

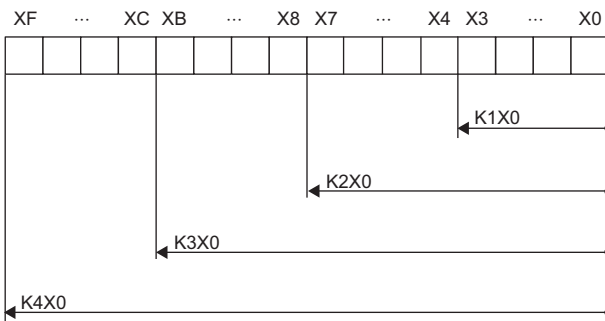

■ Specifying a bit device with digit specification in the source (s)

When a bit device with digit specification is specified in the source of an instruction, 0 is stored in the bits, which follow the bit for which digit specification is made in the source, in the word device of the destination.

Ladder example	Processing
<p>• 16-bit data instruction</p>	

■ Specifying a bit device with digit specification in the destination (d)

When a digit specification is made in the destination of an instruction, the number of points by the digit specification is applicable in the destination.

The bit devices after the number of points specified by digits remain unchanged.

Ladder example	Processing
<p>• When the source data is a word device</p>	

Handling 16-bit data with word devices/labels

■Word device

One point of word device can handle 16-bit data.

■Word type label

One point of word type label can handle 16-bit data.

32-bit data (double word data)

Data size and data range

32-bit data includes signed and unsigned 32-bit data.

In signed 32-bit data, a negative number is represented in two's complement.

Data name	Data size	Value range	
		Decimal notation	Hexadecimal notation
Signed 32-bit data	32 bits (2 word)	-2147483648 to 2147483647	00000000H to FFFFFFFFH
Unsigned 32-bit data		0 to 4294967295	

Handling 32-bit data with bit devices

A bit device can be handled as 32-bit data by performing digit specification.

Item		Notation	Example
Bit device	Other than link direct device	K□ Bit device start number ↑ Number of digits: Specify the number within the range of 1 to 8.	K8X80 K6B018
	Link direct device	J□/K□ Bit device start number ↑ ↑ Number of digits: Specify the number within the range of 1 to 8. Network number	

Handling 32-bit data with bit type array labels

A bit type array label can be handled as 32-bit data by performing digit specification.

The following table shows the notation for handling a bit type array label as 32-bit data by digit specification.

Item	Notation	Example
Bit type array label	K□ Label name ↑ Number of digits: Specify the number within the range of 1 to 8. Specify a label name without an array element. For languages other than ladder, specify the number within the range of K5 to K8. (For languages other than ladder, the label with digit specification within the range of K1 to K4 is handled as ANY16.)	K8L_BOOL

Digit specification range

The following table lists the range of 32-bit data for each digit specification.

Digit specification	Decimal notation	Hexadecimal notation
K1	0 to 15	0H to FH
K2	0 to 255	00H to FFH
K3	0 to 4095	000H to FFFH
K4	0 to 65535	0000H to FFFFH
K5	0 to 1048575	00000H to FFFFFH
K6	0 to 16777215	000000H to FFFFFFFH
K7	0 to 268435455	0000000H to FFFFFFFFH
K8	Signed 32-bit data: -2147483648 to 2147483647 Unsigned 32-bit data: 0 to 4294967295	00000000H to FFFFFFFFH

Ex.

When digit specification is made for X0, the applicable number of points is as follows.

- K1X0→4 points from X0 to X3
- K2X0→8 points from X0 to X7
- K3X0→12 points from X0 to XB
- K4X0→16 points from X0 to XF
- K5X0→20 points from X0 to X13
- K6X0→24 points from X0 to X17
- K7X0→28 points from X0 to X1B
- K8X0→32 points from X0 to X1F

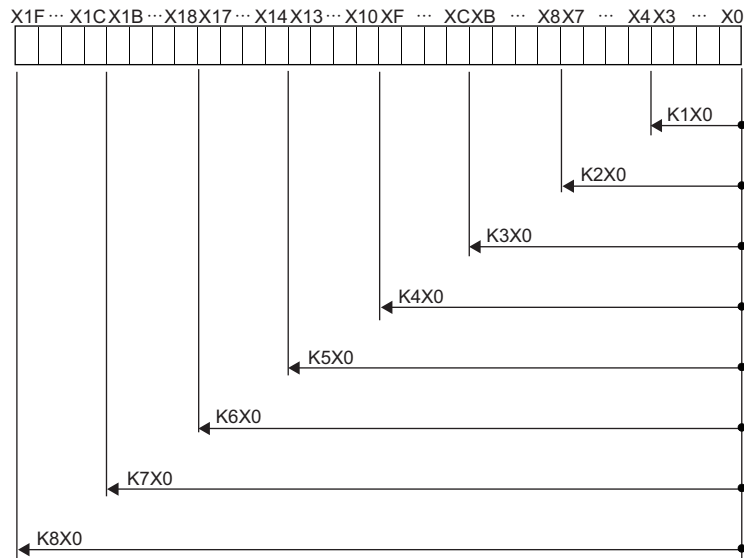

■Specifying a bit device with digit specification in the source (s)

When a bit device with digit specification is specified in the source of an instruction, 0 is stored in the bits, which follow the bit for which digit specification is made in the source, in the word device of the destination.

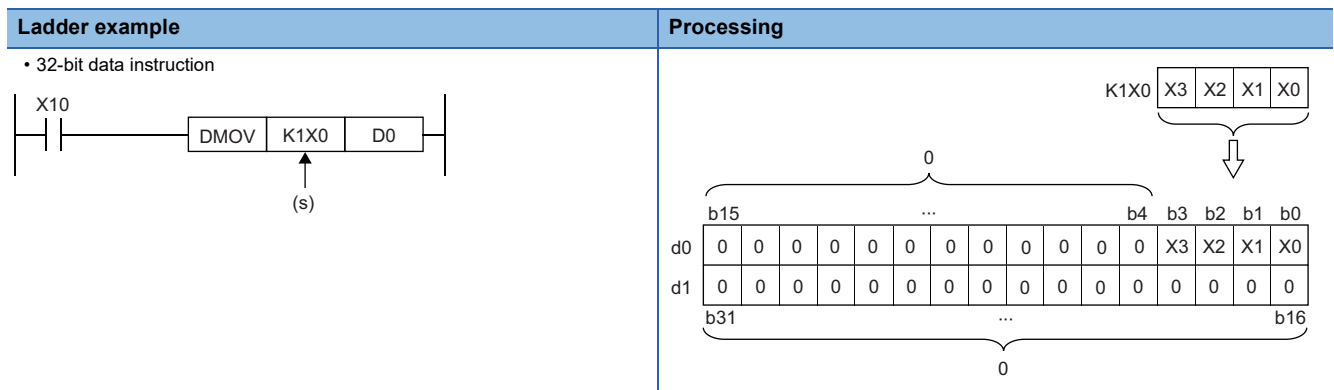

■Specifying a bit device with digit specification in the destination (d)

When a digit specification is made in the destination of an instruction, the number of points by the digit specification is applicable in the destination.

The bit devices after the number of points specified by digits remain unchanged.

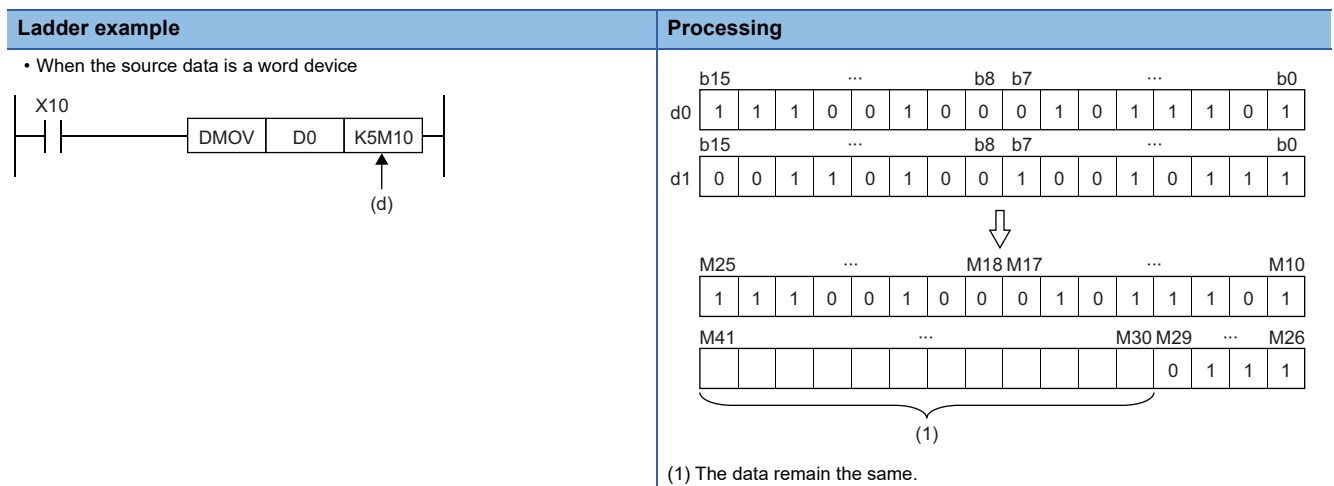

Handling 32-bit data with word devices/labels

■Word device

Two points of word device can handle 32-bit data.

Note, however, that one point of the following devices can handle 32-bit data.

- Long timer (LT)
- Long retentive timer (LST)
- Long counter (LC)
- Long index register (LZ)

■Double word type label

One point of double word device can handle 32-bit data.

Real number data (floating-point data)

Data size and data range

Real number data includes single-precision 32-bit real number data and double-precision 64-bit real number data.

Real number data can be stored only in devices other than bit devices or in single-precision or double-precision real data type labels.

Data name		Data size	Value range
Single-precision real number data (single-precision floating-point data)	Positive number	32 bits (2 word)	$2^{-126} \leq \text{real number} < 2^{128}$
	Zero		0
	Negative number		$-2^{128} < \text{real number} \leq -2^{-126}$
Double-precision real number data (double-precision floating-point data)	Positive number	64 bits (4 word)	$2^{-1022} \leq \text{real number} < 2^{1024}$
	Zero		0
	Negative number		$-2^{1024} < \text{real number} \leq -2^{-1022}$

Configuration of single-precision real number data

Single-precision real number data consists of a sign, mantissa, and exponent, and is expressed as shown below.



The following figure shows the bit configuration of the internal expression of single-precision real number data and the meaning of each part.

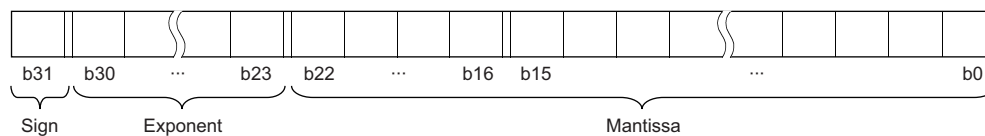

■ Sign (1 bit)

This bit represents the positive or negative sign of a numerical value. "0" indicates a positive number or 0. "1" Indicates a negative number.

■ Mantissa (23 bits)

A mantissa means XXXXX... of $1.XXXXX... \times 2^N$ representing a single-precision real number in binary.

■ Exponent (8 bits)

An exponent means N of $1.XXXXX... \times 2^N$ representing a single-precision real number in binary. The following table shows the relationships between the exponent value and N of a single-precision real number.

Exponent (b24 to b30)	FFH	FEH	FDH	...	81H	80H	7FH	7EH	...	02H	01H	00H
N	Not used	127	126	...	2	1	0	-1	...	-125	-126	Not used

Configuration of double-precision real number data

Double-precision real number data consists of a sign, mantissa, and exponent, and is expressed as shown below.



The following figure shows the bit configuration of the internal expression of double-precision real number data and the meaning of each part.

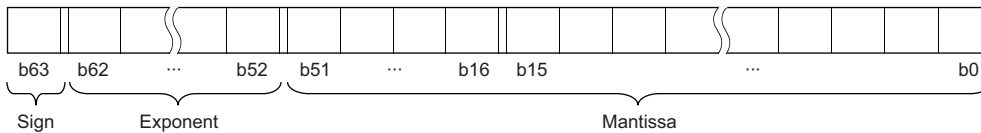

■ Sign (1 bit)

This bit represents the positive or negative sign of a numerical value. "0" indicates a positive number or 0. "1" Indicates a negative number.

■ Mantissa (52 bits)

A mantissa means XXXXX... of $1.XXXXX... \times 2^N$ representing a single-precision real number in binary.

■ Exponent (11 bits)

An exponent means N of $1.XXXXX... \times 2^N$ representing a single-precision real number in binary. The following table shows the relationships between the exponent value and N of a single-precision real number.

Exponent (b52 to b62)	7FFH	7FEH	7FDH	...	401H	400H	3FFH	3FEH	...	02H	01H	00H
N	Not used	1023	1022	...	2	1	0	-1	...	-1021	-1022	Not used

Precautions

■ When setting an input value of single-precision real number from the engineering tool

The number of significant digits is about 7 because the engineering tool processes single precision real number data in 32-bit single precision.

When the input value of single-precision real number data exceeds 7 digits, the 8th digit is rounded off.

Therefore, if the rounded-off value goes out of the range from -2147483648 to 2147483647, it will not be an intended value.

Ex.

When "2147483647" is set as an input value, it is handled as "2147484000" because 8th digit "6" is rounded off.

Ex.

When "E1.1754943562" is set as an input value, it is handled as "E1.175494" because 8th digit "3" is rounded off.

Set an input value within the following range. If the set value is out of the following range, a conversion error occurs.

Decimal point expression: $0.000000001 \leq \text{Absolute value of real number data} \leq 99999990000.0$

Exponential notation: $1.175494351E-38 \leq \text{Absolute value of real number data} \leq 3.402823466E+38$

■ When setting an input value of double-precision real number from the engineering tool

The number of significant digits is about 15 because the engineering tool processes double precision real number data in 64-bit double precision.

When the input value of double-precision real number data exceeds 15 digits, the 16th digit is rounded off.

Therefore, if the rounded-off value goes out of the range from -2147483648 to 2147483647, it will not be an intended value.

Ex.

When "2147483646.12345678" is set as an input value, it is handled as "2147483646.12346" because 16th digit "8" is rounded off.

Ex.

When "E1.7976931348623157+307" is set as an input value, it is handled as "E1.79769313486232+307" because 16th digit "5" is rounded off.

Set an input value within the following range. If the set value is out of the following range, a conversion error occurs.

Decimal point expression: $0.00000000000000000001 \leq \text{Absolute value of real number data} \leq 999999999999999900000.0$

Exponential notation: $2.22507385850721E-308 \leq \text{Absolute value of real number data} \leq 1.79769313486231E+308$

Point

The monitor function of the engineering tool can monitor real number data of CPU modules.

To represent "0" in real number data, set all numbers in each of the following range to 0.

- Single-precision real number data: b0 to b31
- Double-precision real number data: b0 to b63

The setting range of real number data is as follows.*1

- Single-precision real number data: $-2^{128} < [\text{single-precision real number data}] \leq -2^{-126}, 0, 2^{-126} \leq [\text{single-precision real number data}] < 2^{128}$
- Double-precision real number data: $-2^{1024} < [\text{double-precision real number data}] \leq -2^{-1022}, 0, 2^{-1022} \leq [\text{double-precision real number data}] < 2^{1024}$

Do not specify "-0" (only the most significant bit is 1) in real number data. Performing a real number operation using -0 results in an operation error.

*1 For the operations to be performed when an overflow or underflow occurs or when a special value is input, refer to the following.

 MELSEC iQ-R CPU Module User's Manual (Application)

String data

Format of character string data

The following table lists the types of character string data, each of which ends with a NULL code to be handled as a character string.

Type	Character code	Last character
Character string	ASCII code, Shift JIS code	NULL(00H)
Unicode character string	Unicode (UTF-16 (little endian))	NULL(0000H)

Character string data is stored in devices or an array in ascending order of device numbers or array element numbers.

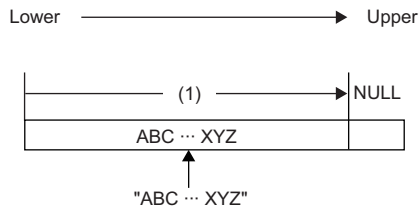

(1) Character code string

Notation of character string

The following shows the notation of character strings in ladder programs.

Data type	Notation	Example
String	STRING	Enclose a string (ASCII code, Shift JIS code) and Unicode string in double quotation marks (").
Character string [Unicode]	WSTRING	

The following shows the notation of character strings in ST programs.

Data type	Notation	Example
String	STRING	Enclose a string (ASCII code, Shift JIS code) in single quotation marks (').
Character string [Unicode]	WSTRING	Enclose a Unicode string in double quotation marks (").

The following shows the notation of character strings in FBD/LD programs.

Data type	Notation	Example
String	STRING	Enclose a string (ASCII code, Shift JIS code) in single quotation marks (').
Character string [Unicode]	WSTRING	Enclose a Unicode string in double quotation marks (").

Data range

The following table summarizes the ranges of character string data.

Type	Maximum number of characters that can be set in a label	Maximum number of characters that can be used for character string constant
Character string	255 single-byte characters (excluding the last NULL character)	16383 characters (excluding the last NULL character)
Unicode character string ^{*1}	255 characters (excluding the last NULL character)	

*1 For the Unicode character string, characters up to the basic multilingual plane can be used.

Number of words required for storing data

Character string data can be stored in word devices.

The following table lists the numbers of words required for storing character string data.

Number of character string bytes	Number of words required for storing character strings	Number of words required for storing Unicode character strings
0 byte	1 [word]	1 [word]
Odd number of bytes	$(\text{Number of character string bytes} + 1) \div 2$ [words]	— (because one character is an even number of bytes)
Even number of bytes	$(\text{Number of character string bytes} \div 2) + 1$ [words]	Number of characters + 1 [words]

Character string data storage location

An image of the character string data storage location is shown below.

■Character strings

In each character string storage image, "NULL" indicates a NULL code (00H).

Character string to be stored	Image of storing character string data from D0	Image of storing character string data from word type label array arrayA[0]												
Null character string ("") or (" ")	D0 <table border="1" style="display: inline-table;"><tr><td>NULL</td><td>NULL</td></tr></table>	NULL	NULL	arrayA[0] <table border="1" style="display: inline-table;"><tr><td>NULL</td><td>NULL</td></tr></table>	NULL	NULL								
NULL	NULL													
NULL	NULL													
ABC	D0 <table border="1" style="display: inline-table;"><tr><td>B</td><td>A</td></tr></table> D1 <table border="1" style="display: inline-table;"><tr><td>NULL</td><td>C</td></tr></table>	B	A	NULL	C	arrayA[0] <table border="1" style="display: inline-table;"><tr><td>B</td><td>A</td></tr></table> arrayA[1] <table border="1" style="display: inline-table;"><tr><td>NULL</td><td>C</td></tr></table>	B	A	NULL	C				
B	A													
NULL	C													
B	A													
NULL	C													
ABCD	D0 <table border="1" style="display: inline-table;"><tr><td>B</td><td>A</td></tr></table> D1 <table border="1" style="display: inline-table;"><tr><td>D</td><td>C</td></tr></table> D2 <table border="1" style="display: inline-table;"><tr><td>NULL</td><td>NULL</td></tr></table>	B	A	D	C	NULL	NULL	arrayA[0] <table border="1" style="display: inline-table;"><tr><td>B</td><td>A</td></tr></table> arrayA[1] <table border="1" style="display: inline-table;"><tr><td>D</td><td>C</td></tr></table> arrayA[2] <table border="1" style="display: inline-table;"><tr><td>NULL</td><td>NULL</td></tr></table>	B	A	D	C	NULL	NULL
B	A													
D	C													
NULL	NULL													
B	A													
D	C													
NULL	NULL													

■Unicode character strings





In each Unicode character string storage image, "NULL" indicates a NULL code (0000H).

Character string to be stored	Image of storing character string data from D0	Image of storing character string data from word type label array arrayA[0]										
Null character string ("")	D0 <table border="1" style="display: inline-table;"><tr><td>NULL</td></tr></table>	NULL	arrayA[0] <table border="1" style="display: inline-table;"><tr><td>NULL</td></tr></table>	NULL								
NULL												
NULL												
ABCD	D0 <table border="1" style="display: inline-table;"><tr><td>A</td></tr></table> D1 <table border="1" style="display: inline-table;"><tr><td>B</td></tr></table> D2 <table border="1" style="display: inline-table;"><tr><td>C</td></tr></table> D3 <table border="1" style="display: inline-table;"><tr><td>D</td></tr></table> D4 <table border="1" style="display: inline-table;"><tr><td>NULL</td></tr></table>	A	B	C	D	NULL	arrayA[0] <table border="1" style="display: inline-table;"><tr><td>A</td></tr></table> arrayA[1] <table border="1" style="display: inline-table;"><tr><td>B</td></tr></table> arrayA[2] <table border="1" style="display: inline-table;"><tr><td>C</td></tr></table> arrayA[3] <table border="1" style="display: inline-table;"><tr><td>D</td></tr></table> arrayA[4] <table border="1" style="display: inline-table;"><tr><td>NULL</td></tr></table>	A	B	C	D	NULL
A												
B												
C												
D												
NULL												
A												
B												
C												
D												
NULL												

1.3 Execution Condition

Types of execution conditions

The following table lists the execution conditions of instructions.

Execution condition	Description ^{*1}
On	 An instruction is executed during on. It is executed only while the precondition of the instruction is on. When the precondition is off, the instruction is not executed.
Rising edge	 An instruction is executed one time when turned on. It is executed only once on the rising edge (off to on) of the precondition of the instruction and is no longer executed later even when the condition turns on.
Off	 An instruction is executed during off. It is executed only while the precondition of the instruction is off. When the precondition is on, the instruction is not executed.
Falling edge	 An instruction is executed one time when turned off. It is executed only once on the falling edge (on to off) of the precondition of the instruction and is no longer executed later even when the condition turns off.
Every scan	— An instruction is always executed regardless of whether the precondition of the instruction is on or off. When the precondition is off, the instruction performs off processing.

*1 When the program is described in structured text language (ST) or function block diagram/ladder diagram (FBD/LD), EN will be the precondition of the instruction.

Execution condition of each instruction

The execution condition varies depending on the instruction. For execution condition, refer to the details of each instruction in this manual.

When the program is described in structured text language (ST) or function block diagram/ladder diagram (FBD/LD), EN will be the execution condition. The instruction is executed only when EN is TRUE. The status of ENO will be the same as that of EN.

1.4 High-speed Instruction Processing

Subset processing

Subset processing can reduce the number of steps or speed up the instruction processing when the device and label specified by each operand of an instruction satisfy the specified conditions.

Instruction symbols and the number of operands do not change whether subset processing is applicable or not.

Instructions that support subset processing

For the availability of subset processing for CPU instructions, refer to the following.

📖 MELSEC iQ-R Programming Manual (CPU Module Instructions, Standard Functions/Function Blocks)

Operand condition

The conditions that the operands need to satisfy to enable subset processing are shown.

■When a device is specified in an operand

The following table lists the conditions that an operand which specifies a device needs to satisfy.

Data type of operand	Condition*1
Bit data	One of the following is satisfied. <ul style="list-style-type: none">• User device• Host CPU specification of CPU buffer memory access device (excluding index modification to "U3En")^{*2}• Other CPU modules specification of fixed scan communication area of CPU buffer memory access device^{*3}• File register• Local device• Refresh data register
Signed 16-bit data Unsigned 16-bit data Signed 32-bit data Unsigned 32-bit data	One of the following is satisfied. <ul style="list-style-type: none">• User device• Host CPU specification of CPU buffer memory access device (excluding index modification to "U3En")^{*2}• Other CPU modules specification of fixed scan communication area of CPU buffer memory access device^{*3}• Index register• File register• Local device• Refresh data register• Constant (decimal, hexadecimal)
Single-precision real number	One of the following is satisfied. <ul style="list-style-type: none">• User device• Host CPU specification of CPU buffer memory access device (excluding index modification to "U3En")^{*2}• Other CPU modules specification of fixed scan communication area of CPU buffer memory access device^{*3}• Index register• File register• Local device• Refresh data register• Constant (single-precision real number)

*1 Including the cases where bit numbers, digits, indirect addresses, or index-modified devices are specified

*2 True when U3En\G□, U3En\G□Zn, U3En\HG□, or U3En\HG□Zn is used in the CPU buffer memory access device of the host CPU module.

*3 True when U3En\HG□ or U3En\HG□Zn is used in the CPU buffer memory access device of another CPU module.

■When the label assigned a device is specified in an operand

The same conditions as those applicable when a device is specified in an operand apply.

■When the label assigned to each label area is specified in an operand

When the label assigned to a label area or latch label area is specified in an operand, any instruction which supports subset processing performs subset processing regardless of the data type of the operand. (Including the cases where bit numbers or digits are specified.)

1.5 Precautions on Programming

Errors common to instructions

The following table lists the conditions under which an error occurs when the instruction is executed.

Error content*1	Error code
An I/O number which is out of range (other than 000H to FFFH and 3E0H to 3E3H) is specified.	2800H
An I/O number which corresponds to no module is specified.	2801H
An I/O number of the module that cannot be specified by using the instruction is specified.	2803H
A network number which is out of range (1 to 239) is specified.	2804H
A network number which does not exist is specified.	2805H
<ul style="list-style-type: none"> The device or label specified by the instruction exceeds the available range. The file register is accessed while the file register is not set in the file setting of a CPU parameter or the file register to be used in the program is not set. 	2820H
<ul style="list-style-type: none"> The range of the buffer memory of the module specified by the instruction is exceeded. The module specified by the instruction does not have buffer memory. 	2823H

*1 For a contact instruction, an error is not detected but the operation result becomes no continuity.

Checking the ranges of instruction runtime devices and labels

Checking the ranges of devices and labels

When a device or label is specified in an instruction, no range check is performed, so a program needs to be created so that the operation result falls within the range of the relevant device or label.

If a range exceeding that of the relevant device or label is specified, no error is detected but data is written to other device or label areas.

However, an error (error code: 2820H) occurs if data is written to outside the areas.

The same applies if the label assigned to a device is specified in an instruction in the program.

Ex.

When a global device is specified and W0 is assigned after D1023 in the device/label memory

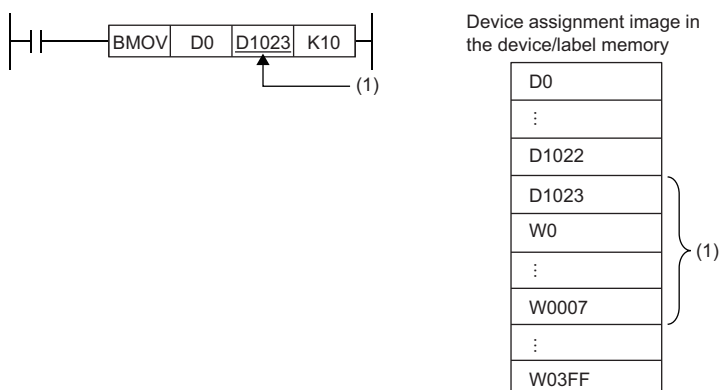

(1) The transfer destination is in the range corresponding to D1023 to D1032. Even though the range D1024 to D1032 does not exist, the data are written and the data in W0 to W0007 are overwritten.

Checking the range of file register

When a file register is specified in an instruction, a range check is performed, so a program needs to be created so that the operation result falls within the range of the relevant file register.

If a range exceeding that of the file register (ZR) is specified, an error (error code: 2820H) occurs.

If a range exceeding that of the file register of the block number used by the file register (R) is specified, an error (error code: 2820H) occurs.

Ex.

When a file register (ZR) is specified

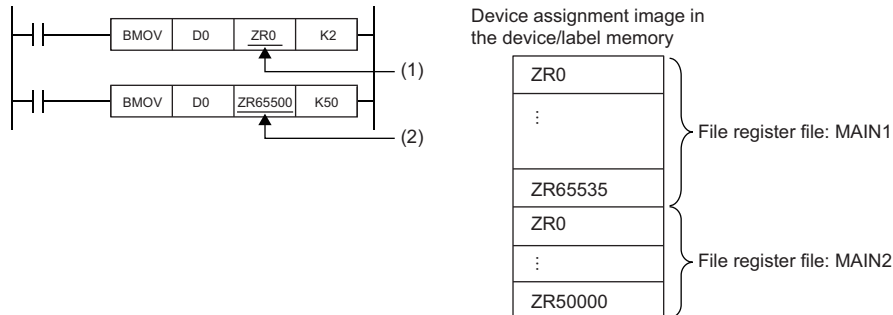

(1) The transfer destination is in the range of file register MAIN1. Data is written to ZR0 and ZR1.

(2) The transfer destination is out of the range of file register MAIN1. An error occurs because the area range of file register MAIN1 is exceeded.

Ex.

When a file register (R) is specified

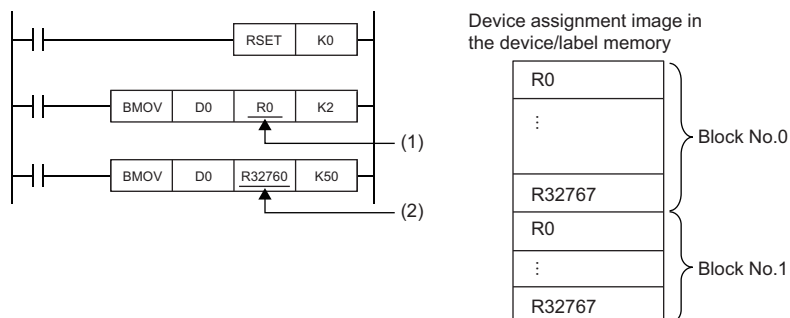

(1) The transfer destination is in the range of the R device of block number 0. Data is written to R0 and R1.

(2) The transfer destination is out of the range of the R device of block number 0. An error occurs because the area range of the R device of block number 0.

Operation when a long timer or long retentive timer device is used

When the data to be handled exceeds the width (32 bits) of the current value, the long timer or long retentive timer operates by using not only the area of the current value but also the areas of the previous value, contact, and coil.

Device	Configuration
Timer (T)	
Retentive timer (ST)	
Counter (C)	
Long timer (LT)	
Long retentive timer (LST)	
Long counter (LC)	

When the BMOV instruction is used to batch-transfer current values, current values alone cannot be batch-transferred. Batch-transfer the current values, contacts, and coils altogether and, after the batch transfer is finished, use only the current values. When the DMOV instruction is used to batch-transfer current values, repeat the transfer of the current values alone using the FOR to NEXT instruction.

Ex.

To batch-transfer the current values of the timer device

When the BMOV instruction is used, only current values are batch-transferred.

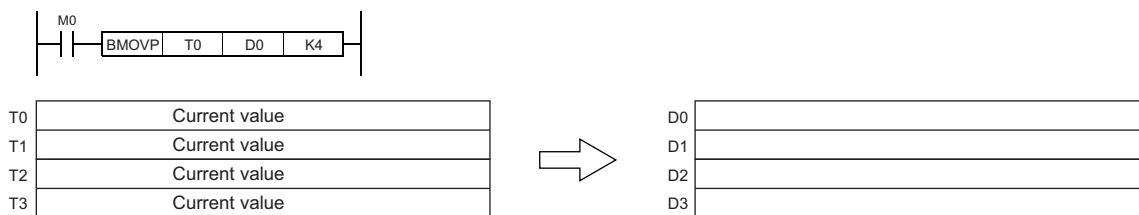

Ex.

To batch-transfer the current values of the long timer device

When the BMOV instruction is used, all current values, contacts, and coils are batch-transferred.

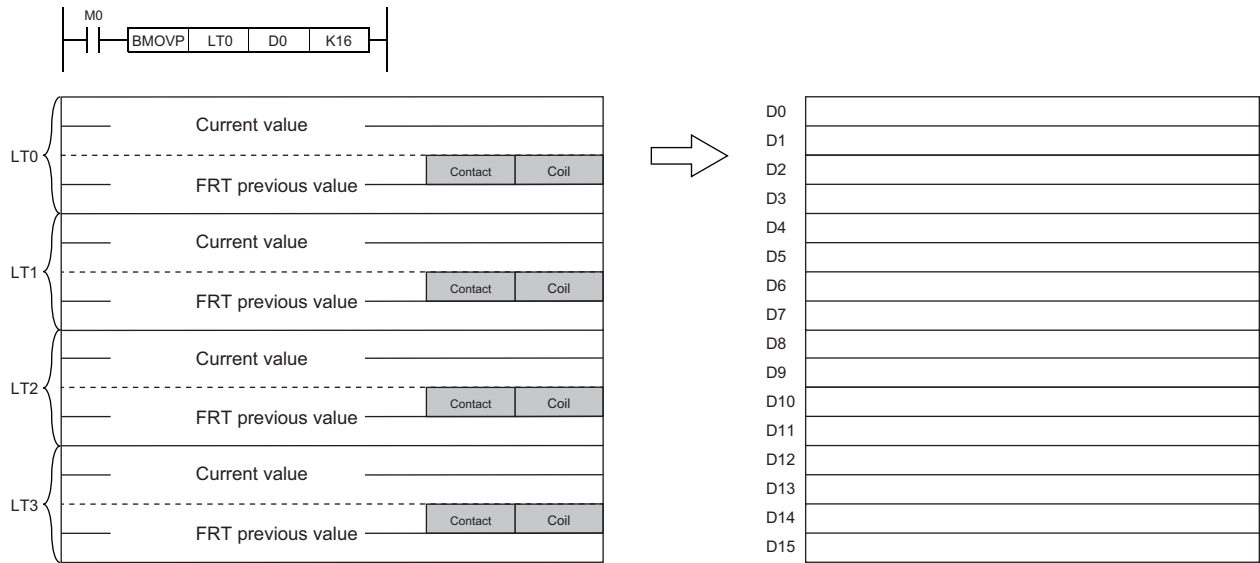

When the DMOV instruction is used, only current values are batch-transferred.

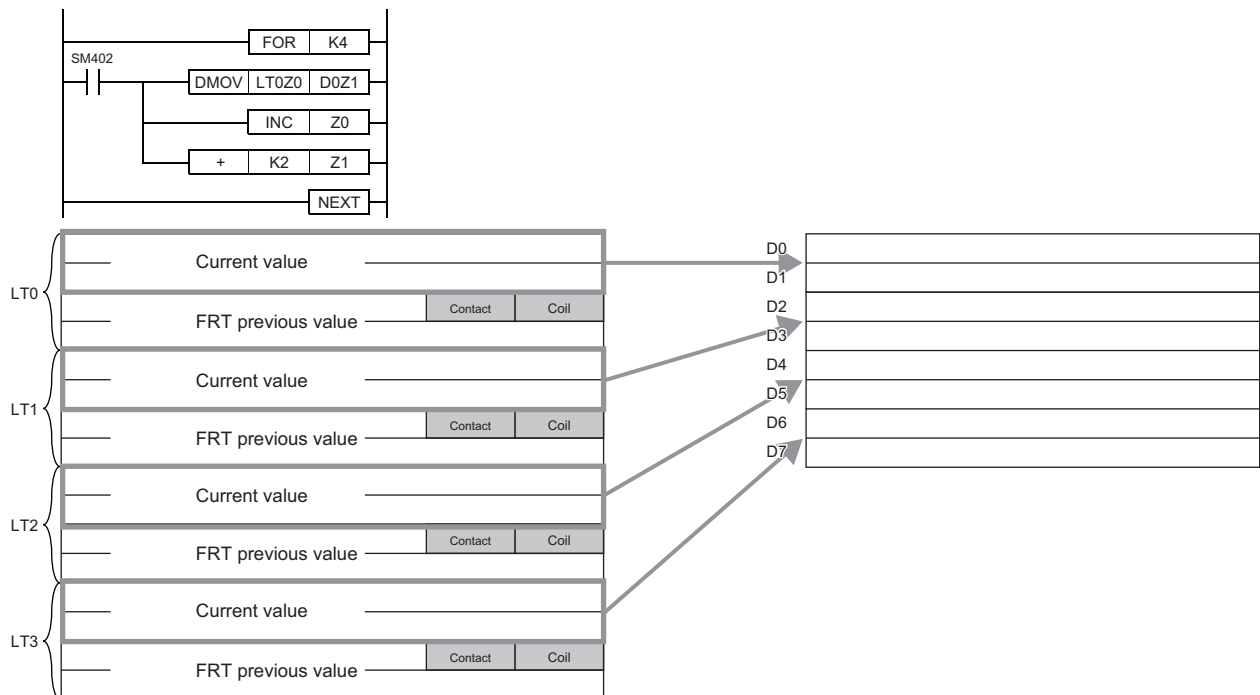

Restrictions on using file registers

When a file register is specified for the refresh device, note the following restrictions.

When a file register having the same name as a program is specified

If the use of a file register having the same name as a program is specified in the parameter, refresh cannot be performed correctly. When a file register having the same name of a program is used, data is refreshed by the file register having the same name of the program that has been set at the final number in the program settings.

To read or write refresh data, use the QDRSET instruction to switch to the corresponding file register and specify it.

If the file name or drive number is changed by the QDRSET instruction

If the file register file name or drive number is changed by the QDRSET instruction, the setting file is linked immediately before refresh.

To read or write refresh data, specify it in the setting file immediately before refresh.

When the block number is changed by the RSET instruction

When the block number is changed by the RSET instruction, note the following.

- Data is refreshed by the file register (R) of the new block number.
- Data is refreshed by the file register (R) of the block number immediately before refresh.

To read or write refresh data, specify the block number immediately before refresh.

PART 2

LISTS OF MODULE DEDICATED INSTRUCTIONS

This part consists of the following chapters.

2 MODULE DEDICATED INSTRUCTIONS

2 MODULE DEDICATED INSTRUCTIONS

How to read the list is shown below.

Item	Description
Instruction symbol	Indicates the instruction name.
Processing details	Indicates the overview of an instruction.
Reference	Indicates the reference of detailed information.

2.1 Ethernet, CC-Link IE, and MELSECNET/H Common Instructions

Link dedicated instructions

■ Reading data from the programmable controller on another station

Instruction symbol	Processing details	Reference
JP.READ	Reads data in units of words from a device in the programmable controller of another station.	Page 72 JP.READ, GP.READ
GP.READ		

■ Reading data from the programmable controller on another station (with notification)

Instruction symbol	Processing details	Reference
JP.SREAD	Reads data in units of words from a device in the programmable controller of another station. After the data reading is completed, the device of another station is turned on. (The other station can recognize that data has been read by the SREAD instruction.)	Page 81 JP.SREAD, GP.SREAD
GP.SREAD		

■ Writing data to the programmable controller on another station

Instruction symbol	Processing details	Reference
JP.WRITE	Writes data in units of words to a device in the programmable controller of another station.	Page 90 JP.WRITE, GP.WRITE
GP.WRITE		

■ Writing data to the programmable controller on another station (with notification)

Instruction symbol	Processing details	Reference
JP.SWRITE	Writes data in units of words to a device in the programmable controller of another station. After the data writing is completed, the device of another station is turned on. (The other station can recognize that data has been written by the SWRITE instruction.)	Page 100 JP.SWRITE, GP.SWRITE
GP.SWRITE		

■ Sending data to the programmable controller on another station

Instruction symbol	Processing details	Reference
JP.SEND	Sends data to the programmable controller of another station.	Page 111 JP.SEND, GP.SEND
GP.SEND		

■ Receiving data from the programmable controller on another station

Instruction symbol	Processing details	Reference
JP.RECV	Reads data received from the programmable controller of another station. (For the main routine program)	Page 121 JP.RECV, GP.RECV
GP.RECV		

■ Receiving data from the programmable controller on another station (for interrupt programs)

Instruction symbol	Processing details	Reference
G.RECVS	Reads data received from the programmable controller of another station. (For interrupt programs)	Page 128 G.RECVS, Z.RECVS
Z.RECVS		

■Reading data from the programmable controller (Q series-compatible)

Instruction symbol	Processing details	Reference
J.ZNRD	Reads data in units of words from a device in the programmable controller of another station.	Page 133 J(P).ZNRD
JP.ZNRD		

■Writing data to the programmable controller (Q series-compatible)

Instruction symbol	Processing details	Reference
J.ZNWR	Writes data in units of words to a device in the programmable controller of another station.	Page 138 J(P).ZNWR
JP.ZNWR		

■Remote RUN/STOP

Instruction symbol	Processing details	Reference
J.REQ	Executes remote RUN or STOP for the programmable controller of another station.	Page 143 J(P).REQ, G(P).REQ
JP.REQ		
G.REQ		
GP.REQ		

■Reading/writing clock data

Instruction symbol	Processing details	Reference
J.REQ	Reads/writes clock data from/to the programmable controller of another station.	Page 152 J(P).REQ, G(P).REQ
JP.REQ		
G.REQ		
GP.REQ		

CC-Link dedicated instructions

■Reading data from the target station

Instruction symbol	Processing details	Reference
J.RIRD	Reads the specified number of points of data from a device of the target station.	Page 161 J(P).RIRD, G(P).RIRD
JP.RIRD		
G.RIRD		
GP.RIRD		

■Writing data to the target station

Instruction symbol	Processing details	Reference
J.RIWT	Writes the specified number of points of data to a device of the target station.	Page 166 J(P).RIWT, G(P).RIWT
JP.RIWT		
G.RIWT		
GP.RIWT		

Restriction

- When the target station is the QSCPU, the following instructions cannot be used.
SEND, RECV, RECVS, J(P).ZNRD, J(P).ZNWR, and REQ (remote RUN/STOP)
- Data cannot be written from the CPU module on another station to the QSCPU by using the following instructions.
WRITE, SWRITE, REQ (reading/writing clock data), and RIWT
- If the CPU module on the target station is the AnUCPU or A2ASCPU(-S1) when the J(P).ZNRD or J(P).ZNWR instruction is executed, the CPU module must be the one with the following version or later.
AnUCPU: Version AY (manufactured in July 1995) or later
A2ASCPU(-S1): Version CP (manufactured in July 1995) or later

2.2 Ethernet Instructions

Open/close processing instructions

■Opening a connection

Instruction symbol	Processing details	Reference
GP.CONOPEN	Establishes (opens) a connection with an external device for data communication.	Page 171 GP.CONOPEN

■Closing a connection

Instruction symbol	Processing details	Reference
GP.CONCLOSE	Disconnects (closes) the connection from the external device during data communication.	Page 175 GP.CONCLOSE

■Opening a connection

Instruction symbol	Processing details	Reference
GP.OPEN	Establishes (opens) a connection with an external device for data communication.	Page 177 GP.OPEN, ZP.OPEN
ZP.OPEN		

■Closing a connection

Instruction symbol	Processing details	Reference
GP.CLOSE	Disconnects (closes) the connection from the external device during data communication.	Page 181 GP.CLOSE, ZP.CLOSE
ZP.CLOSE		

Socket communications instructions

■Reading receive data

Instruction symbol	Processing details	Reference
GP.SOCRCV	Reads receive data from the external device through socket communications or fixed buffer communications. This instruction is used in the main program.	Page 184 GP.SOCRCV

■Reading receive data (for interrupt programs)

Instruction symbol	Processing details	Reference
G.SOCRCVS	Reads receive data from the external device through socket communications or fixed buffer communications. This instruction is used in the interrupt program.	Page 186 G.SOCRCVS

■Sending data

Instruction symbol	Processing details	Reference
GP.SOCSND	Sends data to the external device through socket communications or fixed buffer communications. This instruction is used in the main program.	Page 188 GP.SOCSND

Fixed buffer communications instructions

■Reading receive data

Instruction symbol	Processing details	Reference
GP.BUFRCV	Reads receive data from the external device through fixed buffer communications. This instruction is used in the main program.	Page 190 GP.BUFRCV, ZP.BUFRCV
ZP.BUFRCV		

■ Reading receive data (for interrupt programs)

Instruction symbol	Processing details	Reference
G.BUFRCVS	Reads receive data from the external device through fixed buffer communications. This instruction is used in the interrupt program.	Page 193 G.BUFRCVS, Z.BUFRCVS
Z.BUFRCVS		

■ Sending data

Instruction symbol	Processing details	Reference
GP.BUFSND	Sends data to the external device through fixed buffer communications.	Page 195 GP.BUFSND, ZP.BUFSND
ZP.BUFSND		

Reinitializing the module

Instruction symbol	Processing details	Reference
G.UINI	Changes the setting details such as Ethernet operation settings or reinitializes the module.	Page 198 G(P).UINI, Z(P).UINI
GP.UINI		
Z.UINI		
ZP.UINI		

Executing the protocols registered for the predefined protocol support function

Instruction symbol	Processing details	Reference
GP.ECPRTCL	Executes the protocol that has been set by the predefined protocol support function.	Page 202 GP.ECPRTCL

Clearing error information

Instruction symbol	Processing details	Reference
GP.ERRCLEAR	Clears error information.	Page 207 GP.ERRCLEAR, ZP.ERRCLEAR
ZP.ERRCLEAR		

Reading error information

Instruction symbol	Processing details	Reference
GP.ERRRD	Reads error information.	Page 210 GP.ERRRD, ZP.ERRRD
ZP.ERRRD		

2.3 CC-Link IE TSN Instructions

Reading data from the remote station

Instruction symbol	Processing details	Reference
JP.REMFR ZP.REMFR	Reads data from the buffer memory area of the remote station in units of words (16-bit address specified).	Page 212 JP.REMFR, ZP.REMFR
JP.REMFRD	Reads data from the buffer memory area of the remote station in units of words (32-bit address specified).	Page 222 JP.REMFRD
GP.REMFRIP	Reads data from the buffer memory area of the remote station in units of words (target station IP address specified) (16-bit address specified).	Page 232 GP.REMFRIP
GP.REMFRDIP	Reads data from the buffer memory area of the remote station in units of words (target station IP address specified) (32-bit address specified).	Page 238 GP.REMFRDIP

Writing data to the remote station

Instruction symbol	Processing details	Reference
JP.REMTO ZP.REMTO	Writes data to the buffer memory area of the remote station in units of words (16-bit address specified).	Page 217 JP.REMTO, ZP.REMTO
JP.REMTOD	Writes data to the buffer memory area of the remote station in units of words (32-bit address specified).	Page 227 JP.REMTOD
GP.REMTOIP	Writes data to the buffer memory area of the remote station in units of words (target station IP address specified) (16-bit address specified).	Page 235 GP.REMTOIP
GP.REMTODIP	Writes data to the buffer memory area of the remote station in units of words (target station IP address specified) (32-bit address specified).	Page 241 GP.REMTODIP

Setting parameters

Instruction symbol	Processing details	Reference
G.CCPASET GP.CCPASET	Set parameters to the RJ71GN11-T2.	Page 244 G(P).CCPASET
G.CCPASET GP.CCPASET	Use the CCPASET or CCPASET instruction to set parameters in the following cases. <ul style="list-style-type: none"> To change parameters without resetting the CPU module To install more modules than can be set by the engineering tool 	Page 252 G(P).CCPASET

Own station number and IP address setting

Instruction symbol	Processing details	Reference
G.UINI GP.UINI Z.UINI ZP.UINI	Sets the station number and IP address to the own station where they are not set yet.	Page 257 G(P).UINI, Z(P).UINI

Sending an SLMP message

Instruction symbol	Processing details	Reference
J.SLMPSND	These instructions send an SLMP message to the SLMP-compatible device in the same network.	Page 260 J(P).SLMPSND, G(P).SLMPSND
JP.SLMPSND		
G.SLMPSND		
GP.SLMPSND		

Restriction

- The REMTO, REMTOD, REMTOIP, and REMTODIP instructions cannot be executed in local stations. Execute them in the master station.
- For the REMFR, REMFRD, REMFRIP, and REMFRDIP instructions, when the RJ71GN11-T2 with the firmware version of "03" or earlier, or "Communication mode" is set to "Unicast", the instructions cannot be executed in local stations. Execute them in the master station. When "Communication mode" is set to "Multicast", the instructions can be executed in either of the master station or the local stations.

2.4 CC-Link IE Controller Network and MELSECNET/H Instructions

Remote RUN

Instruction symbol	Processing details	Reference
J.RRUN	Sends a remote RUN request to the programmable controller of another station.	Page 270 J(P).RRUN, G(P).RRUN, Z(P).RRUN
JP.RRUN		
G.RRUN		
GP.RRUN		
Z.RRUN		
ZP.RRUN		

Remote STOP

Instruction symbol	Processing details	Reference
J.RSTOP	Sends a remote STOP request to the programmable controller of another station.	Page 275 J(P).RSTOP, G(P).RSTOP, Z(P).RSTOP
JP.RSTOP		
G.RSTOP		
GP.RSTOP		
Z.RSTOP		
ZP.RSTOP		

Reading clock data from the programmable controller on another station

Instruction symbol	Processing details	Reference
J.RTMRD	Reads clock data from the programmable controller of another station.	Page 280 J(P).RTMRD, G(P).RTMRD, Z(P).RTMRD
JP.RTMRD		
G.RTMRD		
GP.RTMRD		
Z.RTMRD		
ZP.RTMRD		

Writing clock data to the programmable controller on another station

Instruction symbol	Processing details	Reference
J.RTMWR	Writes clock data to the programmable controller of another station.	Page 285 J(P).RTMWR, G(P).RTMWR, Z(P).RTMWR
JP.RTMWR		
G.RTMWR		
GP.RTMWR		
Z.RTMWR		
ZP.RTMWR		

Setting the station number to own station

Instruction symbol	Processing details	Reference
G.UINI*1	Sets the station number of the own station.	Page 291 G(P).UINI, Z(P).UINI
GP.UINI*1		
Z.UINI*1		
ZP.UINI*1		

*1 The instructions cannot be used on the MELSECNET/H.

Restriction

- When the target station is QSCPU, the RRUN and RSTOP instructions cannot be used.
- The RTMWR instruction cannot write to QSCPU of other stations.

2.5 CC-Link IE Field Network Instructions

Reading data from the intelligent device station/remote device station

Instruction symbol	Processing details	Reference
JP.REMFR	Reads data from the buffer memory area of the intelligent device station or the remote device station in units of words (16-bit address specified).	Page 294 JP.REMFR, ZP.REMFR
ZP.REMFR		
JP.REMFRD	Reads data from the buffer memory area of the intelligent device station or the remote device station in units of words (32-bit address specified).	Page 304 JP.REMFRD

Writing data to the intelligent device station/remote device station

Instruction symbol	Processing details	Reference
JP.REMTO	Writes data to the buffer memory area of the intelligent device station or the remote device station in units of words (16-bit address specified).	Page 299 JP.REMTO, ZP.REMTO
ZP.REMTO		
JP.REMTOD	Writes data to the buffer memory area of the intelligent device station or the remote device station in units of words (32-bit address specified).	Page 309 JP.REMTOD

Reading the module model information of an intelligent device station

Instruction symbol	Processing details	Reference
J.SINFYRD	Reads the model names of modules and units used in an intelligent device station.	Page 314 J(P).SINFYRD, G(P).SINFYRD
JP.SINFYRD		
G.SINFYRD		
GP.SINFYRD		

Reading the module status information of an intelligent device station

Instruction symbol	Processing details	Reference
J.SINFSTRD	Reads the status information of modules and units used in an intelligent device station.	Page 320 J(P).SINFSTRD, G(P).SINFSTRD
JP.SINFSTRD		
G.SINFSTRD		
GP.SINFSTRD		

Setting parameters

Instruction symbol	Processing details	Reference
G.CCPASET	Sets parameters to the master, submaster, and local stations. Use the G(P).CCPASET instruction to set parameters in the following cases. • To change parameters without resetting the CPU module • To install more modules than can be set by the engineering tool	Page 326 G(P).CCPASET
GP.CCPASET		

Setting the station number to own station

Instruction symbol	Processing details	Reference
G.UINI	Sets the station number to the local station (own station). Use the engineering tool or UINI instruction to set network parameters excluding the station number.	Page 332 G(P).UINI, Z(P).UINI
GP.UINI		
Z.UINI		
ZP.UINI		

Sending an SLMP frame

Instruction symbol	Processing details	Reference
J.SLMPREQ	Sends an SLMP frame to the SLMP-compatible device in the same network. Data of the target station can be read/written and operated.	Page 335 J(P).SLMPREQ, G(P).SLMPREQ
JP.SLMPREQ		
G.SLMPREQ		
GP.SLMPREQ		

Restriction

The REMFR, REMTO, REMFRD, and REMTOD instructions cannot be executed in local stations. Execute them in the master station.

The submaster function can be executed only in the master operating station.

Use the own station master/submaster function operating status (SB004E) to apply an interlock so that the submaster function is executed only in the master operating station. (Master operating station when SB004E is off)

2.6 CC-Link Instructions

Reading data from the target station

Instruction symbol	Processing details	Reference
G.RIRD	Reads data of the specified number of points from the buffer memory area of the target station or the device in the CPU module on the target station.	Page 340 G(P).RIRD
GP.RIRD		

Writing data to the target station

Instruction symbol	Processing details	Reference
G.RIWT	Writes data of the specified number of points to the buffer memory area of the target station or the device in the CPU module on the target station.	Page 344 G(P).RIWT
GP.RIWT		

Reading data from the buffer memory of the specified intelligent device station

Instruction symbol	Processing details	Reference
G.RIRCV	Automatically performs handshake with the specified intelligent device station, and reads data from its buffer memory. The instructions can be used for communications with a module supporting a handshake signal such as AJ65BT-R2N.	Page 348 G(P).RIRCV
GP.RIRCV		

Writing data to the buffer memory of the specified intelligent device station

Instruction symbol	Processing details	Reference
G.RISEND	Automatically performs handshake with the specified intelligent device station, and writes data to its buffer memory. The instructions can be used for communications with a module supporting a handshake signal such as AJ65BT-R2N.	Page 351 G(P).RISEND
GP.RISEND		

Reading data from the automatic update buffer

Instruction symbol	Processing details	Reference
G.RIFR	Reads data from an automatic update or random access buffer. The instructions can be used for communications with a module having the automatic update buffer such as AJ65BT-R2N.	Page 354 G(P).RIFR
GP.RIFR		

Writing data to the automatic update buffer

Instruction symbol	Processing details	Reference
G.RITO	Writes data to an automatic update or random access buffer. The instructions can be used for communications with a module having the automatic update buffer such as AJ65BT-R2N.	Page 356 G(P).RITO
GP.RITO		

Setting network parameters

Instruction symbol	Processing details	Reference
G.RLPASET	Sets network parameters in the master station and starts up the data link.	Page 358 G(P).RLPASET
GP.RLPASET		

Performing a message transmission to a remote device station

Instruction symbol	Processing details	Reference
G.RDMSG	Reads/writes parameters from/to the remote device station and reads the status of the remote device station. The instructions can be executed to a remote device station, for example NZ2AW1C2AL, that supports the message transmission function.	Page 364 G(P).RDMSG
GP.RDMSG		

2.7 Serial Communication Instructions

Sending data using the on-demand function

Instruction symbol	Processing details	Reference
G.ONDEMAND	Sends data using the on-demand function of SLMP (MC protocol).	Page 370 G(P).ONDEMAND
GP.ONDEMAND		

Executing the protocols registered for the predefined protocol support function

Instruction symbol	Processing details	Reference
G.CPRTCL	Executes the protocol registered using the engineering tool.	Page 374 G(P).CPRTCL
GP.CPRTCL		

Sending data using the nonprocedural protocol

Instruction symbol	Processing details	Reference
G.OUTPUT	Sends data in user-specified message format through communications using the nonprocedural protocol.	Page 379 G(P).OUTPUT
GP.OUTPUT		

Receiving data using the nonprocedural protocol

Instruction symbol	Processing details	Reference
G.INPUT	Receives data in user-specified message format through communications using the nonprocedural protocol.	Page 383 G.INPUT

Sending data using the bidirectional protocol

Instruction symbol	Processing details	Reference
G.BIDOUT	Sends the specified amount of data through communications using the bidirectional protocol.	Page 386 G(P).BIDOUT
GP.BIDOUT		

Receiving data using the bidirectional protocol

Instruction symbol	Processing details	Reference
G.BIDIN	Receives data through communications using the bidirectional protocol.	Page 389 G(P).BIDIN
GP.BIDIN		

Reading the data send/receive status

Instruction symbol	Processing details	Reference
G.SPBUSY	Reads the status of data sent/received by using the serial communication instruction.	Page 392 G(P).SPBUSY
GP.SPBUSY		

Receiving data using the interrupt program

Instruction symbol	Processing details	Reference
Z.BUFRCVS	Receives data using the interrupt program through communications under control of the nonprocedural protocol or bidirectional protocol.	Page 394 Z.BUFRCVS

Sending data by using user frames

Instruction symbol	Processing details	Reference
G.PRR	Sends data with user frames according to the specification in the user frame specification area for sending, through communication with the nonprocedural protocol.	Page 397 G(P).PRR
GP.PRR		

Clearing receive data

Instruction symbol	Processing details	Reference
ZP.CSET	Clears the receive data area without stopping send processing by using the nonprocedural protocol.	Page 400 ZP.CSET

Registering/canceling the programmable controller CPU monitoring

Instruction symbol	Processing details	Reference
ZP.CSET	Registers programmable controller CPU monitoring to use the programmable controller CPU monitoring function, or cancels programmable controller CPU monitoring.	Page 403 ZP.CSET

Initial setting

Instruction symbol	Processing details	Reference
ZP.CSET	Sets the unit (word/byte) of data to be sent or received.	Page 408 ZP.CSET

Registering user frames

Instruction symbol	Processing details	Reference
G.PUTE	Registers user frames.	Page 412 G(P).PUTE
GP.PUTE		

Reading user frames

Instruction symbol	Processing details	Reference
G.GETE	Reads user frames.	Page 415 G(P).GETE
GP.GETE		

Switching the mode

Instruction symbol	Processing details	Reference
ZP.UINI	Switches the serial communication module mode, transmission specifications, and own station number.	Page 419 ZP.UINI

2.8 A/D Conversion Instructions

Switching the mode

Instruction symbol	Processing details	Reference
G.OFFGAN	Switches the analog module mode. <ul style="list-style-type: none">• Normal mode to offset/gain setting mode• Offset/gain setting mode to normal mode	Page 422 G(P).OFFGAN
GP.OFFGAN		

Reading the user range setting values

Instruction symbol	Processing details	Reference
G.OGLOAD	Reads the offset/gain setting values of the user range settings of an analog module into the CPU module.	Page 425 G(P).OGLOAD
GP.OGLOAD		

Restoring the user range setting values

Instruction symbol	Processing details	Reference
G.OGSTOR	Restores the offset/gain settings in the user range setting stored in the CPU module into an analog module.	Page 444 G(P).OGSTOR
GP.OGSTOR		

2.9 Positioning Instructions

Restoring the absolute position

Instruction symbol	Processing details	Reference
G.ABRST1	Restores the absolute position of specified axis.	Page 464 G.ABRST□, Z.ABRST□
G.ABRST2		
G.ABRST3		
G.ABRST4		
Z.ABRST1		
Z.ABRST2		
Z.ABRST3		
Z.ABRST4		

Starting the positioning

Instruction symbol	Processing details	Reference
GP.PSTRT1	Starts positioning of the specified axis.	Page 468 GP.PSTRT□, ZP.PSTRT□
GP.PSTRT2		
GP.PSTRT3		
GP.PSTRT4		
ZP.PSTRT1		
ZP.PSTRT2		
ZP.PSTRT3		
ZP.PSTRT4		

Teaching

Instruction symbol	Processing details	Reference
GP.TEACH1	Performs teaching for the specified axis.	Page 471 GP.TEACH□, ZP.TEACH□
GP.TEACH2		
GP.TEACH3		
GP.TEACH4		
ZP.TEACH1		
ZP.TEACH2		
ZP.TEACH3		
ZP.TEACH4		

Backing up module data (writing data to the flash ROM)

Instruction symbol	Processing details	Reference
GP.PFWRT	Writes the positioning data and block start data in the buffer memory to the flash ROM.	Page 474 GP.PFWRT, ZP.PFWRT
ZP.PFWRT		

Initializing the module

Instruction symbol	Processing details	Reference
GP.PINIT	Initializes the setting data in the buffer memory and flash ROM.	Page 477 GP.PINIT, ZP.PINIT
ZP.PINIT		

2.10 High Speed Data Logger Module Instructions

File access instructions

■Recipe write

Instruction symbol	Processing details	Reference
Z.RCPWRITE	Writes device values of the CPU module to the specified recipe file in the SD memory card.	Page 480 Z(P).RCPWRITE
ZP.RCPWRITE		

■Recipe read

Instruction symbol	Processing details	Reference
Z.RCPREAD	Reads device values of the specified recipe file in the SD memory card to the CPU module.	Page 484 Z(P).RCPREAD
ZP.RCPREAD		

2.11 C Intelligent Function Module Instructions

User function execution instruction

■User function execution

Instruction symbol	Processing details	Reference
G.CEEXECUTE	Instructs to execute a function for the pre-registered function.	Page 487 G(P).CEEXECUTE
GP.CEEXECUTE		

Data analysis function execution instruction

■Digital filter operation

Instruction symbol	Processing details	Reference
G.DIGIFLTR	This instruction performs digital filter operation for the specified wave.	Page 491 G(P).DIGIFLTR
GP.DIGIFLTR		

■Envelope calculation

Instruction symbol	Processing details	Reference
G.ENVCALC	This instruction calculates the envelope of the specified wave.	Page 498 G(P).ENVCALC
GP.ENVCALC		

■FFT spectrum operation

Instruction symbol	Processing details	Reference
G.FFTSPECT	This instruction performs spectrum calculation using fast Fourier transform (FFT) for the specified wave.	Page 502 G(P). FFTSPECT
GP.FFTSPECT		

Statistical analysis function execution instruction

■Least-squares operation

Instruction symbol	Processing details	Reference
G.LEASTSQ	This instruction calculates a coefficient and a constant of a polynomial and a multiple correlation coefficient using a least-squares method for the specified array.	Page 507 G(P).LEASTSQ
GP.LEASTSQ		

■Determination of unit space

Instruction symbol	Processing details	Reference
G.MTUNIT	This instruction determines a unit space that is used in the MT method based on the specified normal data.	Page 512 G(P).MTUNIT
GP.MTUNIT		

■Mahalanobis distance calculation of signal data

Instruction symbol	Processing details	Reference
G.MTMD	This function calculates a Mahalanobis distance of the specified input data.	Page 518 G(P).MTMD
GP.MTMD		

■Multiple regression analysis

Instruction symbol	Processing details	Reference
G.MULTIRG	This function calculates coefficient, constant, and regression statistics for multiple regression analysis.	Page 524 G(P).MULTIRG
GP.MULTIRG		

2.12 DeviceNet Instructions

Master function receive data area read

Instruction symbol	Processing details	Reference
G.DNTMRD	Reads the data from the master function receive data area of the specified module maintaining data consistency.	Page 531 G.DNTMRD

Master function transmit data area write

Instruction symbol	Processing details	Reference
G.DNTMWR	Writes the data to the master function transmit data area of the specified module maintaining data consistency.	Page 533 G.DNTMWR

Slave function receive data area read

Instruction symbol	Processing details	Reference
G.DNTSRD	Reads the data from the slave function receive data area of the specified module maintaining data consistency.	Page 535 G.DNTSRD

Slave function transmit data area write

Instruction symbol	Processing details	Reference
G.DNTSWR	Writes the data to the slave function transmit data area of the specified module maintaining data consistency.	Page 537 G.DNTSWR

MEMO

This part consists of the following chapters.

3 Ethernet, CC-Link IE, AND MELSECNET/H COMMON INSTRUCTIONS

4 Ethernet INSTRUCTIONS

5 CC-Link IE TSN INSTRUCTIONS

6 CC-Link IE Controller Network AND MELSECNET/H COMMON INSTRUCTIONS

7 CC-Link IE Field Network INSTRUCTIONS

8 CC-Link INSTRUCTIONS

9 SERIAL COMMUNICATION INSTRUCTIONS

10 A/D CONVERSION INSTRUCTIONS

11 POSITIONING INSTRUCTIONS

12 HIGH SPEED DATA LOGGER MODULE INSTRUCTIONS

13 C INTELLIGENT FUNCTION MODULE INSTRUCTIONS

14 DeviceNet INSTRUCTIONS

3 Ethernet, CC-Link IE, AND MELSECNET/H COMMON INSTRUCTIONS

Point

This chapter describes the instructions used commonly by MELSEC iQ-R series modules. When using MELSEC-Q series modules, refer to the manual for each module used and create programs.

For precautions when using modules, refer to the following.

 MELSEC iQ-R Module Configuration Manual

Availability of each module

The following table summarizes the availability of each module for the instructions explained in this chapter.

○: Available, ×: Not available

Instruction symbol	Availability					Reference
	Ethernet module	CC-Link IE TSN module	CC-Link IE Controller Network module	CC-Link IE Field Network module	MELSECNET/H module	
READ	○	○	○	○	○	Page 72 JP.READ, GP.READ
SREAD	○	○	○	○	○	Page 81 JP.SREAD, GP.SREAD
WRITE	○	○	○	○	○	Page 90 JP.WRITE, GP.WRITE
SWRITE	○	○	○	○	○	Page 100 JP.SWRITE, GP.SWRITE
SEND	○	○	○	○	○	Page 111 JP.SEND, GP.SEND
RECV	○	○	○	○	○	Page 121 JP.RECV, GP.RECV
RECVS	○	×	○	○	○	Page 128 G.RECVS, Z.RECVS
J(P).ZNRD	○	×	○	×	○	Page 133 J(P).ZNRD
J(P).ZNWR	○	×	○	×	○	Page 138 J(P).ZNWR
REQ	○	○	○	○	○	Page 143 J(P).REQ, G(P).REQ Page 152 J(P).REQ, G(P).REQ
RIRD	×	×	○	○	×	Page 161 J(P).RIRD, G(P).RIRD
RIWT	×	×	○	○	×	Page 166 J(P).RIWT, G(P).RIWT
RRUN	○	×	○	×	○	Page 270 J(P).RRUN, G(P).RRUN, Z(P).RRUN
RSTOP	○	×	○	×	○	Page 275 J(P).RSTOP, G(P).RSTOP, Z(P).RSTOP
RTMRD	○	×	○	×	○	Page 280 J(P).RTMRD, G(P).RTMRD, Z(P).RTMRD
RTMWR	○	×	○	×	○	Page 285 J(P).RTMWR, G(P).RTMWR, Z(P).RTMWR

Target networks and target station types

The Ethernet, CC-Link IE, and MELSECNET/H common instructions can access to a station on a network other than the own station network. (Excluding the RIRD and RIRW instructions)

The following table lists the target stations of each instruction.

Instruction symbol	Target station (another station)	
	Target network	Target station type
READ SREAD	<ul style="list-style-type: none"> • Ethernet • CC-Link IE TSN • CC-Link IE Controller Network • CC-Link IE Field Network • MELSECNET/H • MELSECNET/10 	<ul style="list-style-type: none"> • RCPU • QCPU • LCPU • QSCPU • QnACPU • Intelligent device station
WRITE SWRITE	<ul style="list-style-type: none"> • Ethernet • CC-Link IE TSN • CC-Link IE Controller Network • CC-Link IE Field Network • MELSECNET/H • MELSECNET/10 	<ul style="list-style-type: none"> • RCPU • QCPU • LCPU • QnACPU • Intelligent device station
SEND RECV RECVS	<ul style="list-style-type: none"> • Ethernet • CC-Link IE TSN^{*3} • CC-Link IE Controller Network • CC-Link IE Field Network • MELSECNET/H • MELSECNET/10 	<ul style="list-style-type: none"> • RCPU • QCPU • LCPU • QnACPU • Interface board for personal computer^{*1}
J(P).ZNRD J(P).ZNWR	<ul style="list-style-type: none"> • Ethernet • CC-Link IE Controller Network • MELSECNET/H • MELSECNET/10 	<ul style="list-style-type: none"> • QCPU • LCPU • QnACPU • ACPU
REQ	<ul style="list-style-type: none"> • Ethernet • CC-Link IE TSN • CC-Link IE Controller Network • CC-Link IE Field Network • MELSECNET/H • MELSECNET/10 	<ul style="list-style-type: none"> • RCPU • QCPU • LCPU • QSCPU • QnACPU • Ethernet adapter module
RIRD RIWT	<ul style="list-style-type: none"> • CC-Link IE Controller Network • CC-Link IE Field Network^{*2} 	<ul style="list-style-type: none"> • CC-Link IE Controller Network device • CC-Link IE Field Network device

*1 These instructions can access the following personal computer interface boards having the SEND/RECV functions. CC-Link IE Field Network interface board, CC-Link IE Controller Network interface board, MELSECNET/H interface board, and MELSECNET/10 interface board

*2 These instructions cannot be executed from the local station to the intelligent device station. Execute them in the master station.

*3 RECVS instructions cannot be used.

Range of available channels

The range of own station channels that can be specified by the Ethernet, CC-Link IE, and MELSECNET/H common instructions varies depending on the module.

The following table summarizes the ranges of channels that can be specified by instructions for individual modules.

Available channels

Instruction		RJ71GN11-T2	RJ71GP21(S)-SX	RJ71GF11-T2	RJ71LP21-25
Link dedicated instruction	READ, SREAD, WRITE, SWRITE	1 to 8	1 to 10	1, 2	1 to 8
	SEND, RECV, RECVS, REQ	1 to 8 ^{*3}	1 to 8	1, 2	1 to 8 ^{*4}
	RRUN, RSTOP, RTMRD, RTMWR	—	1 to 8	—	1 to 8
Remote instruction	REMF, REMTO, REMFRD, REMTOD	1 to 32	—	1 to 32	—
System configuration instruction	SINFYRD, SINFSTRD	—	—	1 to 32	—

Instruction		RJ71EN71 ^{*1}				
		RJ71EN71(E+E)		RJ71EN71(E+CCIEC)		RJ71EN71(CCIEC)
		PORT1	PORT2	PORT1	PORT2	PORT1/PORT2
Link dedicated instruction	READ, SREAD, WRITE, SWRITE	1 to 8	11 to 18	1 to 8	11 to 18	1 to 8
	SEND, RECV, RECVS, REQ	1 to 8	11 to 18	1 to 8	11 to 18	1 to 8
	RRUN, RSTOP, RTMRD, RTMWR	—	—	—	11 to 18	1 to 8
Remote instruction	REMF, REMTO, REMFRD, REMTOD	—	—	—	—	—
System configuration instruction	SINFYRD, SINFSTRD	—	—	—	—	—

Instruction		RJ71EN71 ^{*1}			
		RJ71EN71(E+CCIEF)		RJ71EN71(CCIEF)	RJ71EN71(Q)
		PORT1	PORT2	PORT1/PORT2	PORT1
Link dedicated instruction	READ, SREAD, WRITE, SWRITE	1 to 8	11 to 18	1 to 8	1 to 8
	SEND, RECV, RECVS, REQ	1 to 8	11 to 18	1 to 8	1 to 8
	RRUN, RSTOP, RTMRD, RTMWR	—	—	—	—
Remote instruction	REMF, REMTO, REMFRD, REMTOD	—	1 to 32	1 to 32	—
System configuration instruction	SINFYRD, SINFSTRD	—	1 to 32	1 to 32	—

Instruction		RnENCPU (network part) ^{*2}		
		_RJ71EN71(E+CCIEC)		_RJ71EN71(CCIEC)
		PORT1	PORT2	PORT1/PORT2
Link dedicated instruction	READ, SREAD, WRITE, SWRITE	1 to 8	11 to 18	1 to 8
	SEND, RECV, RECVS, REQ	1 to 8	11 to 18	1 to 8
	RRUN, RSTOP, RTMRD, RTMWR	—	11 to 18	1 to 8
Remote instruction	REMF, REMTO, REMFRD, REMTOD	—	—	—
System configuration instruction	SINFYRD, SINFSTRD	—	—	—

Instruction		RnENCPU (network part) ^{*2}		
		_RJ71EN71(E+CCIEF)		_RJ71EN71(CCIEF)
		PORT1	PORT2	PORT1/PORT2
Link dedicated instruction	READ, SREAD, WRITE, SWRITE	1 to 8	11 to 18	1 to 8
	SEND, RECV, RECVS, REQ	1 to 8	11 to 18	1 to 8
	RRUN, RSTOP, RTMRD, RTMWR	—	—	—
Remote instruction	REMF, REMTO, REMFRD, REMTOD	—	1 to 32	1 to 32
System configuration instruction	SINFYRD, SINFSTRD	—	1 to 32	1 to 32

*1 The range of channels of an Ethernet module varies depending on the combination of network types at PORT1 and PORT2.

- RJ71EN71(E+E): PORT1 and PORT2 are "Ethernet".
- RJ71EN71(E+CCIEC): PORT1 is "Ethernet" and PORT2 is "CC-Link IE Controller Network".
- RJ71EN71(CCIEC): PORT1 and PORT2 are "CC-Link IE Controller Network".
- RJ71EN71(E+CCIEF): PORT1 is "Ethernet" and PORT2 is "CC-Link IE Field Network".
- RJ71EN71(CCIEF): PORT1 and PORT2 are "CC-Link IE Field Network".
- RJ71EN71(Q): PORT1 is "Q-compatible Ethernet". (PORT2 cannot be used.)

*2 The range of channels of the RnENCPU (network part) varies depending on the combination of network types at PORT1 and PORT2.

- _RJ71EN71(E+CCIEC): PORT1 is "Ethernet" and PORT2 is "CC-Link IE Controller Network".
- _RJ71EN71(CCIEC): PORT1 and PORT2 are "CC-Link IE Controller Network".
- _RJ71EN71(E+CCIEF): PORT1 is "Ethernet" and PORT2 is "CC-Link IE Field Network".
- _RJ71EN71(CCIEF): PORT1 and PORT2 are "CC-Link IE Field Network".

*3 RECVS instructions cannot be used.

*4 The SEND instruction of the MELSECNET/H module can specify the logical channel number (1 to 64) to the target station storage channel.

■Corresponding Network type

Instruction		Ethernet	Q-compatible Ethernet	CC-Link IE TSN	CC-Link IE Controller Network	CC-Link IE Field Network	MELSECNET/H
Link dedicated instruction	READ, SREAD, WRITE, SWRITE	○	○	○	○	○	○
	SEND, RECV, RECVS, REQ	○	○	○*1	○	○	○
	RRUN, RSTOP, RTMRD, RTMWR	—	—	—	○	—	○
Remote instruction	REMF, REMTO, REMFRD, REMTOD	—	—	○	—	○	—
System configuration instruction	SINFYRD, SINFSTRD	—	—	—	—	○	—

*1 RECVS instructions cannot be used.

When executing multiple instructions concurrently

When executing multiple Ethernet, CC-Link IE, and MELSECNET/H common instructions concurrently, specify the own station channels as follows.

■When executing multiple link dedicated instructions concurrently

Specify a separate channel for each instruction. If a same channel is specified for multiple link dedicated instructions, the instructions cannot be executed concurrently. When specifying a same channel for multiple link dedicated instructions, execute one instruction first, and then the next one after the execution completion of the former instruction.

■When executing multiple remote instructions concurrently

Specify a separate channel for each instruction. If a same channel is specified for multiple remote instructions, the instructions cannot be executed concurrently. When specifying a same channel for multiple remote instructions, execute one instruction first, and then the next one after the execution completion of the former instruction.

■When executing multiple system configuration instructions concurrently

Specify a separate channel for each instruction. If a same channel is specified for multiple system configuration instructions, the instructions cannot be executed concurrently. When specifying a same channel for multiple system configuration instructions, execute one instruction first, and then the next one after the execution completion of the former instruction.

■When executing a link dedicated instruction, a remote instruction, and a system configuration instruction concurrently

A link dedicated instruction, a remote instruction, and a system configuration instruction can be executed concurrently even if a same channel is specified for all of them, because the channels for these instructions are independent from each other.

Ex.

When accessing multiple other stations from the own station concurrently

For the READ instruction and the WRITE instruction, specify a separate own station channel for each request destination.

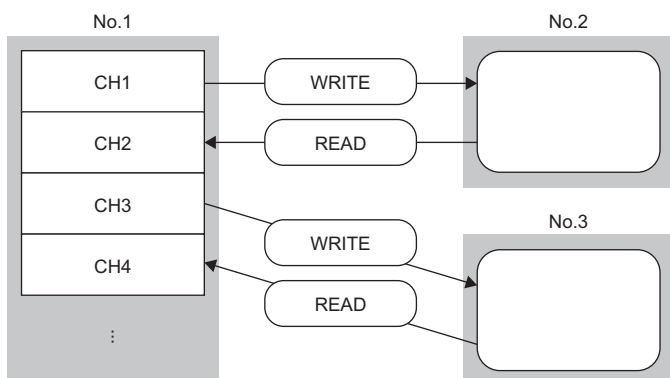

No.1: Station number 1 (own station)

No.2: Station number 2 (other station)

No.3: Station number 3 (other station)

CH: Channel

Ex.

When accessing the other station from the own station and vice versa

For the SEND instruction and the RECV instruction, specify a separate own station channel for each link dedicated instruction.

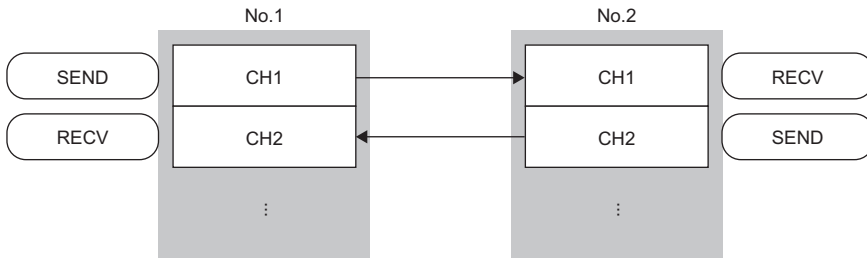

No.1: Station number 1 (own station)
 No.2: Station number 2 (other station)
 CH: Channel

Ex.

When concurrently executing multiple link dedicated instructions where a same channel is specified.

The link dedicated instructions are not executed concurrently.

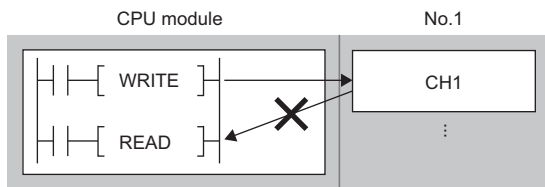

No.1: Station number 1 (own station)
 CH: Channel

Ex.

When using a link dedicated instruction, a remote instruction, and a system configuration instruction concurrently

A link dedicated instruction (1), a remote instruction (2), and a system configuration instruction (3) can be executed concurrently with a same channel specified for all of them, because the channels for these instructions are independent from each other.

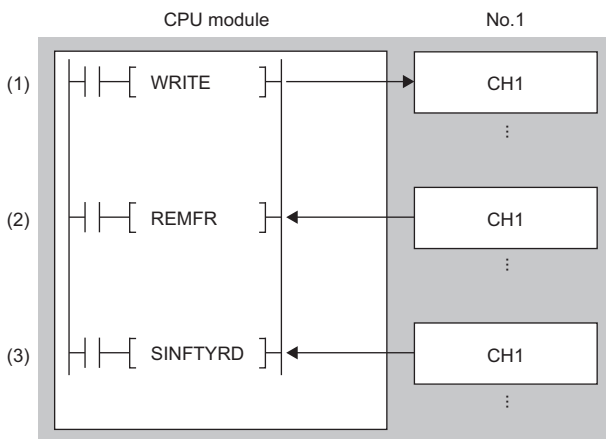

No.1: Station number 1 (own station)
 CH: Channel

Specifications of character string data specified by link dedicated instructions

Some operands specified in link dedicated instructions are specified in character strings. The following table summarizes the specifications of character string data specified.

Instruction symbol	Applicable operand	Specifications of character string data
READ	(s2)	<p>■Specifiable device types</p> <ul style="list-style-type: none"> • Word device: D, W, SW, SD, T, C, ST, ZR, R • Digit-specified bit device: X, Y, M, L, B, F, SB, SM • Digit-specified word device and bit device index modification: Z, ZZ <p>■ASCII string specifications</p> <ul style="list-style-type: none"> • An ASCII string can consist of a maximum of 32 characters. (Specify NULL as the termination character.) • ASCII strings are zero-suppressed. (Example: D1 and D001 are handled the same.) • ASCII strings are case-sensitive. <p>■Precautions</p> <p>Digit-specified bit devices can be specified only when the following conditions are all satisfied.</p> <ul style="list-style-type: none"> • The device number is a multiple of 16 (10H). • The number of specified digits is 4 (K4). <p>An instruction specifying bit devices by digits can be executed only when the target station is RCP, basic model QCPU, universal model QCPU, or LCP. If an instruction uses a digit specification for other types of CPU modules, an abnormal response is returned from the target station and the instruction is completed with an error. (The network module does not detect an error during execution of the instruction.)</p> <p>The target device of an instruction executed in index modification mode is determined by the value of the index register of the own station.</p>
SREAD	(s2)	
WRITE	(d1)	
SWRITE	(d1)	
SREAD	(d3)	<p>■Specifiable device types</p> <ul style="list-style-type: none"> • Bit specification of word device: D, W, SW, SD, ZR, R • Bit device: X, Y, M, L, B, F, SB, SM • Bit device index modification: Z, ZZ <p>■ASCII string specifications</p> <ul style="list-style-type: none"> • An ASCII string can consist of a maximum of 32 characters. (Specify NULL as the termination character.) • ASCII strings are zero-suppressed. (Example: D1 and D001 are handled the same.) • ASCII strings are case-sensitive. <p>■Precautions</p> <p>The target device of an instruction executed in index modification mode is determined by the value of the index register of the own station.</p>
SWRITE	(d3)	
J(P).ZNRD	(s2)	<p>■Specifiable device types</p> <ul style="list-style-type: none"> • Word device: T, C, D, W • Word device index modification: Z, ZZ <p>■ASCII string specifications</p> <ul style="list-style-type: none"> • An ASCII string can consist of a maximum of 32 characters. (Specify NULL as the termination character.) • ASCII strings are zero-suppressed. (Example: D1 and D001 are handled the same.) • ASCII strings are case-sensitive. <p>■Precautions</p> <p>The target device of an instruction executed in index modification mode is determined by the value of the index register of the own station.</p>
J(P).ZNWR	(d1)	

For how to specify a character string, refer to the following.

 Page 33 Notation of character string

Calculating the value to be set for the arrival monitoring time

The following shows the method for determining the value to be set for the arrival monitoring time specified by link dedicated instructions.

■Outline of communication processing for link dedicated instructions

When a link dedicated instruction is executed in the same network, the communication process at occurrence of retransmission is as follows.

Ex.

The READ instruction is executed in the same network.

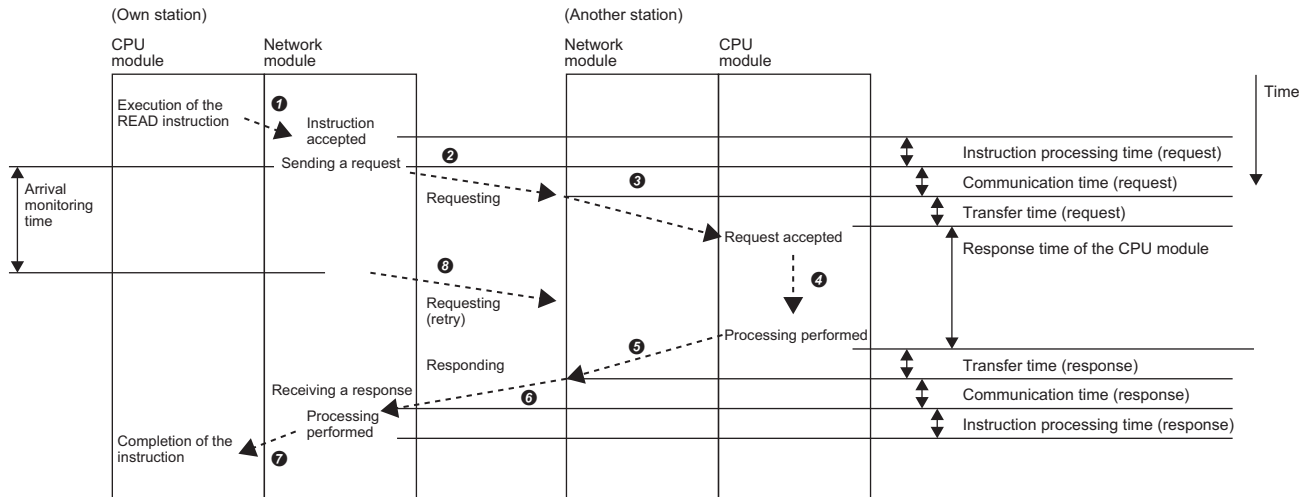

- ① The CPU module executes the instruction and the network module accepts the instruction.
- ② The own station network module sends the request to another station.
- ③ Another station network module receives the request and relays it to the CPU module.
- ④ The CPU module processes the request.
- ⑤ Another station network module relays the response from the CPU module.
- ⑥ Another station network module sends the response to the own station.
- ⑦ The own station network module receives the response and processes it.
- ⑧ The own station network module requests retransmission if the response does not arrive within the arrival monitoring time.

■Calculating the arrival monitoring time

The value to be set for the arrival monitoring time must be greater than the time taken from ② to ⑦.

[Calculation formula]

$$\text{Arrival monitoring time} > Tc_req + Tt_req + Tcpu + Tt_ans + Tc_ans + Tnet$$

Item	Description	Details
Tc_req	Communication time (request)	For a CC-Link IE TSN, CC-Link IE Controller Network, CC-Link IE Field Network, or MELSECNET/H, calculate these items based on the link scan time. For concurrent multiple transmissions including other transient transmissions, further increase the time in units of link scans. The link scan time can be checked with the diagnostic window of each network. When Ethernet is used, the time varies depending on the amount of data and network load ratio (line congestion). Calculate the time by adding the delay of the switching hub and the line congestion to 1ms.
Tc_ans	Communication time (response)	
Tt_req	Network module relay time (request)	Set 20ms in total.
Tt_ans	Network module relay time (response)	
Tnet	Network module instruction processing time (response)	
Tcpu	CPU module response time	This time varies depending on the CPU module type and operating status. Calculate the response time by "sequence scan time" × "number of times the device/label access service is performed per scan". For the scan time and device/label access service processing, refer to the following. 📖 MELSEC iQ-R CPU Module User's Manual (Application)

3.1 Link Dedicated Instructions

Reading data from the programmable controller on another station

JP.READ, GP.READ



These instructions read data from a device in the programmable controller of another station. (in units of words)

Ladder	ST
	<pre>ENO:=JP_READ(EN,J,s1,s2,d1,d2); ENO:=GP_READ(EN,U,s1,s2,d1,d2);</pre>

FBD/LD

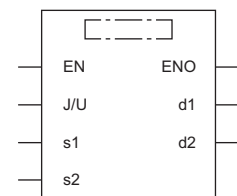

Execution condition

Instruction	Execution condition
JP.READ GP.READ	

Setting data

Description, range, data type

Operand	Description	Range	Data type	Data type (label)	
(J/U)	JP.READ	(J): Own station network number	1 to 239	16-bit unsigned binary	ANY16
	GP.READ	(U): Start I/O number (first three digits in four-digit hexadecimal representation) of own station or own node	00H to FEH	16-bit unsigned binary	ANY16
(s1)	Own station start device where control data is stored	Refer to the control data.	Device name	ANY16 ^{*1}	
(s2)	Target station start device where the data to be read is stored	—	String ^{*2}	ANYSTRING_SINGLE ^{*2}	
(d1)	Own station start device (a continuous area for the length of the read data) for storing the data that has been read	—	Device name	ANY16 ^{*1}	
(d2)	Device of the own station, which turns on for one scan upon completion of the instruction. When the instruction completes with an error, (d2)+1 also turns on.	—	Bit	ANYBIT_ARRAY (Number of elements: 2)	
EN	Execution condition	—	Bit	BOOL	
ENO	Execution result	—	Bit	BOOL	

*1 When specifying data with a label, define the array so that an area required for operation can be secured, and specify the array label element.

*2 For the specifications of the string data to be specified, refer to the following.

Page 70 Specifications of character string data specified by link dedicated instructions

■ Applicable devices

Operand		Bit		Word			Double word		Indirect specification	Constant			Others	
		X, Y, M, L, SM, F, B, SB, FX, FY	J□□	T, ST, C, D, W, SD, SW, FD, R, ZR, RD	U□\G□, J□\□, U3E□\(\H)G□	Z	LT, LST, LC	LZ		K, H	E	\$	J	U
(J/U)	JP.READ	—	—	—	—	—	—	—	—	—	—	—	○	—
	GP.READ	—	—	○	—	—	—	—	○	○	—	—	—	○
(s1)		—	—	○*2	—	—	—	—	○	—	—	—	—	—
(s2)		—	—	—	—	—	—	—	—	—	—	○	—	—
(d1)		—	—	○*2	—	—	—	—	○	—	—	—	—	—
(d2)		○*1	—	○*3	—	—	—	—	—	—	—	—	—	—

*1 FX and FY cannot be used.

*2 FD cannot be used.

*3 T, ST, C, and FD cannot be used.

Point

- The READ instruction cannot be executed when the target station is ACPU.
- Specify the own station start device (d1) for storing the data that has been read, by considering the range in which the data that has been read can be stored.

(Example: When areas D150 and after in the own station CPU module are already in use)

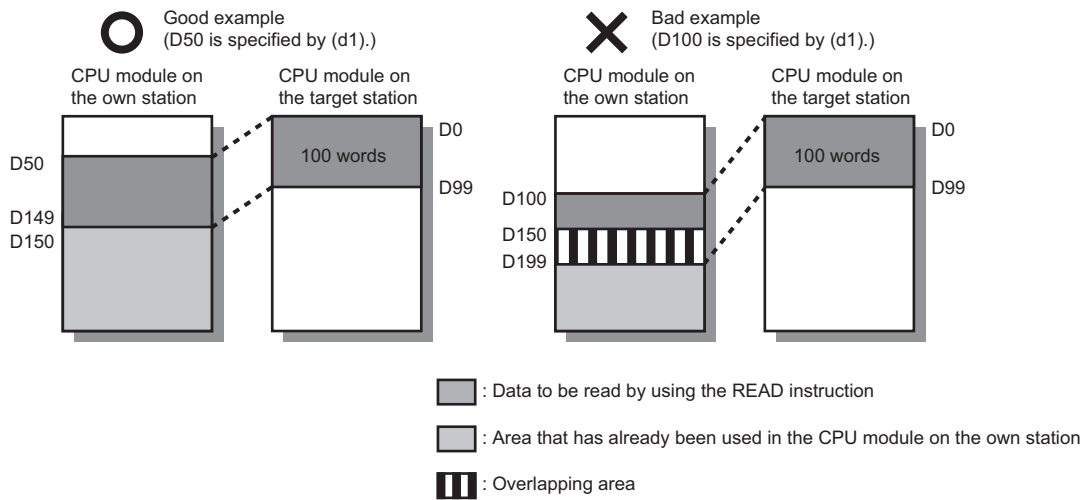

■Control data

Operand: (s1)									
Device	Item	Description	Setting range	Set by					
+0	Error completion type	<p>b15 ... b8 b7 ... b0</p> <table border="1" style="margin-left: 20px;"> <tr> <td style="width: 20px;">(3)</td> <td style="width: 20px;">0</td> <td style="width: 20px;">(2)</td> <td style="width: 20px;">(1)</td> <td style="width: 20px;">0</td> </tr> </table> <p>(1) Error completion type (bit 7) Specify whether to set data at completion with an error. <ul style="list-style-type: none"> • 0: Do not set data in (s1)+12 and later at completion with an error. • 1: Set data in (s1)+12 and later at completion with an error. (2) Arrival check time setting (bit 8) <ul style="list-style-type: none"> • 0: 1s units • 1: 100ms units (3) Target station address specification method (b15) <ul style="list-style-type: none"> • 0: Specify "network number" in (s1)+4, and specify "station number" in (s1)+5. • 1: Specify "IP address" in (s1)+4, 5 (Ethernet and CC-Link IE TSN). </p>	(3)	0	(2)	(1)	0	0000H 0080H 0100H 0180H 8000H 8080H 8100H 8180H	User
(3)	0	(2)	(1)	0					
+1	Completion status	<p>The completion status is stored upon completion of the instruction.</p> <ul style="list-style-type: none"> • 0: Normal • Other than 0: Error (error code) 	—	System					
+2	Own station channel	Specify the channel to be used by own station. (☞ Page 66 Range of available channels)	1 to 18	User					
+3	Target station CPU type	<p>Specify the CPU type of the target station.</p> <ul style="list-style-type: none"> • 0000H: Addressed to target station CPU (control CPU) • 03D0H: Addressed to control system CPU • 03D1H: Addressed to standby system CPU • 03D2H: Addressed to system A CPU • 03D3H: Addressed to system B CPU • 03E0H: Addressed to multiple CPU No.1 • 03E1H: Addressed to multiple CPU No.2 • 03E2H: Addressed to multiple CPU No.3 • 03E3H: Addressed to multiple CPU No.4 • 03FFH: Addressed to target station CPU (control CPU) 	0000H 03D0H to 03D3H 03E0H to 03E3H 03FFH	User					

Operand: (s1)				
Device	Item	Description	Setting range	Set by
+4	Target network number	<p>[CC-Link IE TSN, CC-Link IE Controller Network, CC-Link IE Field Network, or MELSECNET/H] Specify the network number (1 to 239) of the target station.</p> <p>[Ethernet or CC-Link IE TSN] ■When "0" is specified in bit 15 of (s1)+0 Specify the network number (1 to 239) of the target station. ■When "1" is specified in bit 15 of (s1)+0 Specify the IP address (third and fourth octets) of the target station.</p> <p>b15 ... b8 b7 ... b0 <input style="width: 100px; height: 15px;" type="text"/></p> <ul style="list-style-type: none"> • b8 to b15: 3rd octet • b0 to b7: 4th octet 	■(s1)+4 • Network number: 1 to 239 ■(s1)+5 • Station number: 1 to 120, 125, 126 ■(s1)+4, 5 • IP address: 00000001H to FFFFFFFEH	User
+5	Target station number	<p>[CC-Link IE Controller Network] Specify the station number (1 to 120) of the target station.</p> <p>[CC-Link IE Field Network] Specify the station number of the target station. • 125: Master station • 126: Master operating station • 1 to 120: Local station, intelligent device station, submaster station</p> <p>[Ethernet] ■When "0" is specified in bit 15 of (s1)+0 Specify the station number (1 to 120) of the target station. ■When "1" is specified in bit 15 of (s1)+0 Specify the IP address (first and second octets) of the target station.</p> <p>b15 ... b8 b7 ... b0 <input style="width: 100px; height: 15px;" type="text"/></p> <ul style="list-style-type: none"> • b8 to b15: 1st octet • b0 to b7: 2nd octet <p>[CC-Link IE TSN] ■When "0" is specified in bit 15 of (s1)+0 Specify the station number of the target station. • 1 to 120: Local station • 125: Master station ■When "1" is specified in bit 15 of (s1)+0 Specify the IP address (first and second octets) of the target station.</p> <p>b15 ... b8 b7 ... b0 <input style="width: 100px; height: 15px;" type="text"/></p> <ul style="list-style-type: none"> • b8 to b15: 1st octet • b0 to b7: 2nd octet <p>[MELSECNET/H] Specify the station number of the target station. • 1 to 64: Station number</p>		User
+6	Not used	—	—	—
+7	Number of resends	■Before instruction execution Specify the number of resends to be performed if the instruction is not completed within the monitoring time specified by (s1)+8. • 0 to 15 times ■At completion of instruction The number of resends performed (result) is stored. • 0 to 15 times	0 to 15	User/ system

Operand: (s1)																
Device	Item	Description	Setting range	Set by												
+8	Arrival monitoring time	[CC-Link IE TSN, CC-Link IE Controller Network, CC-Link IE Field Network, or MELSENET/H] Specify the monitoring time until completion of processing. If processing is not completed within the monitoring time, the request is resent by the number of resends specified in (s1)+7. <ul style="list-style-type: none"> ■When "0" is specified in bit 8 of (s1)+0 <ul style="list-style-type: none"> • 0: 10s • 1 to 32767: 1 to 32767s ■When "1" is specified in bit 8 of (s1)+0 <ul style="list-style-type: none"> • 0: 10s • 1 to 65535: 1 to 65535 × 100ms 	0 to 65535	User												
		[Ethernet] Specify the monitoring time until completion of processing. If processing is not completed within the monitoring time, the request is resent by the number of resends specified in (s1)+7. <ul style="list-style-type: none"> ■When "0" is specified in bit 8 of (s1)+0 Specify the TCP resend timer value or greater for the monitoring time till completion of processing. <ul style="list-style-type: none"> • 0 to (TCP resend timer value): The TCP resend timer value is assumed as the monitoring time. • (TCP resend timer value + 1) to 16383: (TCP resend timer value + 1) to 16383s ■When "1" is specified in bit 8 of (s1)+0 <ul style="list-style-type: none"> • 0: 10s • 1 to 65535: 1 to 65535 × 100ms 	0 to 65535	User												
+9	Read data length	Specify the number of words to be read. <ul style="list-style-type: none"> ■When reading data from RCP, QCPU, or LCP <ul style="list-style-type: none"> • Channels 1 to 8 are used: 1 to 960 (words) • Channels 9 and 10 are used: 1 to 8192 (words) ■When reading data from QnACPU <ul style="list-style-type: none"> • 1 to 480 (words) 	1 to 8192	User												
+10	Not used	—	—	—												
+11	Clock setting flag	The validity status (valid or invalid) of the data in (s1)+12 and later is stored. Note that the data in (s1)+12 and later is not cleared even when the instruction is completed successfully. <ul style="list-style-type: none"> • 0: Invalid • 1: Valid 	—	System												
+12	Clock data (Set only in an abnormal state)	Upper 8 bits: Month (01H to 12H) Lower 8 bits: Year (00H to 99H: Upper two digits of the year)	—	System												
+13		Upper 8 bits: Hour (00H to 23H) Lower 8 bits: Day (01H to 31H)	—	System												
+14		Upper 8 bits: Second (00H to 59H) Lower 8 bits: Minute (00H to 59H)	—	System												
+15		Upper 8 bits: Year (00H to 99H: Upper two digits of the year) Lower 8 bits: Day of the week (00H (Sun.) to 06H (Sat.))	—	System												
+16	Error detection network number	<ul style="list-style-type: none"> ■When "0" is specified in bit 15 of (s1)+0 The network number of the station in which an error was detected is stored. (No information is stored if an error is detected in the own station.) <ul style="list-style-type: none"> • 1 to 239 (Network number) ■When "1" is specified in bit 15 of (s1)+0 (Ethernet and CC-Link IE TSN) The IP address (third and fourth octets) in which an error is detected is stored. <div style="border: 1px solid black; padding: 5px; margin: 5px 0;"> <table style="width: 100%; border-collapse: collapse;"> <tr> <td style="text-align: right; padding-right: 10px;">b15</td> <td style="text-align: center;">...</td> <td style="text-align: right; padding-right: 10px;">b8</td> <td style="text-align: center;">b7</td> <td style="text-align: center;">...</td> <td style="text-align: left; padding-left: 10px;">b0</td> </tr> <tr> <td colspan="6" style="border: 1px solid black; height: 15px;"></td> </tr> </table> </div> <ul style="list-style-type: none"> • b8 to b15: 3rd octet • b0 to b7: 4th octet 	b15	...	b8	b7	...	b0							—	System
b15	...	b8	b7	...	b0											

Operand: (s1)						
Device	Item	Description	Setting range	Set by		
+17	Error-detected station number	<p>■When "0" is specified in bit 15 of (s1)+0 The station number of the station where an error was detected is stored. (No information is stored if an error is detected in the own station.) [Ethernet or CC-Link IE Controller Network]</p> <ul style="list-style-type: none"> • 1 to 120: Station number <p>[CC-Link IE Field Network]</p> <ul style="list-style-type: none"> • 125: Master station • 1 to 120: Local station, intelligent device station, submaster station <p>[CC-Link IE TSN]</p> <ul style="list-style-type: none"> • 125: Master station • 1 to 120: Slave station <p>[MELSECNET/H]</p> <ul style="list-style-type: none"> • 1 to 64: Station number <p>■When "1" is specified in bit 15 of (s1)+0 (Ethernet and CC-Link IE TSN) The IP address (first and second octets) of the station where an error was detected is stored.</p> <div style="border: 1px solid black; padding: 5px; margin: 10px 0;"> <p>b15 ... b8 b7 ... b0</p> <table style="width: 100%; border-collapse: collapse;"> <tr> <td style="border: 1px solid black; width: 50%; height: 20px;"></td> <td style="border: 1px solid black; width: 50%; height: 20px;"></td> </tr> </table> </div> <ul style="list-style-type: none"> • b8 to b15: 1st octet • b0 to b7: 2nd octet 			—	System

Point

- The continuous area (a maximum of 8192 words) specified by (s1)+9 is required in the read data storage device (d1).
- The number of resends (s1)+7 must be set every time the instruction is executed.

Processing details

- These instructions read the data from the specified word device in the target station specified by the target network number and target station number of the control data or the target station specified by the IP address. Upon completion of reading the device data, the completion device specified by (d2) turns on.
- For the target stations that can be specified, refer to the following.

☞ Page 65 Target networks and target station types

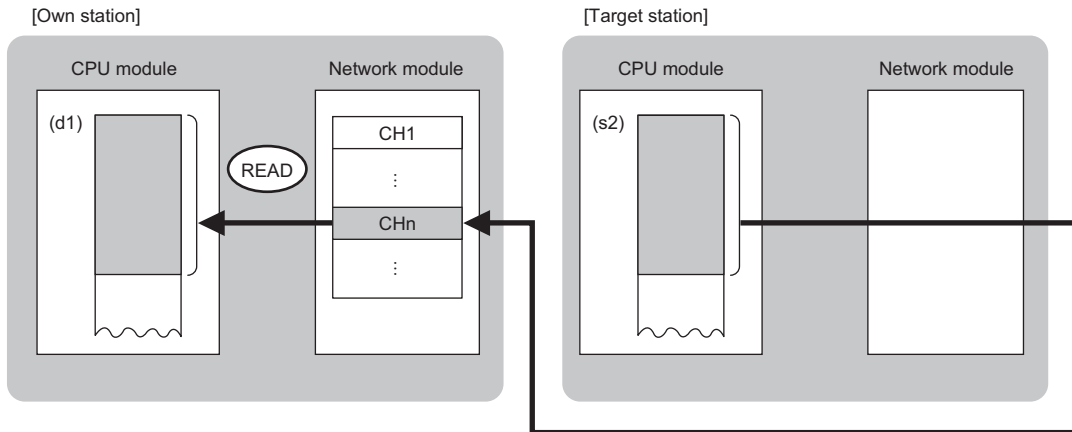

CH: Channel

- When "network number" and "station number" are specified ("0" is specified in bit 15 of (s1)+0) by the target station address specification method, device data can be read also from stations connected to networks other than the stations connected to the own station network. (If "IP address" is specified ("1" is specified in bit 15 of (s1)+0), device data cannot be read from stations connected via a relay station.)
- When executing multiple link dedicated instructions concurrently, be careful not to overlap the channels of the link dedicated instructions. Multiple link dedicated instructions specifying the same channel cannot be used concurrently.
- The execution status and the completion status of the READ instruction can be checked with the completion device (d2) and the completion status indication device (d2)+1.

- Completion device (d2)

This device turns on during END processing of the scan where the READ instruction completes, and turns off during the next END processing.

- Completion status indication device (d2)+1

This device turns on or off depending on the completion status of the READ instruction.

When completed successfully: The device remains off.

When completed with an error: The device turns on during END processing of the scan where the READ instruction completes, and turns off during the next END processing.

• The following figure shows the execution timing of the READ instruction.

• When completed successfully

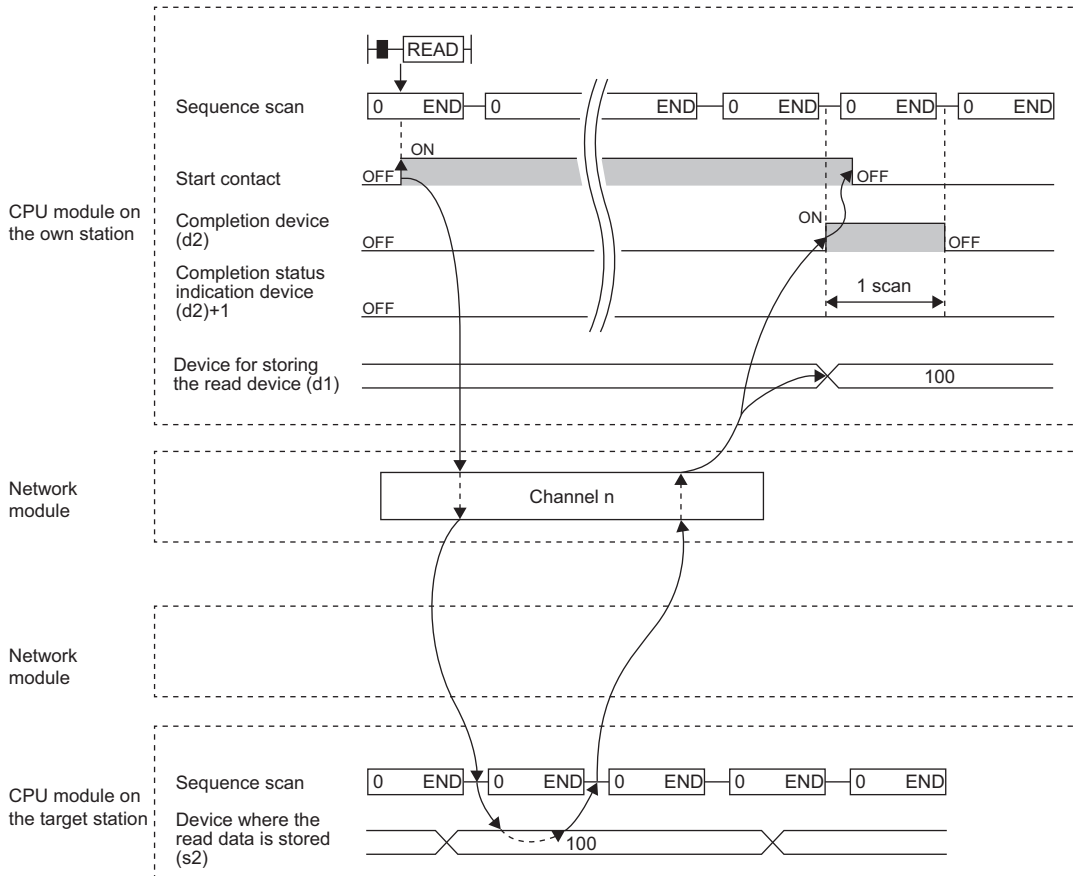



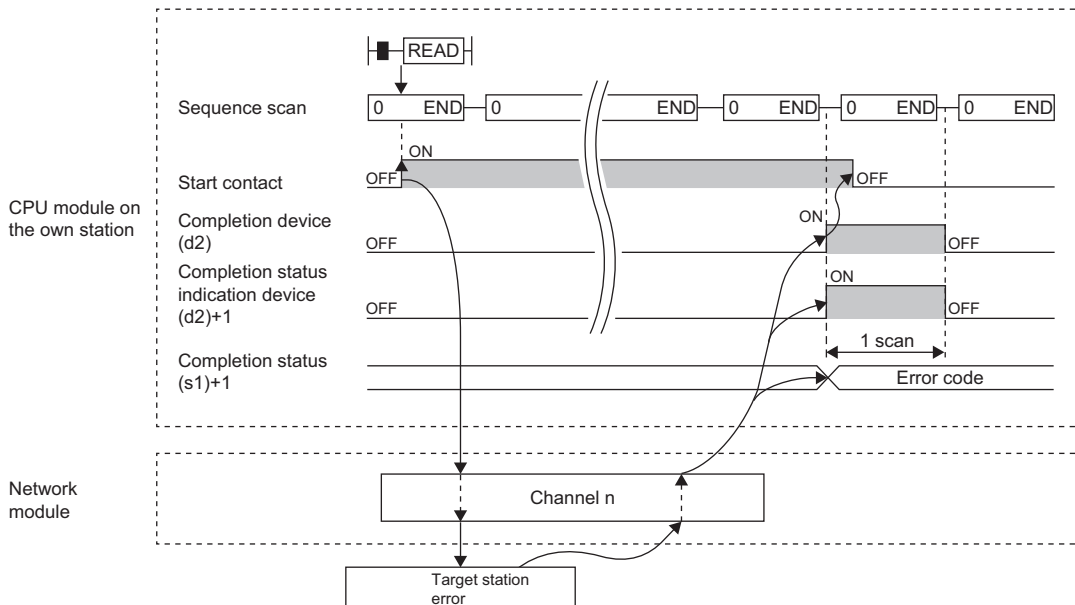







• When completed with an error



• Read processing is performed only once on the rising edge when the read command turns on.

Operation error

Error code ((s1)+1)	Description
4000H to 4FFFH	 MELSEC iQ-R CPU Module User's Manual (Application)
6F00H to 6FFFH	 MELSEC iQ-R CPU Module User's Manual (Application)
C000H to CFBFH	 MELSEC iQ-R Ethernet User's Manual (Application)  MELSEC iQ-R CC-Link IE TSN User's Manual (Application)
CFC0H to CFFFH	 MELSEC iQ-R CPU Module User's Manual (Application)  MELSEC iQ-R CC-Link IE TSN User's Manual (Application)
D000H to DFFFH	 MELSEC iQ-R CC-Link IE Field Network User's Manual (Application)  MELSEC iQ-R CC-Link IE TSN User's Manual (Application)
E000H to EFFFH	 MELSEC iQ-R CC-Link IE Controller Network User's Manual (Application)
F000H to FFFFH	 MELSEC iQ-R MELSECNET/H Network Module User's Manual (Application)

Reading data from the programmable controller on another station (with notification)

JP.SREAD, GP.SREAD

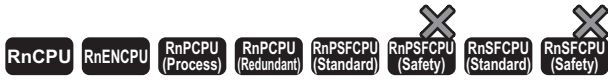

These instructions read data from a device in the programmable controller of another station. (in units of words)
 After the data reading is completed by the SREAD instruction, the device of another station is turned on. The other station can recognize that data has been read by the SREAD instruction.

Ladder	ST
	<pre>ENO:=JP_SREAD(EN,J,s1,s2,d1,d2,d3); ENO:=GP_SREAD(EN,U,s1,s2,d1,d2,d3);</pre>

FBD/LD

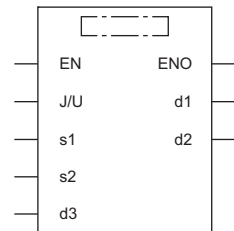

Execution condition

Instruction	Execution condition
JP.SREAD GP.SREAD	

Setting data

Description, range, data type

Operand	Description	Range	Data type	Data type (label)	
(J/U)	JP.SREAD	(J): Own station network number	1 to 239	16-bit unsigned binary	ANY16
	GP.SREAD	(U): Start I/O number (first three digits in four-digit hexadecimal representation) of own station or own node	00H to FEH	16-bit unsigned binary	ANY16
(s1)	Own station start device where control data is stored	Refer to the control data.	Device name	ANY16 ^{*1}	
(s2)	Target station start device where the data to be read is stored	—	String ^{*2}	ANYSTRING_SINGLE ^{*2}	
(d1)	Own station start device for storing the read data	—	Device name	ANY16 ^{*1}	
(d2)	Device of the own station, which turns on for one scan upon completion of the instruction. When the instruction completes with an error, (d2)+1 also turns on.	—	Bit	ANYBIT_ARRAY (Number of elements: 2)	
(d3)	Device of the target station, which turns on for one scan upon completion of the instruction. (The target station can recognize that data has been read from another station.)	—	String ^{*2}	ANYSTRING_SINGLE ^{*2}	
EN	Execution condition	—	Bit	BOOL	
ENO	Execution result	—	Bit	BOOL	

*1 When specifying setting data by using a label, define an array to secure enough operation area and specify an element of the array label.

*2 For the specifications of the string data to be specified, refer to the following.

Page 70 Specifications of character string data specified by link dedicated instructions

■Applicable devices

Operand		Bit		Word			Double word		Indirect specification	Constant			Others	
		X, Y, M, L, SM, F, B, SB, FX, FY	J□□	T, ST, C, D, W, SD, SW, FD, R, ZR, RD	U□\G□, J□\□, U3E□\□(H)G□	Z	LT, LST, LC	LZ		K, H, E, \$	J, U			
(J/U)	JP.SREAD	—	—	—	—	—	—	—	—	—	—	—	○	—
	GP.SREAD	—	—	○	—	—	—	—	○	○	—	—	—	○
(s1)		—	—	○*2	—	—	—	—	○	—	—	—	—	—
(s2)		—	—	—	—	—	—	—	—	—	—	○	—	—
(d1)		—	—	○*2	—	—	—	—	○	—	—	—	—	—
(d2)		○*1	—	○*3	—	—	—	—	—	—	—	—	—	—
(d3)		—	—	—	—	—	—	—	—	—	—	○	—	—

*1 FX and FY cannot be used.

*2 FD cannot be used.

*3 T, ST, C, and FD cannot be used.

Point

- The SREAD instruction cannot be executed when the target station is ACPU.
- Specify the own station start device (d1) for storing the data that has been read, by considering the range in which the data that has been read can be stored.

(Example: When areas D150 and after in the own station CPU module are already in use)

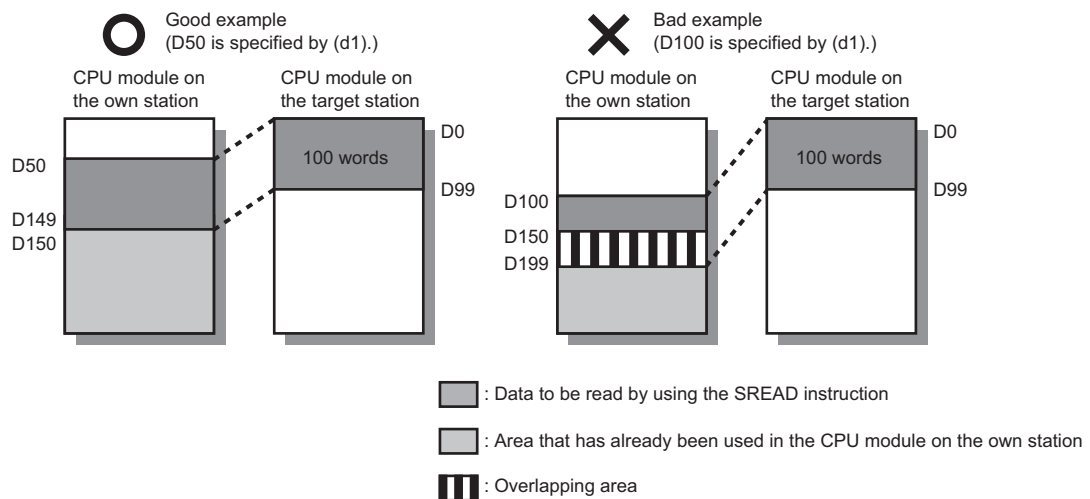

- When the target station for which the SREAD instruction is executed is the Basic model QCPU, the read notification device for the target station specified by argument (d3) is ignored. The operations of the SREAD instruction are the same as those of the READ instruction.
- The SREAD instruction can be programmed by omitting argument (d3). However, the operations are the same as those of the READ instruction. The operations of the SREAD instruction can be selected according to whether (d3) is omitted or not.

■Control data

Operand: (s1)									
Device	Item	Description	Setting range	Set by					
+0	Error completion type	<p>b15 ... b8 b7 ... b0</p> <table border="1" style="margin-left: 20px;"> <tr> <td style="width: 20px;">(3)</td> <td style="width: 20px;">0</td> <td style="width: 20px;">(2)</td> <td style="width: 20px;">(1)</td> <td style="width: 20px;">0</td> </tr> </table> <p>(1) Error completion type (bit 7) Specify whether to set data at completion with an error. • 0: Do not set data in (s1)+12 and later at completion with an error. • 1: Set data in (s1)+12 and later at completion with an error.</p> <p>(2) Arrival check time setting (bit 8) • 0: 1s units • 1: 100ms units</p> <p>(3) Target station address specification method (b15) • 0: Specify "network number" in (s1)+4, and specify "station number" in (s1)+5. • 1: Specify "IP address" in (s1)+4, 5 (Ethernet and CC-Link IE TSN).</p>	(3)	0	(2)	(1)	0	0000H 0080H 0100H 0180H 8000H 8080H 8100H 8180H	User
(3)	0	(2)	(1)	0					
+1	Completion status	<p>The completion status is stored upon completion of the instruction.</p> <ul style="list-style-type: none"> • 0: Normal • Other than 0: Error (error code) 	—	System					
+2	Own station channel	Specify the channel to be used by own station. (☞ Page 66 Range of available channels)	1 to 18	User					
+3	Target station CPU type	<p>Specify the CPU type of the target station.</p> <ul style="list-style-type: none"> • 0000H: Addressed to target station CPU (control CPU) • 03D0H: Addressed to control system CPU • 03D1H: Addressed to standby system CPU • 03D2H: Addressed to system A CPU • 03D3H: Addressed to system B CPU • 03E0H: Addressed to multiple CPU No.1 • 03E1H: Addressed to multiple CPU No.2 • 03E2H: Addressed to multiple CPU No.3 • 03E3H: Addressed to multiple CPU No.4 • 03FFH: Addressed to target station CPU (control CPU) 	0000H 03D0H to 03D3H 03E0H to 03E3H 03FFH	User					

Operand: (s1)							
Device	Item	Description	Setting range	Set by			
+4	Target network number	<p>[CC-Link IE Controller Network, CC-Link IE Field Network, or MELSECNET/H] Specify the network number (1 to 239) of the target station.</p> <p>[Ethernet or CC-Link IE TSN] ■When "0" is specified in bit 15 of (s1)+0 Specify the network number (1 to 239) of the target station. ■When "1" is specified in bit 15 of (s1)+0 Specify the IP address (third and fourth octets) of the target station.</p> <p>b15 ... b8 b7 ... b0</p> <table border="1" style="width: 100%; border-collapse: collapse;"> <tr> <td style="width: 50%; height: 15px;"></td> <td style="width: 50%; height: 15px;"></td> </tr> </table> <ul style="list-style-type: none"> • b8 to b15: 3rd octet • b0 to b7: 4th octet 			■(s1)+4 • Network number: 1 to 239 ■(s1)+5 • Station number: 1 to 120, 125, 126 ■(s1)+4, 5 • IP address: 0000001H to FFFFFFFEH	User	
+5	Target station number	<p>[CC-Link IE Controller Network] Specify the station number (1 to 120) of the target station.</p> <p>[CC-Link IE Field Network] Specify the station number of the target station.</p> <ul style="list-style-type: none"> • 125: Master station • 126: Master operating station • 1 to 120: Local station, intelligent device station, submaster station <p>[Ethernet] ■When "0" is specified in bit 15 of (s1)+0 Specify the station number (1 to 120) of the target station. ■When "1" is specified in bit 15 of (s1)+0 Specify the IP address (first and second octets) of the target station.</p> <p>b15 ... b8 b7 ... b0</p> <table border="1" style="width: 100%; border-collapse: collapse;"> <tr> <td style="width: 50%; height: 15px;"></td> <td style="width: 50%; height: 15px;"></td> </tr> </table> <ul style="list-style-type: none"> • b8 to b15: 1st octet • b0 to b7: 2nd octet <p>[CC-Link IE TSN] ■When "0" is specified in bit 15 of (s1)+0 Specify the station number of the target station.</p> <ul style="list-style-type: none"> • 1 to 120: Local station • 125: Master station <p>■When "1" is specified in bit 15 of (s1)+0 Specify the IP address (first and second octets) of the target station.</p> <p>b15 ... b8 b7 ... b0</p> <table border="1" style="width: 100%; border-collapse: collapse;"> <tr> <td style="width: 50%; height: 15px;"></td> <td style="width: 50%; height: 15px;"></td> </tr> </table> <ul style="list-style-type: none"> • b8 to b15: 1st octet • b0 to b7: 2nd octet <p>[MELSECNET/H] Specify the station number of the target station.</p> <ul style="list-style-type: none"> • 1 to 64: Station number 					
+6	Not used	—	—	—			
+7	Number of resends	<p>■Before instruction execution Specify the number of resends to be performed if the instruction is not completed within the monitoring time specified by (s1)+8.</p> <ul style="list-style-type: none"> • 0 to 15 times <p>■At completion of instruction The number of resends performed (result) is stored.</p> <ul style="list-style-type: none"> • 0 to 15 times 	0 to 15	User/ system			

Operand: (s1)						
Device	Item	Description	Setting range	Set by		
+8	Arrival monitoring time	[CC-Link IE TSN, CC-Link IE Controller Network, CC-Link IE Field Network, or MELSECNET/H] Specify the monitoring time until completion of processing. If processing is not completed within the monitoring time, the request is resent by the number of resends specified in (s1)+7. <ul style="list-style-type: none"> ■When "0" is specified in bit 8 of (s1)+0 <ul style="list-style-type: none"> • 0: 10s • 1 to 32767: 1 to 32767s ■When "1" is specified in bit 8 of (s1)+0 <ul style="list-style-type: none"> • 0: 10s • 1 to 65535: 1 to 65535 × 100ms 	0 to 65535	User		
		[Ethernet] Specify the monitoring time until completion of processing. If processing is not completed within the monitoring time, the request is resent by the number of resends specified in (s1)+7. <ul style="list-style-type: none"> ■When "0" is specified in bit 8 of (s1)+0 Specify the TCP resend timer value or greater for the monitoring time till completion of processing. <ul style="list-style-type: none"> • 0 to (TCP resend timer value): The TCP resend timer value is assumed as the monitoring time. • (TCP resend timer value + 1) to 16383: (TCP resend timer value + 1) to 16383s ■When "1" is specified in bit 8 of (s1)+0 <ul style="list-style-type: none"> • 0: 10s • 1 to 65535: 1 to 65535 × 100ms 	0 to 65535	User		
+9	Read data length	Specify the number of words to be read. <ul style="list-style-type: none"> ■When reading data from RCP, QCPU, or LCP <ul style="list-style-type: none"> • Channels 1 to 8 are used: 1 to 960 (words) • Channels 9 and 10 are used: 1 to 8192 (words) ■When reading data from QnACPU <ul style="list-style-type: none"> • 1 to 480 (words) 	1 to 8192	User		
+10	Not used	—	—	—		
+11	Clock setting flag	The validity status (valid or invalid) of the data in (s1)+12 and later is stored. Note that the data in (s1)+12 and later is not cleared even when the instruction is completed successfully. <ul style="list-style-type: none"> • 0: Invalid • 1: Valid 	—	System		
+12	Clock data (Set only in an abnormal state)	Upper 8 bits: Month (01H to 12H) Lower 8 bits: Year (00H to 99H: Upper two digits of the year)	—	System		
+13		Upper 8 bits: Hour (00H to 23H) Lower 8 bits: Day (01H to 31H)	—	System		
+14		Upper 8 bits: Second (00H to 59H) Lower 8 bits: Minute (00H to 59H)	—	System		
+15		Upper 8 bits: Year (00H to 99H: Upper two digits of the year) Lower 8 bits: Day of the week (00H (Sun.) to 06H (Sat.))	—	System		
+16	Error detection network number	<ul style="list-style-type: none"> ■When "0" is specified in bit 15 of (s1)+0 The network number of the station in which an error was detected is stored. (No information is stored if an error is detected in the own station.) <ul style="list-style-type: none"> • 1 to 239 (Network number) ■When "1" is specified in bit 15 of (s1)+0 (Ethernet and CC-Link IE TSN) The IP address (third and fourth octets) in which an error is detected is stored. <div style="text-align: center;"> b15 ... b8 b7 ... b0 <table border="1" style="margin: auto;"> <tr> <td style="width: 100px; height: 15px;"></td> <td style="width: 100px; height: 15px;"></td> </tr> </table> </div> <ul style="list-style-type: none"> • b8 to b15: 3rd octet • b0 to b7: 4th octet 			—	System

Operand: (s1)						
Device	Item	Description	Setting range	Set by		
+17	Error-detected station number	<p>■When "0" is specified in bit 15 of (s1)+0 The station number of the station where an error was detected is stored. (No information is stored if an error is detected in the own station.) [Ethernet or CC-Link IE Controller Network]</p> <ul style="list-style-type: none"> • 1 to 120: Station number <p>[CC-Link IE Field Network]</p> <ul style="list-style-type: none"> • 125: Master station • 1 to 120: Local station, intelligent device station, submaster station <p>[CC-Link IE TSN]</p> <ul style="list-style-type: none"> • 125: Master station • 1 to 120: Slave station <p>[MELSECNET/H]</p> <ul style="list-style-type: none"> • 1 to 64: Station number <p>■When "1" is specified in bit 15 of (s1)+0 (Ethernet and CC-Link IE TSN) The IP address (first and second octets) of the station where an error was detected is stored.</p> <p>b15 ... b8 b7 ... b0</p> <table border="1" style="width: 100%; border-collapse: collapse;"> <tr> <td style="width: 50%; height: 15px;"></td> <td style="width: 50%; height: 15px;"></td> </tr> </table> <ul style="list-style-type: none"> • b8 to b15: 1st octet • b0 to b7: 2nd octet 			—	System

Point

- The continuous area (a maximum of 8192 words) specified by (s1)+9 is required in the read data storage device (d1).
- The number of resends (s1)+7 must be set every time the instruction is executed.

Processing details

- These instructions read the data from the specified word device in the target station specified by the target network number and target station number of the control data or the target station specified by the IP address. Upon completion of reading the device data, the completion device specified by (d2) turns on. In another station, upon completion of sending the device data specified by (s2), the device specified by (d3) turns on.
- For the target stations that can be specified, refer to the following.

☞ Page 65 Target networks and target station types

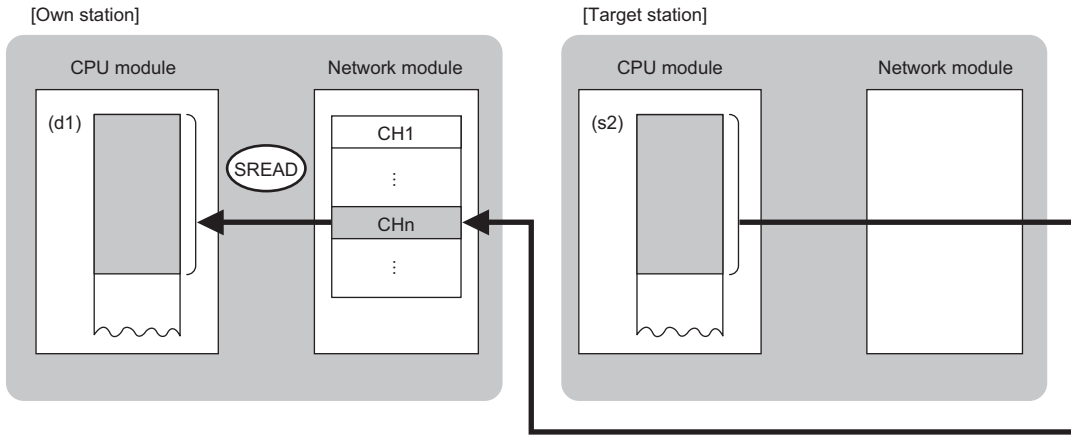

CH: Channel

- When "network number" and "station number" are specified ("0" is specified in bit 15 of (s1)+0) by the target station address specification method, device data can be read also from stations connected to networks other than the stations connected to the own station network. (If "IP address" is specified ("1" is specified in bit 15 of (s1)+0), device data cannot be read from stations connected via a relay station.)
- When executing multiple link dedicated instructions concurrently, be careful not to overlap the channels of the link dedicated instructions. Multiple link dedicated instructions specifying the same channel cannot be used concurrently.
- The execution status and the completion status of the SREAD instruction can be checked with the send/receive instruction flag that corresponds the channel used, the completion device (d2) specified in setting data, and the completion status indication device (d2)+1.
- Completion device (d2)

This device turns on during END processing of the scan where the SREAD instruction completes, and turns off during the next END processing.

- Completion status indication device (d2)+1

This device turns on or off depending on the completion status of the SREAD instruction.

When completed successfully: The device remains off.

When completed with an error: The device turns on during END processing of the scan where the SREAD instruction completes, and turns off during the next END processing.

• The following figure shows the execution timing of the SREAD instruction.

• When completed successfully

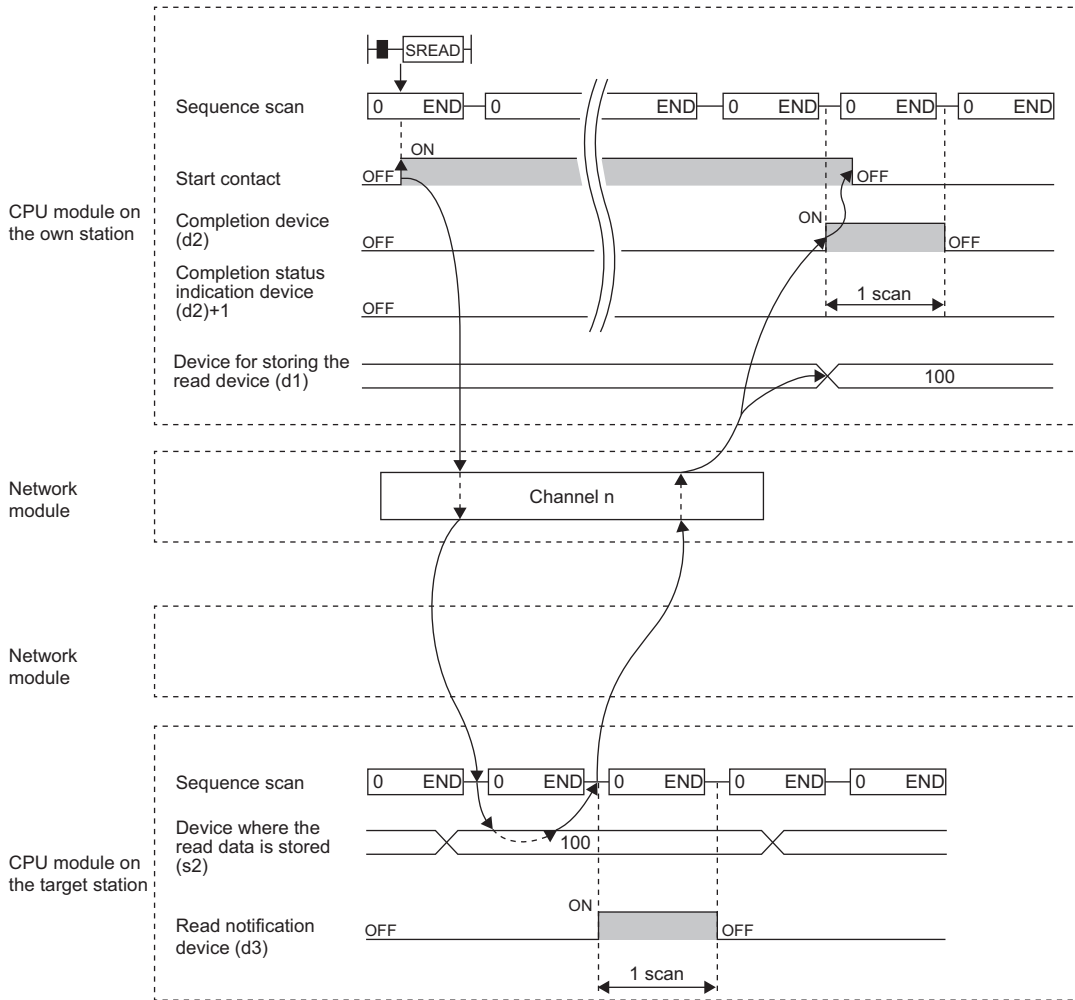



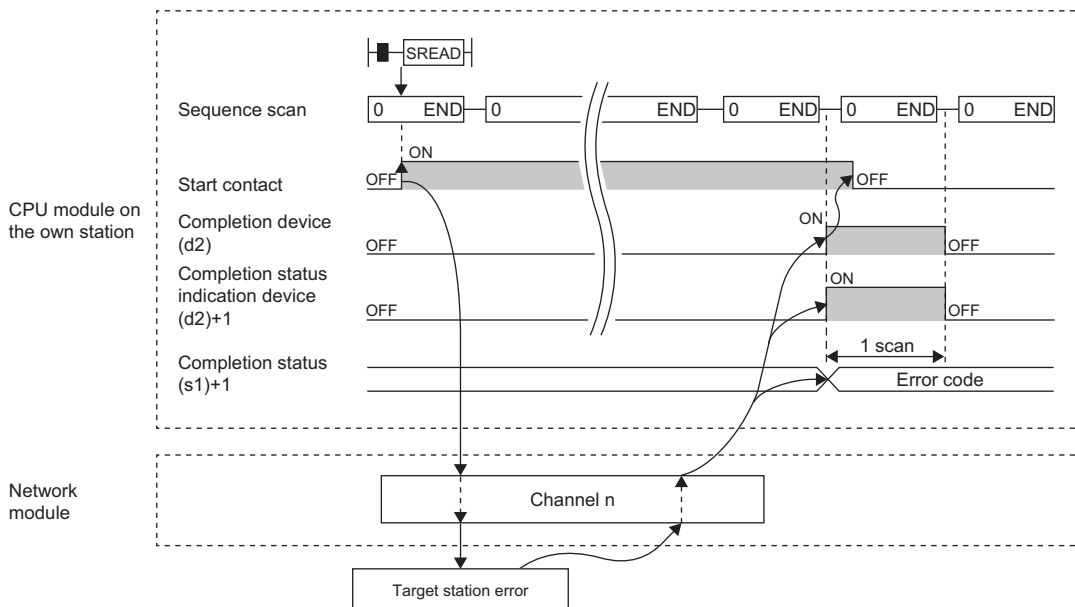







• When completed with an error



• Read processing is performed only once on the rising edge when the read command turns on.

Operation error

Error code ((s1)+1)	Description
4000H to 4FFFH	 MELSEC iQ-R CPU Module User's Manual (Application)
6F00H to 6FFFH	 MELSEC iQ-R CPU Module User's Manual (Application)
C000H to CFBFH	 MELSEC iQ-R Ethernet User's Manual (Application)  MELSEC iQ-R CC-Link IE TSN User's Manual (Application)
CFC0H to CFFFH	 MELSEC iQ-R CPU Module User's Manual (Application)  MELSEC iQ-R CC-Link IE TSN User's Manual (Application)
D000H to DFFFH	 MELSEC iQ-R CC-Link IE Field Network User's Manual (Application)  MELSEC iQ-R CC-Link IE TSN User's Manual (Application)
E000H to EFFFH	 MELSEC iQ-R CC-Link IE Controller Network User's Manual (Application)
F000H to FFFFH	 MELSEC iQ-R MELSECNET/H Network Module User's Manual (Application)

Writing data to the programmable controller on another station

JP.WRITE, GP.WRITE



These instructions write data to a device in the programmable controller of another station (in units of words).

Ladder	ST
<p>Diagram showing a box with inputs (J/U), (s1), (s2), (d1), and (d2).</p>	<pre>ENO:=JP_WRITE(EN,J,s1,s2,d1,d2); ENO:=GP_WRITE(EN,U,s1,s2,d1,d2);</pre>

FBD/LD

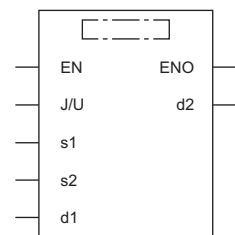

Execution condition

Instruction	Execution condition
JP.WRITE GP.WRITE	

Setting data

Description, range, data type

Operand	Description	Range	Data type	Data type (label)
(J/U)	JP.WRITE (J): Own station network number GP.WRITE (U): Start I/O number (first three digits in four-digit hexadecimal representation) of own station or own node	1 to 239 00H to FEH	16-bit unsigned binary 16-bit unsigned binary	ANY16 ANY16
(s1)	Own station start device where control data is stored	Refer to the control data.	Device name	ANY16 ^{*1}
(s2)	Own station start device where data to be written is stored	—	Device name	ANY16 ^{*1}
(d1)	Target station start device where data is to be written	—	String ^{*2}	ANYSTRING_SINGLE ^{*2}
(d2)	Device of the own station, which turns on for one scan upon completion of the instruction. When the instruction completes with an error, (d2)+1 also turns on.	—	Bit	ANYBIT_ARRAY (Number of elements: 2)
EN	Execution condition	—	Bit	BOOL
ENO	Execution result	—	Bit	BOOL

*1 When specifying setting data by using a label, define an array to secure enough operation area and specify an element of the array label.

*2 For the specifications of the string data to be specified, refer to the following.

Page 70 Specifications of character string data specified by link dedicated instructions

■Applicable devices

Operand		Bit		Word			Double word		Indirect specification	Constant			Others	
		X, Y, M, L, SM, F, B, SB, FX, FY	J□□	T, ST, C, D, W, SD, SW, FD, R, ZR, RD	U□\G□, J□\□, U3E□\□(H)G□	Z	LT, LST, LC	LZ		K, H, E, \$	J, U			
(J/U)	JP.WRITE	—	—	—	—	—	—	—	—	—	—	—	○	—
	GP.WRITE	—	—	○	—	—	—	—	○	○	—	—	—	○
(s1)		—	—	○*2	—	—	—	—	○	—	—	—	—	—
(s2)		—	—	○*2	—	—	—	—	○	—	—	—	—	—
(d1)		—	—	—	—	—	—	—	—	—	—	○	—	—
(d2)		○*1	—	○*3	—	—	—	—	—	—	—	—	—	—

*1 FX and FY cannot be used.

*2 FD cannot be used.

*3 T, ST, C, and FD cannot be used.

Point 

- The WRITE instruction cannot be executed when the target station is ACPU.
- Specify the target station start device (d1) where data is to be written by considering the range in which the data that has been written can be stored.

(Example: When areas D150 and after in the target station CPU module are already in use)

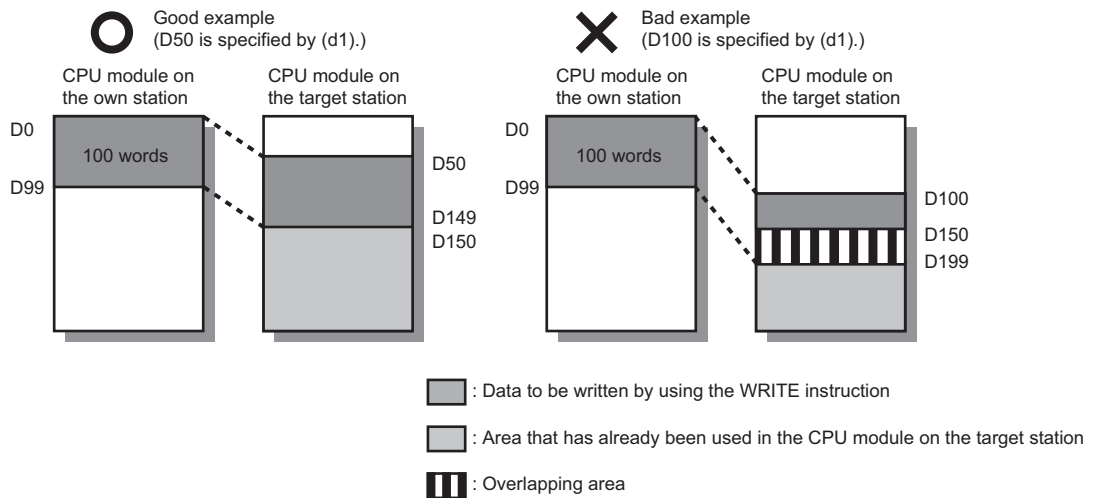

Control data

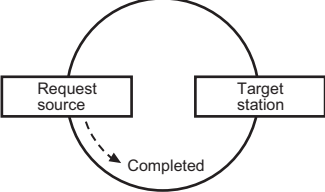
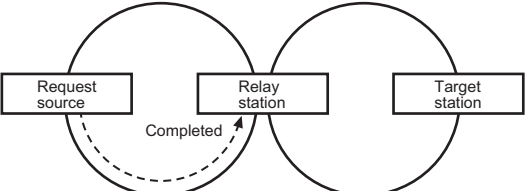
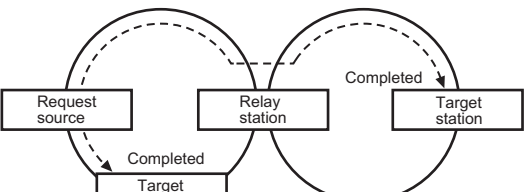
Operand: (s1)				
Device	Item	Description	Setting range	Set by
+0	Execution/error completion type	<p>b15 ... b8 b7 ... b0</p> <p>(4) 0 (3)(2) 0 (1)</p> <p>(1) Execution type (bit 0)</p> <ul style="list-style-type: none"> • 0: No arrival acknowledgment <p>When the target station is in the own network: Completed when data has been sent from the own station.</p>  <p>When the target station is in another network: Completed when data has arrived the relay station of the own network.</p>  <ul style="list-style-type: none"> • 1: Arrival acknowledgment used <p>Sending data is completed when the data is written to the target station.</p>  <p>(2) Error completion type (bit 7)</p> <p>Specify whether to set clock data at completion with an error.</p> <ul style="list-style-type: none"> • 0: Do not set data in (s1)+11 and later at completion with an error. • 1: Set data in (s1)+11 and later at completion with an error. <p>(3) Arrival check time setting (bit 8)</p> <ul style="list-style-type: none"> • 0: 1s units • 1: 100ms units <p>(4) Target station address specification method (b15)</p> <ul style="list-style-type: none"> • 0: Specify "network number" in (s1)+4, and specify "station number" in (s1)+5. • 1: Specify "IP address" in (s1)+4, 5 (Ethernet and CC-Link IE TSN). 	0000H 0001H 0080H 0081H 0100H 0101H 0180H 0181H 8000H 8001H 8080H 8081H 8100H 8101H 8180H 8181H	User
+1	Completion status	<p>The completion status is stored upon completion of the instruction.</p> <ul style="list-style-type: none"> • 0: Normal • Other than 0: Error (error code) 	—	System
+2	Own station channel	Specify the channel to be used by own station. (☞ Page 66 Range of available channels)	1 to 18	User
+3	Target station CPU type	<p>Specify the CPU type of the target station.</p> <ul style="list-style-type: none"> • 0000H: Addressed to target station CPU (control CPU) • 03D0H: Addressed to control system CPU • 03D1H: Addressed to standby system CPU • 03D2H: Addressed to system A CPU • 03D3H: Addressed to system B CPU • 03E0H: Addressed to multiple CPU No.1 • 03E1H: Addressed to multiple CPU No.2 • 03E2H: Addressed to multiple CPU No.3 • 03E3H: Addressed to multiple CPU No.4 • 03FFH: Addressed to target station CPU (control CPU) 	0000H 03D0H to 03D3H 03E0H to 03E3H 03FFH	User

Operand: (s1)						
Device	Item	Description	Setting range	Set by		
+4	Target network number	<p>[CC-Link IE Controller Network, CC-Link IE Field Network, or MELSECNET/H] Specify the network number (1 to 239) of the target station.</p> <p>[Ethernet or CC-Link IE TSN] ■When "0" is specified in bit 15 of (s1)+0 Specify the network number (1 to 239) of the target station. ■When "1" is specified in bit 15 of (s1)+0 Specify the IP address (third and fourth octets) of the target station.</p> <p>b15 ... b8 b7 ... b0</p> <table border="1" style="width: 100%; border-collapse: collapse;"> <tr> <td style="width: 50%; height: 15px;"></td> <td style="width: 50%; height: 15px;"></td> </tr> </table> <ul style="list-style-type: none"> • b8 to b15: 3rd octet • b0 to b7: 4th octet 			<ul style="list-style-type: none"> ■(s1)+4 • Network number: 1 to 239 ■(s1)+5 • Station number: 1 to 120, 125, 126 • Group number: 0081H to 00A0H • All-station specification: 00FFH 	User
+5	Target station number	<p>[CC-Link IE Controller Network] Specify the station number of the target station.</p> <p>(1) Station number specification</p> <ul style="list-style-type: none"> • 1 to 120: Station number <p>(2) Group number specification</p> <ul style="list-style-type: none"> • 0081H to 00A0H: All stations with group numbers 0001H to 0020H (Can be set when the execution type specified by (s1) is "0: No arrival acknowledgment") <p>(3) All-station specification</p> <ul style="list-style-type: none"> • 00FFH: All stations of target network number (broadcast (excluding the own station)) (Can be set when the execution type specified by (s1) is "0: No arrival acknowledgment") <p>[CC-Link IE Field Network] Specify the station number of the target station.</p> <p>(1) Station number specification</p> <ul style="list-style-type: none"> • 125: Master station • 126: Master operating station • 1 to 120: Local station, intelligent device station, submaster station <p>(2) All-station specification</p> <ul style="list-style-type: none"> • 00FFH: All stations of target network number (broadcast (excluding the own station)) (Can be set when the execution type specified by (s1) is "0: No arrival acknowledgment") <p>[Ethernet] ■When "0" is specified in bit 15 of (s1)+0 Specify the station number of the target station.</p> <p>(1) Station number specification</p> <ul style="list-style-type: none"> • 1 to 120: Station number <p>(2) Group number specification</p> <ul style="list-style-type: none"> • 0081H to 00A0H: All stations with group numbers 0001H to 0020H (Can be set when the execution type specified by (s1) is "0: No arrival acknowledgment") <p>(3) All-station specification</p> <ul style="list-style-type: none"> • 00FFH: All stations of target network number (broadcast (excluding the own station)) (Can be set when the execution type specified by (s1) is "0: No arrival acknowledgment") <p>■When "1" is specified in bit 15 of (s1)+0 Specify the IP address (first and second octets) of the target station.</p> <p>b15 ... b8 b7 ... b0</p> <table border="1" style="width: 100%; border-collapse: collapse;"> <tr> <td style="width: 50%; height: 15px;"></td> <td style="width: 50%; height: 15px;"></td> </tr> </table> <ul style="list-style-type: none"> • b8 to b15: 1st octet • b0 to b7: 2nd octet 			<ul style="list-style-type: none"> ■(s1)+4, 5 • IP address: 00000001H to FFFFFFFEH 	User

Operand: (s1)						
Device	Item	Description	Setting range	Set by		
+5	Target station number	<p>[CC-Link IE TSN]</p> <p>■When "0" is specified in bit 15 of (s1)+0 Specify the station number of the target station.</p> <p>(1) Station number specification</p> <ul style="list-style-type: none"> • 1 to 120: Local station • 125: Master station <p>(2) Group number specification</p> <ul style="list-style-type: none"> • 0081H to 00A0H: All stations with group numbers 0001H to 0020H (Can be set when the execution type specified by (s1) is "0: No arrival acknowledgment") <p>(3) All-station specification</p> <ul style="list-style-type: none"> • 00FFH: All stations of target network number (broadcast (excluding the own station)) (Can be set when the execution type specified by (s1) is "0: No arrival acknowledgment") <p>■When "1" is specified in bit 15 of (s1)+0 Specify the IP address (first and second octets) of the target station.</p> <p>b15 ... b8 b7 ... b0</p> <table border="1" style="margin-left: auto; margin-right: auto;"> <tr> <td style="width: 40px; height: 15px;"></td> <td style="width: 40px; height: 15px;"></td> </tr> </table> <ul style="list-style-type: none"> • b8 to b15: 1st octet • b0 to b7: 2nd octet 			<p>■(s1)+4</p> <ul style="list-style-type: none"> • Network number: 1 to 239 <p>■(s1)+5</p> <ul style="list-style-type: none"> • Station number: 1 to 120, 125 • Group number: 0081H to 00A0H • All-station specification: 00FFH <p>■(s1)+4, 5</p> <ul style="list-style-type: none"> • IP address: 00000001H to FFFFFFFEH 	User
+6	Not used	—	—	—		
+7	Number of resends	<p>Effective when the execution type specified by (s1) is "1: Arrival acknowledgment used".</p> <p>■Before instruction execution Specify the number of resends to be performed if the instruction is not completed within the monitoring time specified by (s1)+8.</p> <ul style="list-style-type: none"> • 0 to 15 times <p>■At completion of instruction The number of resends performed (result) is stored.</p> <ul style="list-style-type: none"> • 0 to 15 times 	0 to 15	User/ system		

Operand: (s1)														
Device	Item	Description	Setting range	Set by										
+8	Arrival monitoring time	[CC-Link IE TSN, CC-Link IE Controller Network, CC-Link IE Field Network, or MELSECNET/H] Specify the monitoring time until completion of processing. If processing is not completed within the monitoring time, the request is resent by the number of resends specified in (s1)+7. <ul style="list-style-type: none"> ■When "0" is specified in bit 8 of (s1)+0 <ul style="list-style-type: none"> • 0: 10s • 1 to 32767: 1 to 32767s ■When "1" is specified in bit 8 of (s1)+0 <ul style="list-style-type: none"> • 0: 10s • 1 to 65535: 1 to 65535 × 100ms 	0 to 65535	User										
		[Ethernet] Specify the monitoring time until completion of processing. If processing is not completed within the monitoring time, the request is resent by the number of resends specified in (s1)+7. <ul style="list-style-type: none"> ■When "0" is specified in bit 8 of (s1)+0 Specify the TCP resend timer value or greater for the monitoring time till completion of processing. <ul style="list-style-type: none"> • 0 to (TCP resend timer value): The TCP resend timer value is assumed as the monitoring time. • (TCP resend timer value + 1) to 16383: (TCP resend timer value + 1) to 16383s ■When "1" is specified in bit 8 of (s1)+0 <ul style="list-style-type: none"> • 0: 10s • 1 to 65535: 1 to 65535 × 100ms 	0 to 65535	User										
+9	Write data length	Specify the number of words to be written. <ul style="list-style-type: none"> ■Writing to RCP, QCPU, or LCP <ul style="list-style-type: none"> • Channels 1 to 8 are used: 1 to 960 (words) • Channels 9 and 10 are used: 1 to 8192 (words) ■Writing to QnACPU <ul style="list-style-type: none"> • 1 to 480 (words) 	1 to 8192	User										
+10	Not used	—	—	—										
+11	Clock setting flag	The validity status (valid or invalid) of the data in (s1)+12 and later is stored. Note that the data in (s1)+12 and later is not cleared even when the instruction is completed successfully. <ul style="list-style-type: none"> • 0: Invalid • 1: Valid 	—	System										
+12	Clock data (Set only in an abnormal state)	Upper 8 bits: Month (01H to 12H) Lower 8 bits: Lower 2 digits of year (00H to 99H)	—	System										
+13		Upper 8 bits: Hour (00H to 23H) Lower 8 bits: Day (01H to 31H)	—	System										
+14		Upper 8 bits: Second (00H to 59H) Lower 8 bits: Minute (00H to 59H)	—	System										
+15		Upper 8 bits: Year (00H to 99H: Upper two digits of the year) Lower 8 bits: Day of the week (00H (Sun.) to 06H (Sat.))	—	System										
+16		Error detection network number	<ul style="list-style-type: none"> ■When "0" is specified in bit 15 of (s1)+0 The network number of the station in which an error was detected is stored. (No information is stored if an error is detected in the own station.) <ul style="list-style-type: none"> • 1 to 239 (Network number) ■When "1" is specified in bit 15 of (s1)+0 (Ethernet and CC-Link IE TSN) The IP address (third and fourth octets) in which an error is detected is stored. <div style="text-align: center; margin-top: 10px;"> b15 ... b8 b7 ... b0 <table border="1" style="margin: auto; border-collapse: collapse;"> <tr> <td style="width: 40px; height: 15px;"></td> <td style="width: 40px;"></td> <td style="width: 40px;"></td> <td style="width: 40px;"></td> <td style="width: 40px;"></td> <td style="width: 40px;"></td> <td style="width: 40px;"></td> <td style="width: 40px;"></td> <td style="width: 40px;"></td> <td style="width: 40px;"></td> </tr> </table> </div> <ul style="list-style-type: none"> • b8 to b15: 3rd octet • b0 to b7: 4th octet 											—

Operand: (s1)						
Device	Item	Description	Setting range	Set by		
+17	Error-detected station number	<p>■When "0" is specified in bit 15 of (s1)+0 The station number of the station where an error was detected is stored. (No information is stored if an error is detected in the own station.) [Ethernet or CC-Link IE Controller Network]</p> <ul style="list-style-type: none"> • 1 to 120: Station number <p>[CC-Link IE Field Network]</p> <ul style="list-style-type: none"> • 125: Master station • 1 to 120: Local station, intelligent device station, submaster station <p>[CC-Link IE TSN]</p> <ul style="list-style-type: none"> • 125: Master station • 1 to 120: Slave station <p>[MELSECNET/H]</p> <ul style="list-style-type: none"> • 1 to 64: Station number <p>■When "1" is specified in bit 15 of (s1)+0 (Ethernet and CC-Link IE TSN) The IP address (first and second octets) of the station where an error was detected is stored.</p> <div style="border: 1px solid black; padding: 5px; margin: 10px 0;"> <p style="text-align: center;">b15 ... b8 b7 ... b0</p> <table style="width: 100%; border-collapse: collapse;"> <tr> <td style="border: 1px solid black; width: 50%; height: 20px;"></td> <td style="border: 1px solid black; width: 50%; height: 20px;"></td> </tr> </table> </div> <ul style="list-style-type: none"> • b8 to b15: 1st octet • b0 to b7: 2nd octet 			—	System

Point

- The continuous area (a maximum of 8192 words) for the write data length ((s1)+9) is required in the write data storage device (d1).
- When a number from 1 to 120 (for CC-Link IE Controller Network, CC-Link IE Field Network, or CC-Link IE TSN) or a number from 1 to 64 (for MELSECNET/H) is specified for the target station number, the instruction should be executed with the execution type set to "Arrival acknowledgment used" to improve data reliability. When a number from 81H to A0H or FFH is specified for the target station number, execute the instruction with the execution type set to "No arrival acknowledgment".
- When performing device writing to the same station from multiple stations, do not overlap the write timing. When the execution type is set to "No arrival acknowledgment", successful completion results in the write source station if communication is completed successfully even when the send data contains an error. Also, even when the send data is normal, a timeout results in the write source station if the WRITE instructions are executed for the same station from multiple stations.
- The number of resends (s1)+7 must be set every time the WRITE instruction is executed.

Processing details

- These instructions write the data in the device/label specified by (s2) in the own station to the word device in the target station specified by the target network number and target station number of the control data or the target station specified by the IP address. Upon completion of writing device data to another station number, the completion device specified by (d2) turns on.
- For the target stations that can be specified, refer to the following.

☞ Page 65 Target networks and target station types

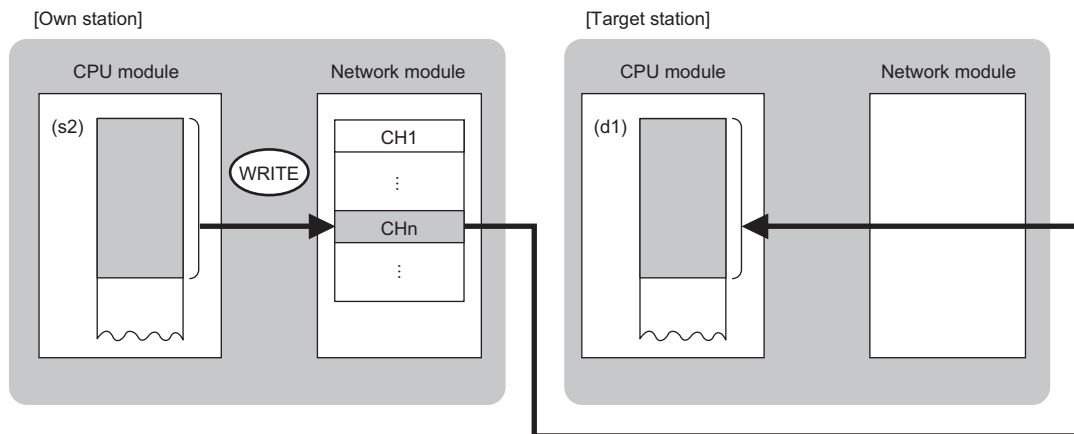

CH: Channel

- When "network number" and "station number" are specified ("0" is specified in bit 15 of (s1)+0) by the target station address specification method, device data can be written also to the stations connected to networks other than the stations connected to the own station network. (If "IP address" is specified ("1" is specified in bit 15 of (s1)+0), device data cannot be read from stations connected via a relay station.)
- When executing multiple link dedicated instructions concurrently, be careful not to overlap the channels of the link dedicated instructions. Multiple link dedicated instructions specifying the same channel cannot be used concurrently.
- The execution status and the completion status of the WRITE instruction can be checked with the completion device (d2) and the completion status indication device (d2)+1.

- Completion device (d2)

This device turns on during END processing of the scan where the WRITE instruction completes, and turns off during the next END processing.

- Completion status indication device (d2)+1

This device turns on or off depending on the completion status of the WRITE instruction.

When completed successfully: The device remains off.

When completed with an error: The device turns on during END processing of the scan where the WRITE instruction completes, and turns off during the next END processing.

• The following figure shows the execution timing of the WRITE instruction.

• When completed successfully

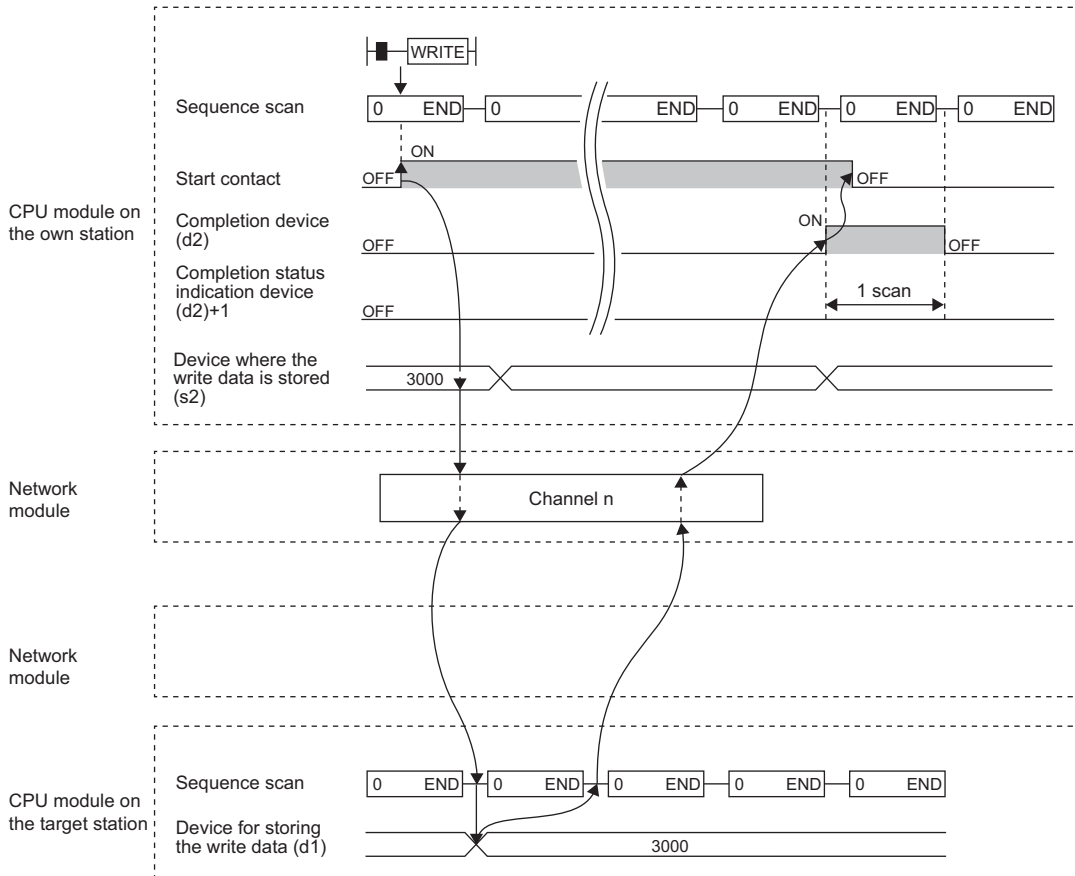



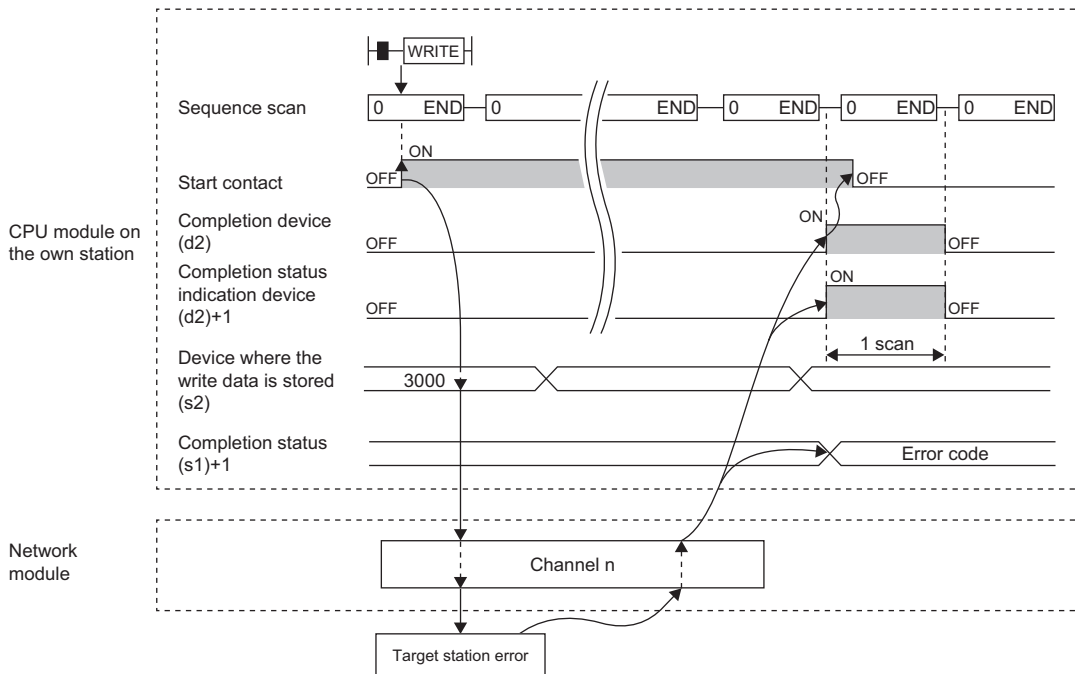







• When completed with an error



• Write processing is performed only once on the rising edge when the write command turns on.

Operation error

Error code ((s1)+1)	Description
4000H to 4FFFH	 MELSEC iQ-R CPU Module User's Manual (Application)
6F00H to 6FFFH	 MELSEC iQ-R CPU Module User's Manual (Application)
C000H to CFBFH	 MELSEC iQ-R Ethernet User's Manual (Application)  MELSEC iQ-R CC-Link IE TSN User's Manual (Application)
CFC0H to CFFFH	 MELSEC iQ-R CPU Module User's Manual (Application)  MELSEC iQ-R CC-Link IE TSN User's Manual (Application)
D000H to DFFFH	 MELSEC iQ-R CC-Link IE Field Network User's Manual (Application)  MELSEC iQ-R CC-Link IE TSN User's Manual (Application)
E000H to EFFFH	 MELSEC iQ-R CC-Link IE Controller Network User's Manual (Application)
F000H to FFFFH	 MELSEC iQ-R MELSECNET/H Network Module User's Manual (Application)

Writing data to the programmable controller on another station (with notification)

JP.SWRITE, GP.SWRITE

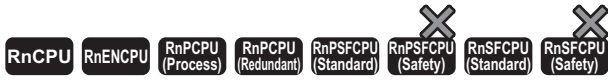

These instructions write data to a device in the programmable controller of another station (in units of words).

After the data writing is completed by the SWRITE instruction, the device of another station is turned on. The other station can recognize that data has been written by the SWRITE instruction.

Ladder	ST
	<pre>ENO:=JP_SWRITE(EN,J,s1,s2,d1,d2,d3); ENO:=GP_SWRITE(EN,U,s1,s2,d1,d2,d3);</pre>

FBD/LD

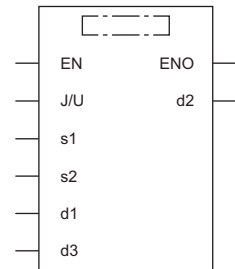

Execution condition

Instruction	Execution condition
JP.SWRITE GP.SWRITE	

Setting data

■Description, range, data type

Operand		Description	Range	Data type	Data type (label)
(J/U)	JP.SWRITE	(J): Own station network number	1 to 239	16-bit unsigned binary	ANY16
	GP.SWRITE	(U): Start I/O number (first three digits in four-digit hexadecimal representation) of own station or own node	00H to FEH	16-bit unsigned binary	ANY16
(s1)		Own station start device where control data is stored	Refer to the control data.	Device name	ANY16 ^{*1}
(s2)		Own station start device where data to be written is stored	—	Device name	ANY16 ^{*1}
(d1)		Target station start device where data is to be written	—	String ^{*2}	ANYSTRING_SINGLE ^{*2}
(d2)		Device of the own station, which turns on for one scan upon completion of the instruction. When the instruction completes with an error, (d2)+1 also turns on.	—	Bit	ANYBIT_ARRAY (Number of elements: 2)
(d3)		Target station device that is turned on for one scan upon completion of instruction (enabling the target station to recognize that data has been written from another station)	—	String ^{*2}	ANYSTRING_SINGLE ^{*2}
EN		Execution condition	—	Bit	BOOL
ENO		Execution result	—	Bit	BOOL

*1 When specifying setting data by using a label, define an array to secure enough operation area and specify an element of the array label.

*2 For the specifications of the string data to be specified, refer to the following.

 Page 70 Specifications of character string data specified by link dedicated instructions

■Applicable devices

Operand	Bit		Word			Double word		Indirect specification	Constant			Others	
	X, Y, M, L, SM, F, B, SB, FX, FY	J□□□	T, ST, C, D, W, SD, SW, FD, R, ZR, RD	U□\G□, J□\□, U3E□\□(H)G□	Z	LT, LST, LC	LZ		K, H	E	\$	J	U
(J/U)	JP.SWRITE	—	—	—	—	—	—	—	—	—	—	—	—
	GP.SWRITE	—	—	○	—	—	—	○	○	—	—	—	○
(s1)		—	—	○ ^{*2}	—	—	—	○	—	—	—	—	—
(s2)		—	—	○ ^{*2}	—	—	—	○	—	—	—	—	—
(d1)		—	—	—	—	—	—	—	—	—	○	—	—
(d2)		○ ^{*1}	—	○ ^{*3}	—	—	—	—	—	—	—	—	—
(d3)		—	—	—	—	—	—	—	—	—	○	—	—

*1 FX and FY cannot be used.

*2 FD cannot be used.

*3 T, ST, C, and FD cannot be used.

- The SWRITE instruction cannot be executed when the target station is ACPU.
- Specify the target station start device (d1) where data is to be written by considering the range in which the data that has been written can be stored.

(Example: When areas D150 and after in the target station CPU module are already in use)

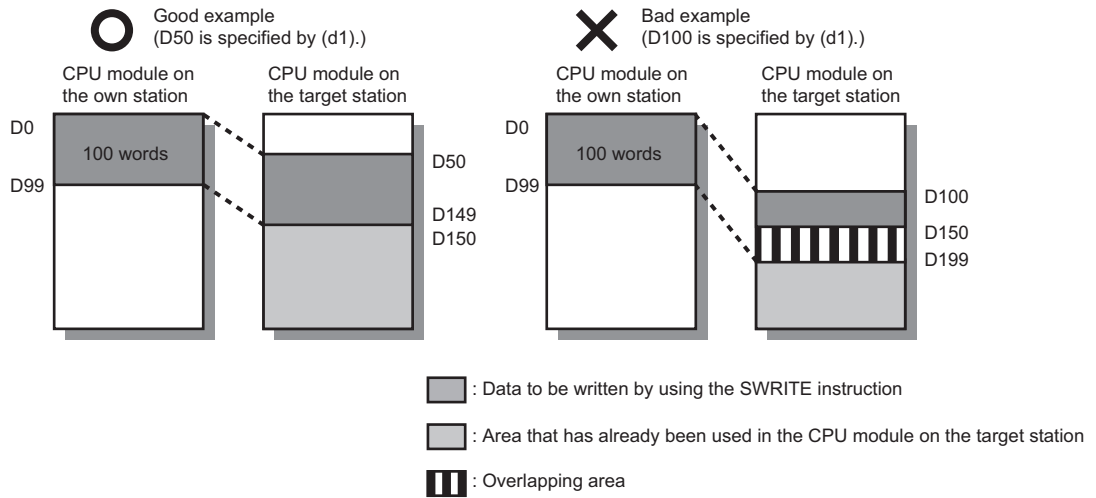

- When the target station for which the SWRITE instruction is executed is the basic model QCPU, the write notification device for the target station specified by argument (d3) is ignored. The operations of the SWRITE instruction are the same as those of the WRITE instruction.
- The SWRITE instruction can be programmed by omitting argument (d3). However, the operations are the same as those of the WRITE instruction. The operations of the SWRITE instruction can be selected according to whether (d3) is omitted or not.

Control data

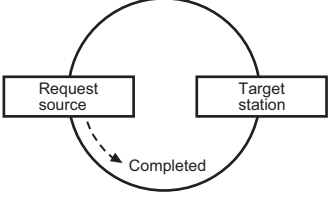
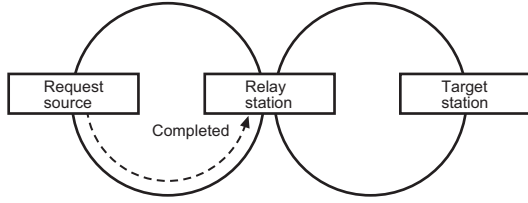
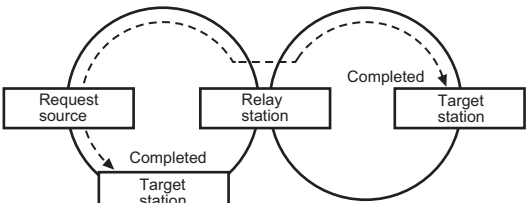
Operand: (s1)				
Device	Item	Description	Setting range	Set by
+0	Execution/error completion type	<p>b15 ... b8 b7 ... b0</p> <p>(4) 0 (3)(2) 0 (1)</p> <p>(1) Execution type (bit 0)</p> <ul style="list-style-type: none"> • 0: No arrival acknowledgment <p>When the target station is in the same network: Completed when data has been sent from the own station.</p>  <p>When the target station is in another network: Completed when data has arrived the relay station of the own network.</p>  <ul style="list-style-type: none"> • 1: Arrival acknowledgment used <p>Sending data is completed when the data is written to the target station.</p>  <p>(2) Error completion type (bit 7)</p> <p>Specify whether to set clock data at completion with an error.</p> <ul style="list-style-type: none"> • 0: Do not set data in (s1)+11 and later at completion with an error. • 1: Set data in (s1)+11 and later at completion with an error. <p>(3) Arrival check time setting (bit 8)</p> <ul style="list-style-type: none"> • 0: 1s units • 1: 100ms units <p>(4) Target station address specification method (b15)</p> <ul style="list-style-type: none"> • 0: Specify "network number" in (s1)+4, and specify "station number" in (s1)+5. • 1: Specify "IP address" in (s1)+4, 5 (Ethernet and CC-Link IE TSN). 	0000H 0001H 0080H 0081H 0100H 0101H 0180H 0181H 8000H 8001H 8080H 8081H 8100H 8101H 8180H 8181H	User
+1	Completion status	<p>The completion status is stored upon completion of the instruction.</p> <ul style="list-style-type: none"> • 0: Normal • Other than 0: Error (error code) 	—	System
+2	Own station channel	<p>Specify the channel to be used by own station. (📖 Page 66 Range of available channels)</p>	1 to 18	User
+3	Target station CPU type	<p>Specify the CPU type of the target station.</p> <ul style="list-style-type: none"> • 0000H: Addressed to target station CPU (control CPU) • 03D0H: Addressed to control system CPU • 03D1H: Addressed to standby system CPU • 03D2H: Addressed to system A CPU • 03D3H: Addressed to system B CPU • 03E0H: Addressed to multiple CPU No.1 • 03E1H: Addressed to multiple CPU No.2 • 03E2H: Addressed to multiple CPU No.3 • 03E3H: Addressed to multiple CPU No.4 • 03FFH: Addressed to target station CPU (control CPU) 	0000H 03D0H to 03D3H 03E0H to 03E3H 03FFH	User

Operand: (s1)						
Device	Item	Description	Setting range	Set by		
+4	Target network number	<p>[CC-Link IE Controller Network, CC-Link IE Field Network, or MELSECNET/H] Specify the network number (1 to 239) of the target station.</p> <p>[Ethernet or CC-Link IE TSN] ■When "0" is specified in bit 15 of (s1)+0 Specify the network number (1 to 239) of the target station. ■When "1" is specified in bit 15 of (s1)+0 Specify the IP address (third and fourth octets) of the target station.</p> <p>b15 ... b8 b7 ... b0</p> <table border="1" style="width: 100%; border-collapse: collapse;"> <tr> <td style="width: 50%; height: 15px;"></td> <td style="width: 50%; height: 15px;"></td> </tr> </table> <ul style="list-style-type: none"> • b8 to b15: 3rd octet • b0 to b7: 4th octet 			<p>■(s1)+4</p> <ul style="list-style-type: none"> • Network number: 1 to 239 <p>■(s1)+5</p> <ul style="list-style-type: none"> • Station number: 1 to 120, 125, 126 • Group number: 0081H to 00A0H • All-station specification: 00FFH 	User
+5	Target station number	<p>[CC-Link IE Controller Network] Specify the station number of the target station.</p> <p>(1) Station number specification</p> <ul style="list-style-type: none"> • 1 to 120: Station number <p>(2) Group number specification</p> <ul style="list-style-type: none"> • 0081H to 00A0H: All stations with group numbers 0001H to 0020H (Can be set when the execution type specified by (s1) is "0: No arrival acknowledgment") <p>(3) All-station specification</p> <ul style="list-style-type: none"> • 00FFH: All stations of target network number (broadcast (excluding the own station)) (Can be set when the execution type specified by (s1) is "0: No arrival acknowledgment") <p>[CC-Link IE Field Network] Specify the station number of the target station.</p> <p>(1) Station number specification</p> <ul style="list-style-type: none"> • 125: Master station • 126: Master operating station • 1 to 120: Local station, intelligent device station, submaster station <p>(2) All-station specification</p> <ul style="list-style-type: none"> • 00FFH: All stations of target network number (broadcast (excluding the own station)) (Can be set when the execution type specified by (s1) is "0: No arrival acknowledgment") <p>[Ethernet] ■When "0" is specified in bit 15 of (s1)+0 Specify the station number of the target station.</p> <p>(1) Station number specification</p> <ul style="list-style-type: none"> • 1 to 120: Station number <p>(2) Group number specification</p> <ul style="list-style-type: none"> • 0081H to 00A0H: All stations with group numbers 0001H to 0020H (Can be set when the execution type specified by (s1) is "0: No arrival acknowledgment") <p>(3) All-station specification</p> <ul style="list-style-type: none"> • 00FFH: All stations of target network number (broadcast (excluding the own station)) (Can be set when the execution type specified by (s1) is "0: No arrival acknowledgment") <p>■When "1" is specified in bit 15 of (s1)+0 Specify the IP address (first and second octets) of the target station.</p> <p>b15 ... b8 b7 ... b0</p> <table border="1" style="width: 100%; border-collapse: collapse;"> <tr> <td style="width: 50%; height: 15px;"></td> <td style="width: 50%; height: 15px;"></td> </tr> </table> <ul style="list-style-type: none"> • b8 to b15: 1st octet • b0 to b7: 2nd octet 			<p>■(s1)+4, 5</p> <ul style="list-style-type: none"> • IP address: 0000001H to FFFFFFFEH 	User

Operand: (s1)						
Device	Item	Description	Setting range	Set by		
+5	Target station number	<p>[CC-Link IE TSN]</p> <p>■When "0" is specified in bit 15 of (s1)+0 Specify the station number of the target station.</p> <p>(1) Station number specification</p> <ul style="list-style-type: none"> • 1 to 120: Local station • 125: Master station <p>(2) Group number specification</p> <ul style="list-style-type: none"> • 0081H to 00A0H: All stations with group numbers 0001H to 0020H (Can be set when the execution type specified by (s1) is "0: No arrival acknowledgment") <p>(3) All-station specification</p> <ul style="list-style-type: none"> • 00FFH: All stations of target network number (broadcast (excluding the own station)) (Can be set when the execution type specified by (s1) is "0: No arrival acknowledgment") <p>■When "1" is specified in bit 15 of (s1)+0 Specify the IP address (first and second octets) of the target station.</p> <p>b15 ... b8 b7 ... b0</p> <table border="1" style="width: 100%; border-collapse: collapse;"> <tr> <td style="width: 50%; height: 15px;"></td> <td style="width: 50%; height: 15px;"></td> </tr> </table> <ul style="list-style-type: none"> • b8 to b15: 1st octet • b0 to b7: 2nd octet 			<p>■(s1)+4</p> <ul style="list-style-type: none"> • Network number: 1 to 239 <p>■(s1)+5</p> <ul style="list-style-type: none"> • Station number: 1 to 120, 125 • Group number: 0081H to 00A0H • All-station specification: 00FFH <p>■(s1)+4, 5</p> <ul style="list-style-type: none"> • IP address: 00000001H to FFFFFFFEH 	User
+6	Not used	—	—	—		
+7	Number of resends	<p>Effective when the execution type specified by (s1) is "1: Arrival acknowledgment used".</p> <p>■Before instruction execution Specify the number of resends to be performed if the instruction is not completed within the monitoring time specified by (s1)+8.</p> <ul style="list-style-type: none"> • 0 to 15 times <p>■At completion of instruction The number of resends performed (result) is stored.</p> <ul style="list-style-type: none"> • 0 to 15 times 	0 to 15	User/ system		

Operand: (s1)														
Device	Item	Description	Setting range	Set by										
+8	Arrival monitoring time	[CC-Link IE TSN, CC-Link IE Controller Network, CC-Link IE Field Network, or MELSECNET/H] Specify the monitoring time until completion of processing. If processing is not completed within the monitoring time, the request is resent by the number of resends specified in (s1)+7. <ul style="list-style-type: none"> ■When "0" is specified in bit 8 of (s1)+0 <ul style="list-style-type: none"> • 0: 10s • 1 to 32767: 1 to 32767s ■When "1" is specified in bit 8 of (s1)+0 <ul style="list-style-type: none"> • 0: 10s • 1 to 65535: 1 to 65535 × 100ms 	0 to 65535	User										
		[Ethernet] Specify the monitoring time until completion of processing. If processing is not completed within the monitoring time, the request is resent by the number of resends specified in (s1)+7. <ul style="list-style-type: none"> ■When "0" is specified in bit 8 of (s1)+0 Specify the TCP resend timer value or greater for the monitoring time till completion of processing. <ul style="list-style-type: none"> • 0 to (TCP resend timer value): The TCP resend timer value is assumed as the monitoring time. • (TCP resend timer value + 1) to 16383: (TCP resend timer value + 1) to 16383s ■When "1" is specified in bit 8 of (s1)+0 <ul style="list-style-type: none"> • 0: 10s • 1 to 65535: 1 to 65535 × 100ms 	0 to 65535	User										
+9	Write data length	Specify the number of words to be written. <ul style="list-style-type: none"> ■Writing to RCP, QCPU, or LCP <ul style="list-style-type: none"> • Channels 1 to 8 are used: 1 to 960 (words) • Channels 9 and 10 are used: 1 to 8192 (words) ■Writing to QnACPU <ul style="list-style-type: none"> • 1 to 480 (words) 	1 to 8192	User										
+10	Not used	—	—	—										
+11	Clock setting flag	The validity status (valid or invalid) of the data in (s1)+12 and later is stored. Note that the data in (s1)+12 and later is not cleared even when the instruction is completed successfully. <ul style="list-style-type: none"> • 0: Invalid • 1: Valid 	—	System										
+12	Clock data (Set only in an abnormal state)	Upper 8 bits: Month (01H to 12H) Lower 8 bits: Lower 2 digits of year (00H to 99H)	—	System										
+13		Upper 8 bits: Hour (00H to 23H) Lower 8 bits: Day (01H to 31H)	—	System										
+14		Upper 8 bits: Second (00H to 59H) Lower 8 bits: Minute (00H to 59H)	—	System										
+15		Upper 8 bits: Year (00H to 99H: Upper two digits of the year) Lower 8 bits: Day of the week (00H (Sun.) to 06H (Sat.))	—	System										
+16	Error detection network number	<ul style="list-style-type: none"> ■When "0" is specified in bit 15 of (s1)+0 The network number of the station in which an error was detected is stored. (No information is stored if an error is detected in the own station.) <ul style="list-style-type: none"> • 1 to 239 (Network number) ■When "1" is specified in bit 15 of (s1)+0 (Ethernet and CC-Link IE TSN) The IP address (third and fourth octets) in which an error is detected is stored. <div style="text-align: center;"> b15 ... b8 b7 ... b0 <table border="1" style="margin: auto;"> <tr> <td style="width: 40px; height: 15px;"></td> <td style="width: 40px;"></td> <td style="width: 40px;"></td> <td style="width: 40px;"></td> <td style="width: 40px;"></td> <td style="width: 40px;"></td> <td style="width: 40px;"></td> <td style="width: 40px;"></td> <td style="width: 40px;"></td> <td style="width: 40px;"></td> </tr> </table> </div> <ul style="list-style-type: none"> • b8 to b15: 3rd octet • b0 to b7: 4th octet 											—	System

Operand: (s1)						
Device	Item	Description	Setting range	Set by		
+17	Error-detected station number	<p>■When "0" is specified in bit 15 of (s1)+0 The station number of the station where an error was detected is stored. (No information is stored if an error is detected in the own station.) [Ethernet or CC-Link IE Controller Network]</p> <ul style="list-style-type: none"> • 1 to 120: Station number <p>[CC-Link IE Field Network]</p> <ul style="list-style-type: none"> • 125: Master station • 1 to 120: Local station, intelligent device station, submaster station <p>[CC-Link IE TSN]</p> <ul style="list-style-type: none"> • 125: Master station • 1 to 120: Slave station <p>[MELSECNET/H]</p> <ul style="list-style-type: none"> • 1 to 64: Station number <p>■When "1" is specified in bit 15 of (s1)+0 (Ethernet and CC-Link IE TSN) The IP address (first and second octets) of the station where an error was detected is stored.</p> <div style="text-align: center;"> <p>b15 ... b8 b7 ... b0</p> <table border="1" style="margin: auto;"> <tr> <td style="width: 100px; height: 15px;"></td> <td style="width: 100px; height: 15px;"></td> </tr> </table> </div> <ul style="list-style-type: none"> • b8 to b15: 1st octet • b0 to b7: 2nd octet 			—	System

Point

- The continuous area (a maximum of 8192 words) for the write data length ((s1)+9) is required in the write data storage device (d1).
- When a number from 1 to 120 (for CC-Link IE Controller Network, CC-Link IE Field Network, or CC-Link IE TSN) or a number from 1 to 64 (for MELSECNET/H) is specified for the target station number, the instruction should be executed with the execution type set to "Arrival acknowledgment used" to improve data reliability. When a number from 81H to A0H or FFH is specified for the target station number, execute the instruction with the execution type set to "No arrival acknowledgment".
- When performing device writing to the same station from multiple stations, do not overlap the write timing. When the execution type is set to "No arrival acknowledgment", successful completion results in the write source station if communication is completed successfully even when the send data contains an error. Also, even when the send data is normal, a timeout results in the write source station if the SWRITE instructions are executed for the same station from multiple stations.
- The number of resends (s1)+7 must be set every time the SWRITE instruction is executed.

Processing details

- These instructions write the data in the device/label specified by (s2) in the own station to the word device in the target station specified by the target network number and target station number of the control data or the target station specified by the IP address. Upon completion of writing device data to another station number, the completion device specified by (d2) turns on. In another station, upon completion of writing the device data specified by (s2), the device specified by (d3) turns on.
- For the target stations that can be specified, refer to the following.

☞ Page 65 Target networks and target station types

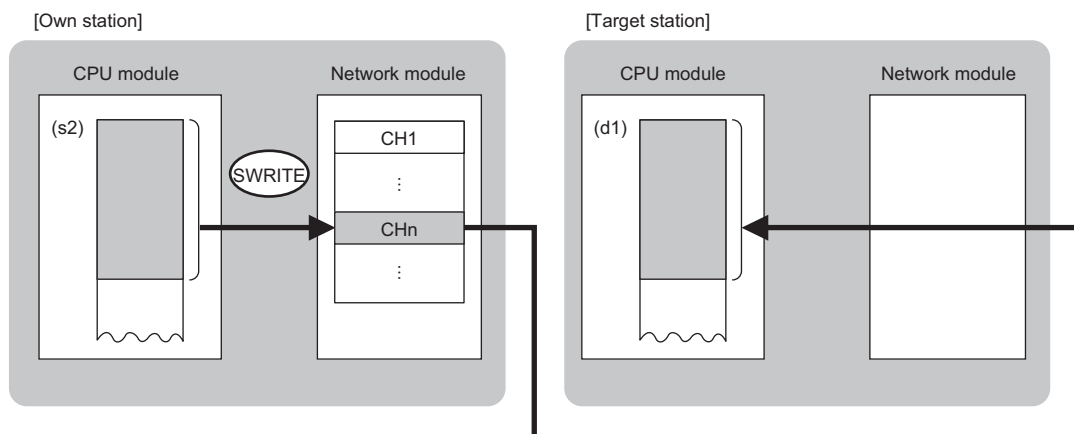

CH: Channel

- When "network number" and "station number" are specified ("0" is specified in bit 15 of (s1)+0) by the target station address specification method, device data can be written also to the stations connected to networks other than the stations connected to the own station network. (If "IP address" is specified ("1" is specified in bit 15 of (s1)+0), device data cannot be read from stations connected via a relay station.)
- When executing multiple link dedicated instructions concurrently, be careful not to overlap the channels of the link dedicated instructions. Multiple link dedicated instructions specifying the same channel cannot be used concurrently.
- The execution status and the completion status of the SWRITE instruction can be checked with the completion device (d2) and the completion status indication device (d2)+1.

- Completion device (d2)

This device turns on during END processing of the scan where the SWRITE instruction completes, and turns off during the next END processing.

- Completion status indication device (d2)+1

This device turns on or off depending on the completion status of the SWRITE instruction.

When completed successfully: The device remains off.

When completed with an error: The device turns on during END processing of the scan where the SWRITE instruction completes, and turns off during the next END processing.

• The following figure shows the execution timing of the SWRITE instruction.

• When completed successfully

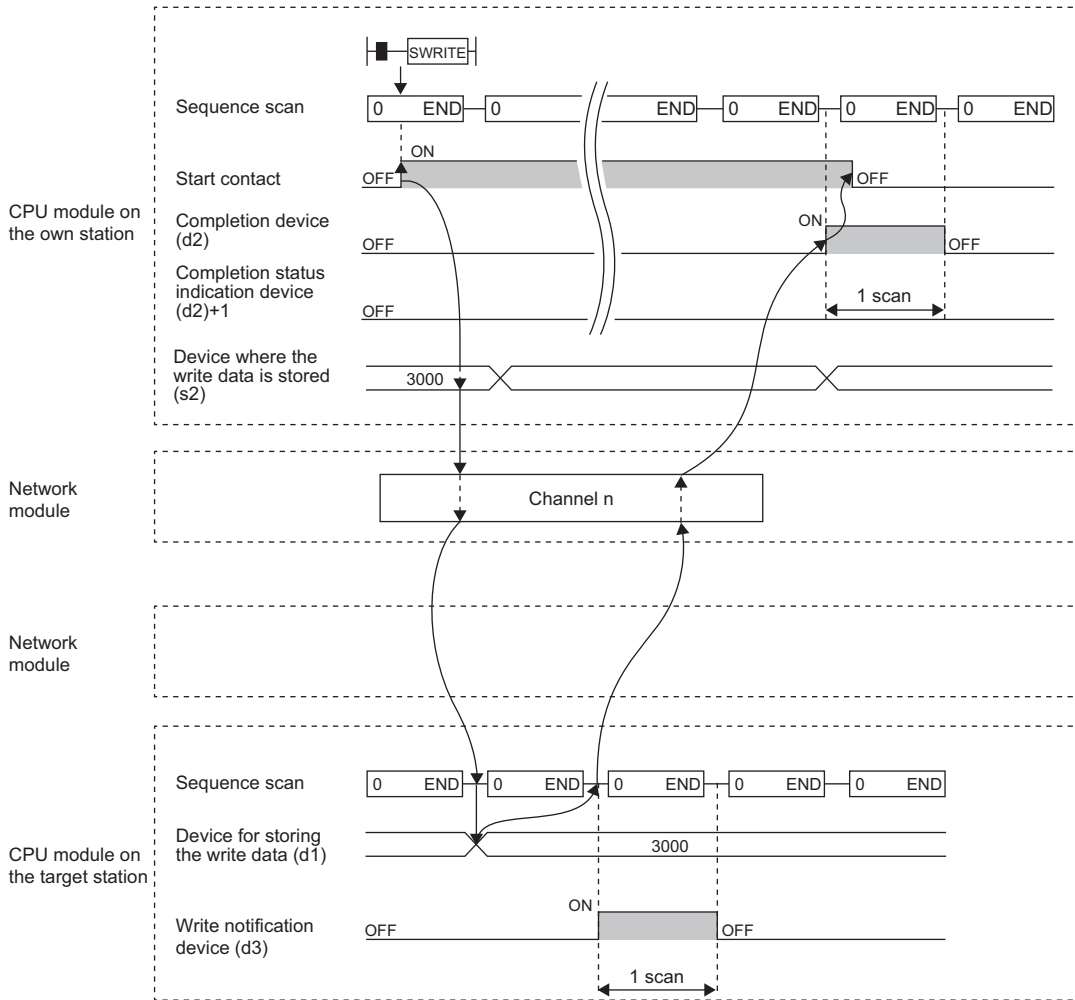



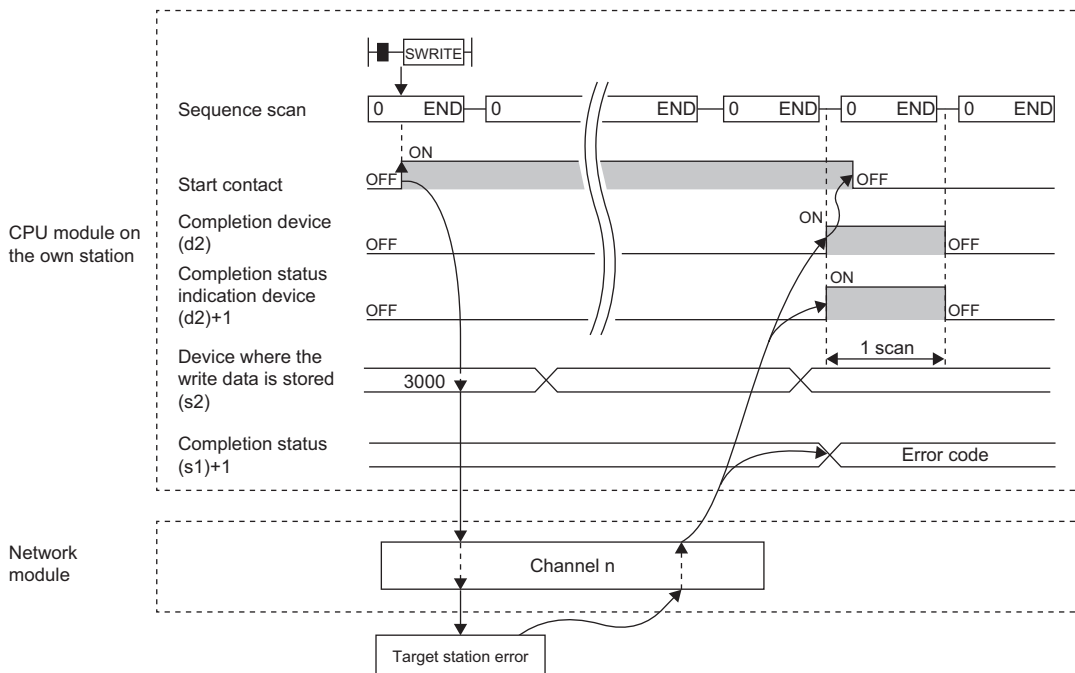







• When completed with an error



• Write processing is performed only once on the rising edge when the write command turns on.

Operation error

Error code ((s1)+1)	Description
4000H to 4FFFH	 MELSEC iQ-R CPU Module User's Manual (Application)
6F00H to 6FFFH	 MELSEC iQ-R CPU Module User's Manual (Application)
C000H to CFBFH	 MELSEC iQ-R Ethernet User's Manual (Application)  MELSEC iQ-R CC-Link IE TSN User's Manual (Application)
CFC0H to CFFFH	 MELSEC iQ-R CPU Module User's Manual (Application)  MELSEC iQ-R CC-Link IE TSN User's Manual (Application)
D000H to DFFFH	 MELSEC iQ-R CC-Link IE Field Network User's Manual (Application)  MELSEC iQ-R CC-Link IE TSN User's Manual (Application)
E000H to EFFFH	 MELSEC iQ-R CC-Link IE Controller Network User's Manual (Application)
F000H to FFFFH	 MELSEC iQ-R MELSECNET/H Network Module User's Manual (Application)

Sending data to the programmable controller on another station

JP.SEND, GP.SEND

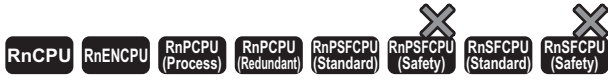

These instructions send data to the programmable controller of another station.

Ladder	ST
	<pre>ENO:=JP_SEND(EN,J,s1,s2,d); ENO:=GP_SEND(EN,U,s1,s2,d);</pre>

FBD/LD

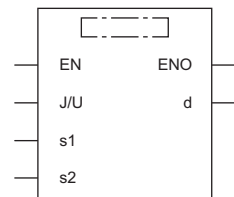

Execution condition

Instruction	Execution condition
JP.SEND GP.SEND	

Setting data

Description, range, data type

Operand	Description	Range	Data type	Data type (label)
(J/U)	JP.SEND (J): Own station network number GP.SEND (U): Start I/O number (first three digits in four-digit hexadecimal representation) of own station or own node	1 to 239 00H to FEH	16-bit unsigned binary 16-bit unsigned binary	ANY16 ANY16
(s1)	Own station start device where control data is stored	Refer to the control data.	Device name	ANY16 ^{*1}
(s2)	Own station head device where send data is stored	—	Device name	ANY16 ^{*1}
(d)	Device of the own station, which turns on for one scan upon completion of the instruction. When the instruction completes with an error, (d)+1 also turns on.	—	Bit	ANYBIT_ARRAY (Number of elements: 2)
EN	Execution condition	—	Bit	BOOL
ENO	Execution result	—	Bit	BOOL

*1 When specifying setting data by using a label, define an array to secure enough operation area and specify an element of the array label.

Point

The SEND instruction cannot be executed when the target station is ACPU.

■Applicable devices

Operand	Bit		Word			Double word		Indirect specification	Constant			Others	
	X, Y, M, L, SM, F, B, SB, FX, FY	J□□	T, ST, C, D, W, SD, SW, FD, R, ZR, RD	U□\G□, J□□□, U3E□(H)G□	Z	LT, LST, LZ	—		K, H, E, \$	J, U			
(J/U)	JP.SEND	—	—	—	—	—	—	—	—	—	—	—	—
	GP.SEND	—	—	○	—	—	—	○	○	—	—	—	○
(s1)		—	—	○*2	—	—	—	○	—	—	—	—	—
(s2)		—	—	○*2	—	—	—	○	—	—	—	—	—
(d)		○*1	—	○*3	—	—	—	—	—	—	—	—	—

*1 FX and FY cannot be used.

*2 FD cannot be used.

*3 T, ST, C, and FD cannot be used.

■Control data

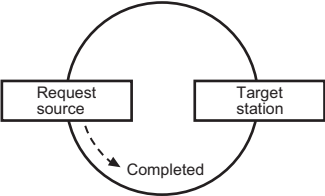
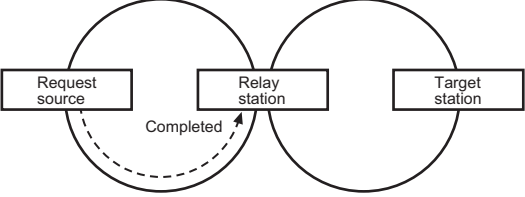
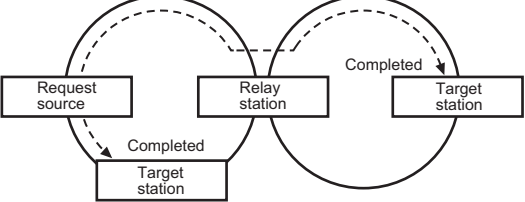
Operand: (s1)				
Device	Item	Description	Setting range	Set by
+0	Execution/error completion type	<p>b15 ... b7 ... b0</p> <p>(3) 0 (2) 0 (1)</p> <p>(1) Execution type (bit 0)</p> <ul style="list-style-type: none"> • 0: No arrival acknowledgment <p>When the target station is in the same network: Completed when data has been sent from the own station.</p>  <p>When the target station is in another network: Completed when data has arrived the relay station of the own network.</p>  <ul style="list-style-type: none"> • 1: Arrival acknowledgment used <p>Completed when data has been stored in the specified channel of the target station.</p>  <p>(2) Error completion type (bit 7)</p> <p>Specify whether to set clock data at completion with an error.</p> <ul style="list-style-type: none"> • 0: Clock data at error occurrence is not stored in (s1)+11 and later. • 1: Clock data at error occurrence is stored in (s1)+11 and later. <p>(3) Target station address specification method (bit 15) (CC-Link IE TSN only)</p> <ul style="list-style-type: none"> • 0: Specify "network number" in (s1)+4, and specify "station number" in (s1)+5. • 1: Specify "IP address" in (s1)+4, 5. 	0000H 0001H 0080H 0081H 8000H 8001H 8080H 8081H	User
+1	Completion status	The completion status is stored upon completion of the instruction.	—	System
+2	Own station channel	Specify the channel to be used by own station. (☞ Page 66 Range of available channels)	1 to 8, 11 to 18	User

Operand: (s1)				
Device	Item	Description	Setting range	Set by
+3	Target station storage channel	Specify the channel of the target station for storing data. (CC-Link IE Field Network: 1 or 2) (MELSECNET/H: 1 to 64 (for logical channels))	1 to 8	User
+4	Target network number	[Ethernet, CC-Link IE Controller Network, CC-Link IE Field Network, or MELSECNET/H] Specify the network number of the target station. • 1 to 239 (Network number)	<ul style="list-style-type: none"> ■(s1)+4 • Network number: 1 to 239 	User
		[CC-Link IE TSN] ■When "0" is specified in bit 15 of (s1)+0 Specify the network number (1 to 239) of the target station. ■When "1" is specified in bit 15 of (s1)+0 Specify the IP address (third and fourth octets) of the target station. b15 ... b8 b7 ... b0 <div style="border: 1px solid black; width: 100%; height: 15px; margin: 5px 0;"></div> <ul style="list-style-type: none"> • b8 to b15: 3rd octet • b0 to b7: 4th octet 	<ul style="list-style-type: none"> ■(s1)+5 • Station number: 1 to 120, 125, 126 • Group number: 0081H to 00A0H • All-station specification: 00FFH ■(s1)+4, 5 • IP address: 00000001H to FFFFFFFEH 	User

Operand: (s1)																
Device	Item	Description	Setting range	Set by												
+5	Target station number	<p>[Ethernet or CC-Link IE Controller Network] Specify the station number of the target station. (1) Station number specification • 1 to 120: Station number (2) Group number specification • 0081H to 00A0H: All stations with group numbers 0001H to 0020H (Can be set when the execution type specified by (s1) is "0: No arrival acknowledgment") (3) All-station specification • 00FFH: All stations of target network number (broadcast (excluding the own station)) (Can be set when the execution type specified by (s1) is "0: No arrival acknowledgment")</p> <p>[CC-Link IE Field Network] Specify the station number of the target station. (1) Station number specification • 125: Master station • 126: Master operating station • 1 to 120: Local station, intelligent device station, submaster station (2) All-station specification • 00FFH: All stations of target network number (broadcast (excluding the own station)) (Can be set when the execution type specified by (s1) is "0: No arrival acknowledgment")</p> <p>[CC-Link IE TSN] ■When "0" is specified in bit 15 of (s1)+0 Specify the station number of the target station. (1) Station number specification • 1 to 120: Local station • 125: Master station (2) Group number specification • 0081H to 00A0H: All stations with group numbers 0001H to 0020H (Can be set when the execution type specified by (s1) is "0: No arrival acknowledgment") (3) All-station specification • 00FFH: All stations of target network number (broadcast (excluding the own station)) (Can be set when the execution type specified by (s1) is "0: No arrival acknowledgment") ■When "1" is specified in bit 15 of (s1)+0 Specify the IP address (first and second octets) of the target station.</p> <table border="1" style="width: 100%; border-collapse: collapse;"> <tr> <td style="text-align: center;">b15</td> <td style="text-align: center;">...</td> <td style="text-align: center;">b8</td> <td style="text-align: center;">b7</td> <td style="text-align: center;">...</td> <td style="text-align: center;">b0</td> </tr> <tr> <td colspan="2" style="border: 1px solid black; height: 15px;"></td> <td colspan="4" style="border: 1px solid black; height: 15px;"></td> </tr> </table> <p>• b8 to b15: 1st octet • b0 to b7: 2nd octet</p> <p>[MELSECNET/H] Specify the station number of the target station. (1) Station number specification • 1 to 64: Station number (2) Group number specification • 0081H to 00A0H: All stations with group numbers 0001H to 0020H (Can be set when the execution type specified by (s1) is "0: No arrival acknowledgment") (3) All-station specification • 00FFH: All stations of target network number (broadcast (excluding the own station)) (Can be set when the execution type specified by (s1) is "0: No arrival acknowledgment")</p>	b15	...	b8	b7	...	b0							<p>■(s1)+4 • Network number: 1 to 239 ■(s1)+5 • Station number: 1 to 120, 125, 126 • Group number: 0081H to 00A0H • All-station specification: 00FFH ■(s1)+4, 5 • IP address: 0000001H to FFFFFFFEH</p>	User
b15	...	b8	b7	...	b0											
+6	Not used	—	—	—												

Operand: (s1)						
Device	Item	Description	Setting range	Set by		
+7	Number of resends (retries)	Effective when the execution type specified by (s1) is "1: Arrival acknowledgment used". <ul style="list-style-type: none"> ■Before instruction execution Specify the number of resends to be performed if the instruction is not completed within the monitoring time specified by (s1)+8. <ul style="list-style-type: none"> • 0 to 15 times ■At completion of instruction The number of resends performed (result) is stored. <ul style="list-style-type: none"> • 0 to 15 times 	0 to 15	User/system		
+8	Arrival monitoring time	[CC-Link IE TSN, CC-Link IE Controller Network, CC-Link IE Field Network, or MELSECNET/H] Specify the monitoring time until completion of processing. If processing is not completed within the monitoring time, the request is resent by the number of resends specified in (s1)+7. <ul style="list-style-type: none"> • 0: 10s • 1 to 32767: 1 to 32767s 	0 to 32767	User		
		[Ethernet] Specify the TCP resend timer value or greater for the monitoring time till completion of processing. If processing is not completed within the monitoring time, the request is resent by the number of resends specified in (s1)+7 (the number of resends). <ul style="list-style-type: none"> • 0 to (TCP resend timer value): The TCP resend timer value is assumed as the monitoring time. • (TCP resend timer value + 1) to 16383: (TCP resend timer value + 1) to 16383s 	0 to 16383	User		
+9	Send data length	Specify the number of send data from (s2) to (s2)+n. (No information is stored if an error is detected in the own station.) <ul style="list-style-type: none"> ■Sending to RCP, QCPU, or LCP <ul style="list-style-type: none"> • 1 to 960 (words) ■Sending to QnACPU <ul style="list-style-type: none"> • 1 to 480 (words) 	1 to 960, 1 to 480	User		
+10	Not used	—	—	—		
+11	Clock setting flag	The validity status (valid or invalid) of the data in (s1)+12 and later is stored. Note that the data in (s1)+12 and later is not cleared even when the instruction is completed successfully. <ul style="list-style-type: none"> • 0: Invalid • 1: Valid 	—	System		
+12	Clock data (Set only in an abnormal state)	Upper 8 bits: Month (01H to 12H) Lower 8 bits: Lower 2 digits of year (00H to 99H)	—	System		
+13		Upper 8 bits: Hour (00H to 23H) Lower 8 bits: Day (01H to 31H)	—	System		
+14		Upper 8 bits: Second (00H to 59H) Lower 8 bits: Minute (00H to 59H)	—	System		
+15		Upper 8 bits: Year (00H to 99H: Upper two digits of the year) Lower 8 bits: Day of the week (00H (Sun.) to 06H (Sat.))	—	System		
+16	Error detection network number	<ul style="list-style-type: none"> ■When "0" is specified in bit 15 of (s1)+0 The network number of the station in which an error was detected is stored. (No information is stored if an error is detected in the own station.) <ul style="list-style-type: none"> • 1 to 239 (Network number) ■When "1" is specified in bit 15 of (s1)+0 (CC-Link IE TSN only) The IP address (third and fourth octets) in which an error is detected is stored. <div style="border: 1px solid black; padding: 5px; margin: 5px 0;"> <p>b15 ... b8 b7 ... b0</p> <table style="width: 100%; border-collapse: collapse;"> <tr> <td style="border: 1px solid black; width: 50%; height: 20px;"></td> <td style="border: 1px solid black; width: 50%; height: 20px;"></td> </tr> </table> </div> <ul style="list-style-type: none"> • b8 to b15: 3rd octet • b0 to b7: 4th octet 			—	System

Operand: (s1)						
Device	Item	Description	Setting range	Set by		
+17	Error-detected station number	<p>■When "0" is specified in bit 15 of (s1)+0 The station number of the station where an error was detected is stored. (No information is stored if an error is detected in the own station.) [Ethernet or CC-Link IE Controller Network]</p> <ul style="list-style-type: none"> • 1 to 120: Station number <p>[CC-Link IE Field Network]</p> <ul style="list-style-type: none"> • 125: Master station • 1 to 120: Local station, intelligent device station, submaster station <p>[CC-Link IE TSN]</p> <ul style="list-style-type: none"> • 125: Master station • 1 to 120: Slave station <p>[MELSECNET/H]</p> <ul style="list-style-type: none"> • 1 to 64: Station number <p>■When "1" is specified in bit 15 of (s1)+0 (CC-Link IE TSN only) The IP address (first and second octets) of the station where an error was detected is stored.</p> <p>b15 ... b8 b7 ... b0</p> <table border="1" style="width: 100%; border-collapse: collapse;"> <tr> <td style="width: 50%; height: 15px;"></td> <td style="width: 50%; height: 15px;"></td> </tr> </table> <ul style="list-style-type: none"> • b8 to b15: 1st octet • b0 to b7: 2nd octet 			—	System

- The continuous area (a maximum of 960 words) for the send data length ((s1)+9) is required in the send data storage device (s2).
- When a number from 1 to 120 (for CC-Link IE Controller Network, CC-Link IE Field Network, or CC-Link IE TSN) or a number from 1 to 64 (for MELSECNET/H) is specified for the target station number, the instruction should be executed with the execution type set to "Arrival acknowledgment used" to improve data reliability. When a number from 81H to A0H or FFH is specified for the target station number, execute the instruction with the execution type set to "No arrival acknowledgment".
- When sending data to the same channel in the receiving station, execute the instruction after data has been read by the RECV instruction in the receiving station. When the execution type is set to "No arrival acknowledgment", successful completion results in the sending station if communication is completed successfully even when the send data contains an error. Also, even when the send data is normal, a timeout results in the sending station if the instructions are executed for the same station from multiple stations.
- With the execution type set to "Arrival acknowledgment used", if the sending station sends data to the same channel in the receiving station before the receiving station reads data using the RECV instruction, a buffer full error results in the sending station.

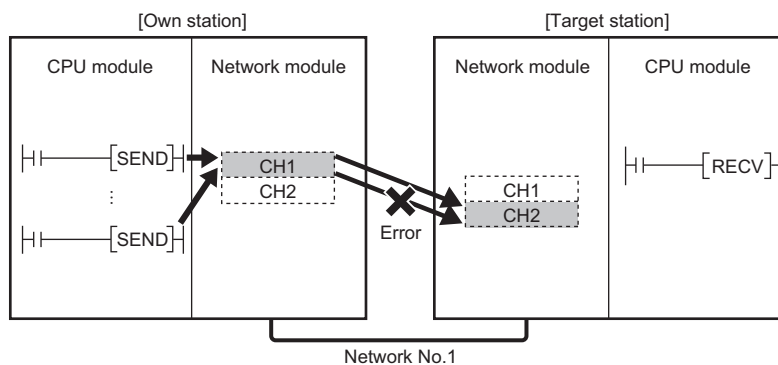

- When multiple network modules are mounted in the target station, specify the network number and station number of the network module that receives a request from the own station. (Example: In the following figure, specify station No.1 of network No.1 as a target station. (Station No.5 of network No.2. cannot be specified.))

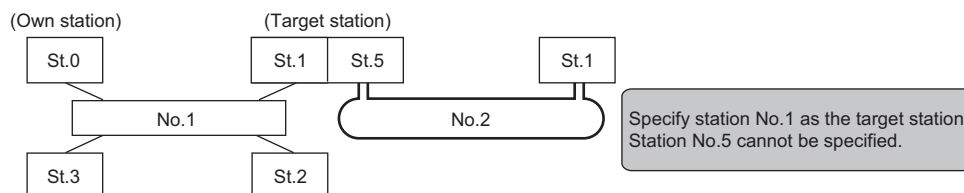

No.: Network No.

St.: Station No.

- The number of resends (s1)+7 must be set every time the instruction is executed.

Processing details

- These instructions send the data in the device specified by (s2) and later in the own station to the station connected to the target station specified by the target network number and target station number of the control data. The data that has been sent is stored in the channel specified by (s2) in the target station. To read the sent data in the target station, use the RECV/ RECVS instruction. Upon completion of sending data to the target station number, the completion device specified by (d) turns on.
- For the target stations that can be specified, refer to the following.

☞ Page 65 Target networks and target station types

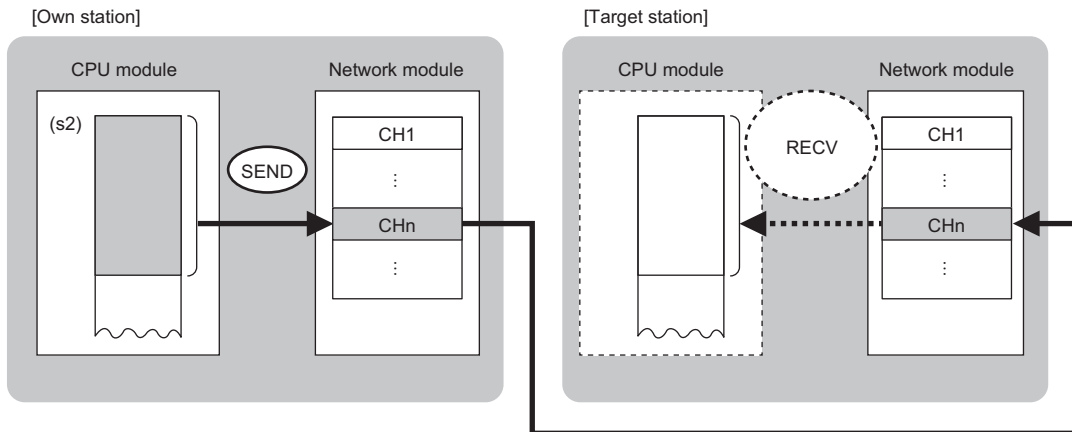

CH: Channel

- Data can be sent not only to the stations connected to the own station network, but also to stations connected to the network number specified by the following network systems. (If IP address is specified, device data cannot be read from stations connected via a relay station.)
 - Ethernet
 - CC-Link IE TSN
 - CC-Link IE Controller Network
 - CC-Link IE Field Network
 - MELSECNET/H
 - MELSECNET/10
- When executing multiple link dedicated instructions concurrently, be careful not to overlap the channels of the link dedicated instructions. Multiple link dedicated instructions specifying the same channel cannot be used concurrently.
- The execution status and the completion status of the SEND instruction can be checked with the completion device (d) and the completion status indication device (d)+1.
 - Completion device (d)

This device turns on during END processing of the scan where the SEND instruction completes, and turns off during the next END processing.

- Completion status indication device (d)+1

This device turns on or off depending on the completion status of the SEND instruction.

When completed successfully: The device remains off.

When completed with an error: The device turns on during END processing of the scan where the SEND instruction completes, and turns off during the next END processing.

- The following figure shows the execution timing of the SEND instruction.
- When completed successfully

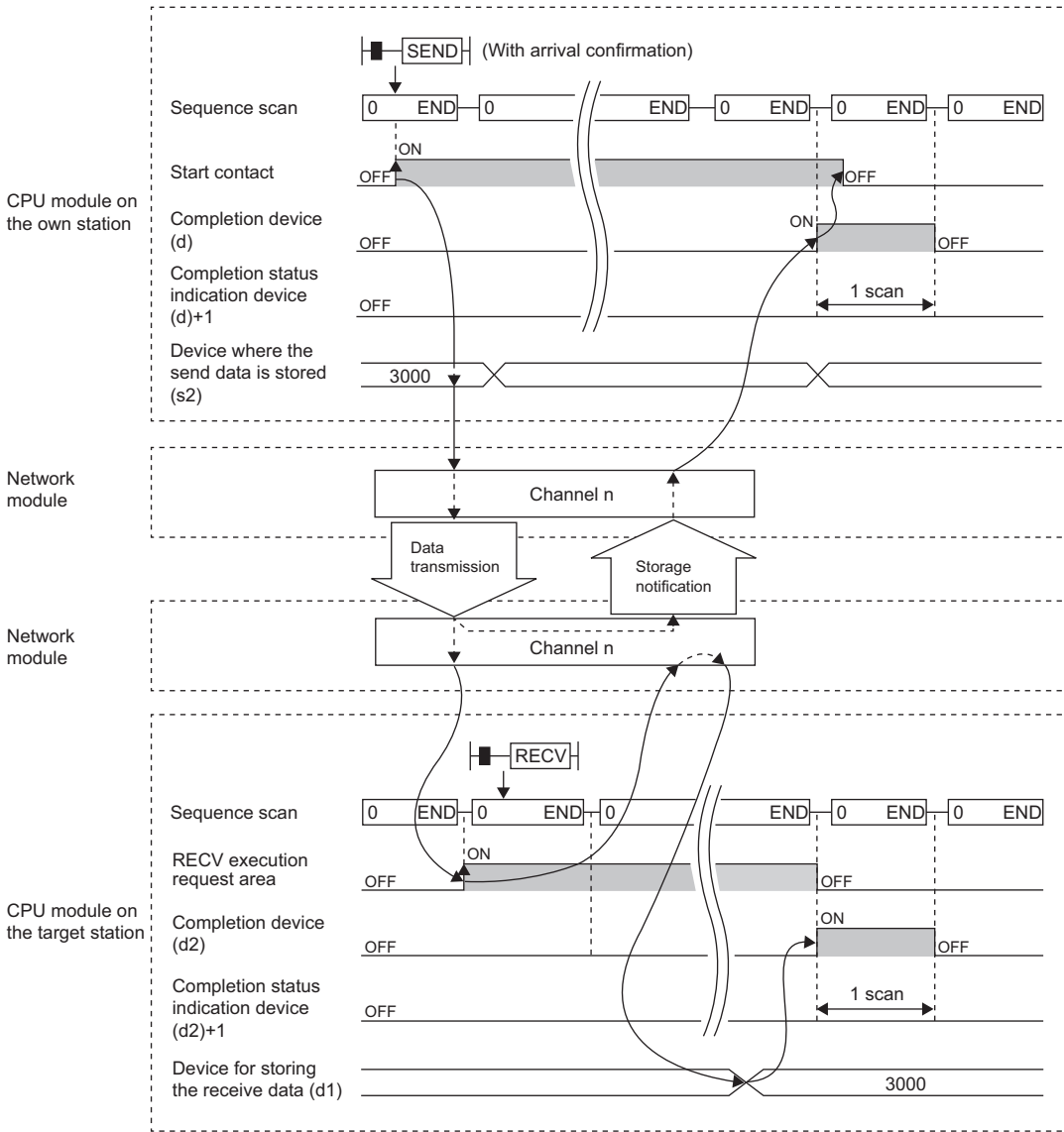

- When completed with an error

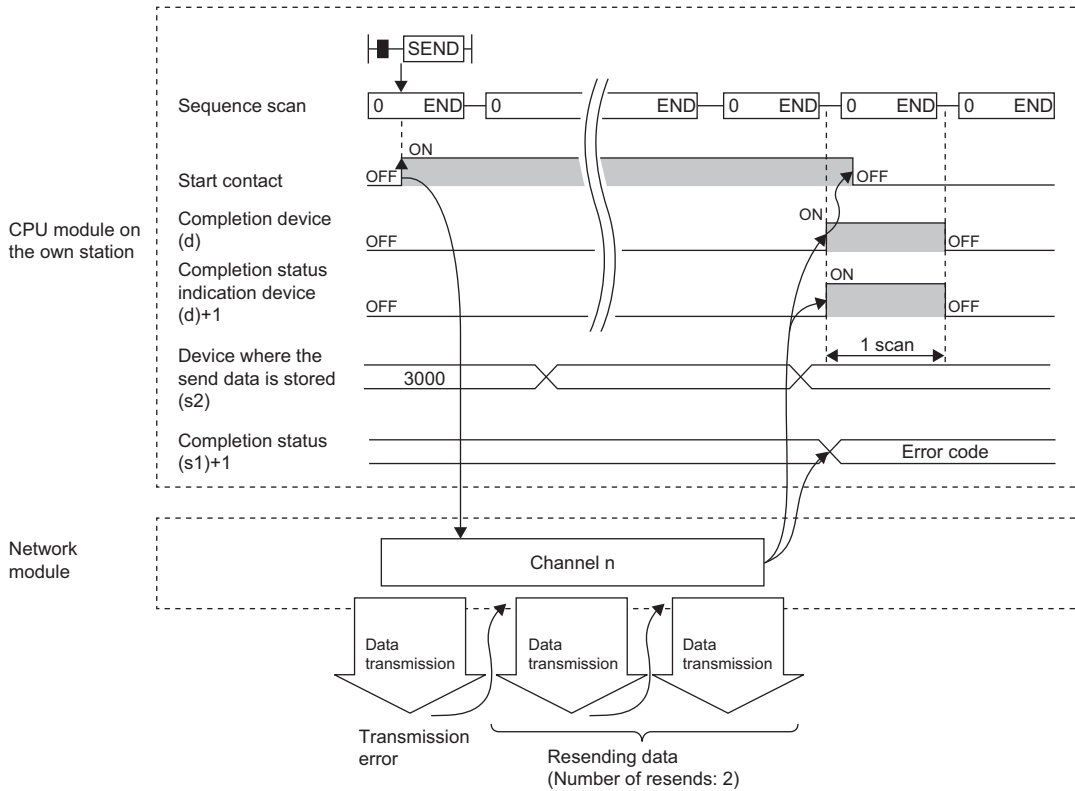

- Send processing is performed only once on the rising edge when the send command turns on.

Operation error

Error code ((s1)+1)	Description
4000H to 4FFFH	MELSEC iQ-R CPU Module User's Manual (Application)
C000H to CBFH	MELSEC iQ-R Ethernet User's Manual (Application) MELSEC iQ-R CC-Link IE TSN User's Manual (Application)
CFC0H to CFFFH	MELSEC iQ-R CPU Module User's Manual (Application) MELSEC iQ-R CC-Link IE TSN User's Manual (Application)
D000H to DFFFH	MELSEC iQ-R CC-Link IE Field Network User's Manual (Application) MELSEC iQ-R CC-Link IE TSN User's Manual (Application)
E000H to EFFFH	MELSEC iQ-R CC-Link IE Controller Network User's Manual (Application)
F000H to FFFFH	MELSEC iQ-R MELSECNET/H Network Module User's Manual (Application)

Receiving data from the programmable controller on another station

JP.RECV, GP.RECV



These instructions read the data received from the programmable controller of another station (for the main routine program).

Ladder	ST
	<pre>ENO:=JP_RECV(EN,J,s,d1,d2); ENO:=GP_RECV(EN,U,s,d1,d2);</pre>

FBD/LD

Execution condition

Instruction	Execution condition
JP.RECV GP.RECV	

Setting data

Description, range, data type

Operand	Description	Range	Data type	Data type (label)
(J/U)	JP.RECV (J): Own station network number GP.RECV (U): Start I/O number (first three digits in four-digit hexadecimal representation) of own station or own node	1 to 239 00H to FEH	16-bit unsigned binary 16-bit unsigned binary	ANY16 ANY16
(s)	Own station start device where control data is stored	Refer to the control data.	Device name	ANY16 ^{*1}
(d1)	Own station head device for storing the receive data (A continuous area for the receive data length is required.)	—	Device name	ANY16 ^{*1}
(d2)	Device of the own station, which turns on for one scan upon completion of the instruction. When the instruction completes with an error, (d2)+1 also turns on.	—	Bit	ANYBIT_ARRAY (Number of elements: 2)
EN	Execution condition	—	Bit	BOOL
ENO	Execution result	—	Bit	BOOL

*1 When specifying setting data by using a label, define an array to secure enough operation area and specify an element of the array label.

■Applicable devices

Operand		Bit		Word			Double word		Indirect specification	Constant			Others	
		X, Y, M, L, SM, F, B, SB, FX, FY	J□□	T, ST, C, D, W, SD, SW, FD, R, ZR, RD	U□\G□, J□\□, U3E□\□(H)G□	Z	LT, LST, LC	LZ		K, H	E	\$	J	U
(J/U)	JP.RECV	—	—	—	—	—	—	—	—	—	—	—	○	—
	GP.RECV	—	—	○	—	—	—	—	○	○	—	—	—	○
(s)		—	—	○ ^{*2}	—	—	—	—	○	—	—	—	—	—
(d1)		—	—	○ ^{*2}	—	—	—	—	○	—	—	—	—	—
(d2)		○ ^{*1}	—	○ ^{*3}	—	—	—	—	—	—	—	—	—	—

*1 FX and FY cannot be used.

*2 FD cannot be used.

*3 T, ST, C, and FD cannot be used.

Control data

Operand: (s)								
Device	Item	Description	Setting range	Set by				
+0	Error completion type	<p>b15 ... b7 ... b0</p> <table border="1" style="width: 100%; border-collapse: collapse;"> <tr> <td style="width: 25%; text-align: center;">(2)</td> <td style="width: 25%; text-align: center;">0</td> <td style="width: 25%; text-align: center;">(1)</td> <td style="width: 25%; text-align: center;">0</td> </tr> </table> <p>(1) Error completion type (bit 7) Specify whether to set clock data at completion with an error.</p> <ul style="list-style-type: none"> • 0: Clock data at error occurrence is not stored in (s1)+11 and later. • 1: Clock data at error occurrence is stored in (s1)+11 and later. <p>(2) Target station address display method (bit 15) (CC-Link IE TSN only)</p> <ul style="list-style-type: none"> • 0: Specify "network number" in (s1)+4, and specify "station number" in (s1)+5. • 1: Specify "IP address" in (s1)+4, 5. 	(2)	0	(1)	0	0000H 0080H 8000H 8080H	User
(2)	0	(1)	0					
+1	Completion status	<p>The completion status is stored upon completion of the instruction.</p> <ul style="list-style-type: none"> • 0: Normal • Other than 0: Error (error code) 	—	System				
+2	Own station channel	Specify the channel to be used by own station. (☞ Page 66 Range of available channels)	1 to 8, 11 to 18	User				
+3	Channel used by sending station	The channel number (1 to 8) used by the sending station is stored.	—	System				
+4	Sending station network number	<p>[Ethernet, CC-Link IE Controller Network, CC-Link IE Field Network, or MELSECNET/H] The network number (1 to 239) of the sending station is stored.</p> <p>[CC-Link IE TSN] ■When "0" is specified in bit 15 of (s1)+0 The network number (1 to 239) of the target station is stored. ■When "1" is specified in bit 15 of (s1)+0 The IP address (third and fourth octets) of the target station is stored.</p> <p>b15 ... b8 b7 ... b0</p> <table border="1" style="width: 100%; border-collapse: collapse;"> <tr> <td style="width: 50%;"></td> <td style="width: 50%;"></td> </tr> </table> <ul style="list-style-type: none"> • b8 to b15: 3rd octet • b0 to b7: 4th octet 			—	System		
+5	Sending station number	<p>[Ethernet or CC-Link IE Controller Network] The station number of the sending station is stored.</p> <ul style="list-style-type: none"> • 1 to 120: Station number (receiving from station number) <p>[CC-Link IE Field Network] The station number of the sending station is stored.</p> <ul style="list-style-type: none"> • 125: Master station • 1 to 120: Local station, intelligent device station, submaster station <p>[CC-Link IE TSN] ■When "0" is specified in bit 15 of (s1)+0 The station number of the sending station is stored.</p> <ul style="list-style-type: none"> • 1 to 120: Slave station • 125: Master station <p>■When "1" is specified in bit 15 of (s1)+0 The IP address (first and second octets) of the target station is stored.</p> <p>b15 ... b8 b7 ... b0</p> <table border="1" style="width: 100%; border-collapse: collapse;"> <tr> <td style="width: 50%;"></td> <td style="width: 50%;"></td> </tr> </table> <ul style="list-style-type: none"> • b8 to b15: 1st octet • b0 to b7: 2nd octet <p>[MELSECNET/H] The station number of the sending station is stored.</p> <ul style="list-style-type: none"> • 1 to 64: Station number 			—	System		
+6	Not used	—	—	—				
+7								

Operand: (s)						
Device	Item	Description	Setting range	Set by		
+8	Arrival monitoring time	[CC-Link IE TSN, CC-Link IE Controller Network, CC-Link IE Field Network, or MELSECNET/H] Specify the monitoring time until completion of processing. The instruction is completed with an error if it fails to complete within the monitoring time. • 0: 10s • 1 to 32767: 1 to 32767s	0 to 32767	User		
		[Ethernet] Specify the TCP resend timer value or greater for the monitoring time till completion of processing. The instruction is completed with an error if it fails to complete within the monitoring time. • 0 to (TCP resend timer value): The TCP resend timer value is assumed as the monitoring time. • (TCP resend timer value + 1) to 16383: (TCP resend timer value + 1) to 16383s	0 to 16383	User		
+9	Receive data length	The number of data received and stored in (d1) to (d1)+n is stored. • 0: No receive data • 1 to 960: Number of words of received data	0 to 960	System		
+10	Not used	—	—	—		
+11	Clock setting flag	The validity status (valid or invalid) of the data in (s)+12 and later is stored. Note that the data in (s)+12 and later is not cleared even when the instruction is completed successfully. • 0: Invalid • 1: Valid	—	System		
+12	Clock data (Set only in an abnormal state)	Upper 8 bits: Month (01H to 12H) Lower 8 bits: Lower 2 digits of year (00H to 99H)	—	System		
+13		Upper 8 bits: Hour (00H to 23H) Lower 8 bits: Day (01H to 31H)	—	System		
+14		Upper 8 bits: Second (00H to 59H) Lower 8 bits: Minute (00H to 59H)	—	System		
+15		Upper 8 bits: Year (00H to 99H: Upper two digits of the year) Lower 8 bits: Day of the week (00H (Sun.) to 06H (Sat.))	—	System		
+16		Error detection network number	<p>■When "0" is specified in bit 15 of (s1)+0 The network number of the station in which an error was detected is stored. (No information is stored if an error is detected in the own station.) • 1 to 239 (Network number)</p> <p>■When "1" is specified in bit 15 of (s1)+0 (CC-Link IE TSN only) The IP address (third and fourth octets) in which an error is detected is stored. (No information is stored if an error is detected in the own station.)</p> <p>b15 ... b8 b7 ... b0</p> <table border="1" style="width: 100%; border-collapse: collapse;"> <tr> <td style="width: 50%; height: 15px;"></td> <td style="width: 50%; height: 15px;"></td> </tr> </table> <p>• b8 to b15: 3rd octet • b0 to b7: 4th octet</p>			—
+17	Error-detected station number	<p>■When "0" is specified in bit 15 of (s1)+0 The station number of the station where an error was detected is stored. (No information is stored if an error is detected in the own station.) [Ethernet or CC-Link IE Controller Network] • 1 to 120: Station number [CC-Link IE Field Network] • 125: Master station • 1 to 120: Local station, intelligent device station, submaster station [CC-Link IE TSN] • 125: Master station • 1 to 120: Slave station [MELSECNET/H] • 1 to 64: Station number</p> <p>■When "1" is specified in bit 15 of (s1)+0 (CC-Link IE TSN only) The IP address (first and second octets) of the station where an error was detected is stored. (No information is stored if an error is detected in the own station.)</p> <p>b15 ... b8 b7 ... b0</p> <table border="1" style="width: 100%; border-collapse: collapse;"> <tr> <td style="width: 50%; height: 15px;"></td> <td style="width: 50%; height: 15px;"></td> </tr> </table> <p>• b8 to b15: 1st octet • b0 to b7: 2nd octet</p>			—	System

- The continuous area (a maximum of 960 words) for the receive data length ((s)+9) is required in the receive data storage device (d1).
- The RECV instruction is executed each time the bit of the relevant channel in the RECV instruction request area (address 205) in the buffer memory is set to ON (received data exists).
- When multiple network modules with the same network number are mounted in the own station, Specify "U" (start I/O number) to execute the RECV instruction. The RECV instruction cannot be executed by specifying "J" (network number).

(Example: When executing the GP.RECV instruction in station number 3 with regard to the SEND instruction from station number 2, specify "U2".)

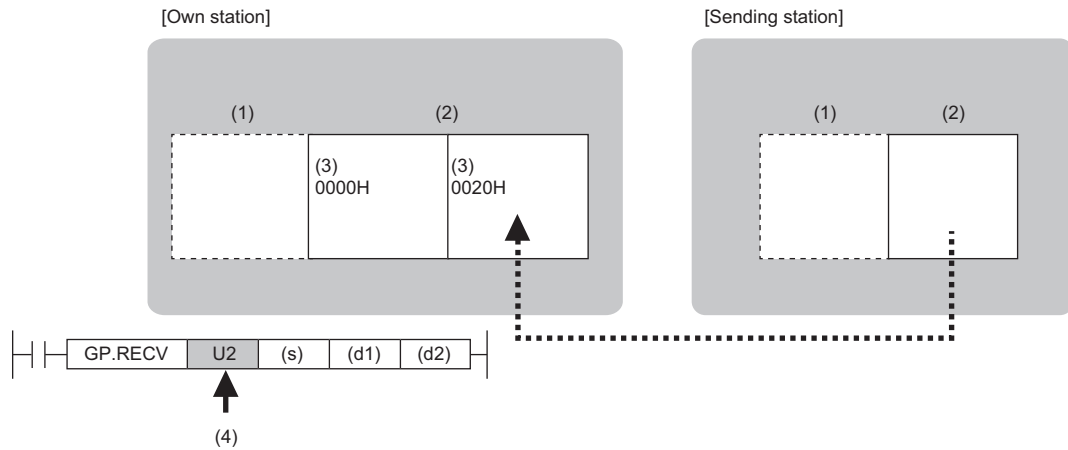

- (1) CPU module
- (2) Network module
- (3) Start I/O number
- (4) Specify U (start I/O number)

Processing details

- These instructions read the data sent from the station connected to the target station specified by the network number and station number of control data from the module of the own station. Upon completion of reading the received data from the network module, the completion device specified by (d2) turns on.
- For the target stations that can be specified, refer to the following.

Page 65 Target networks and target station types

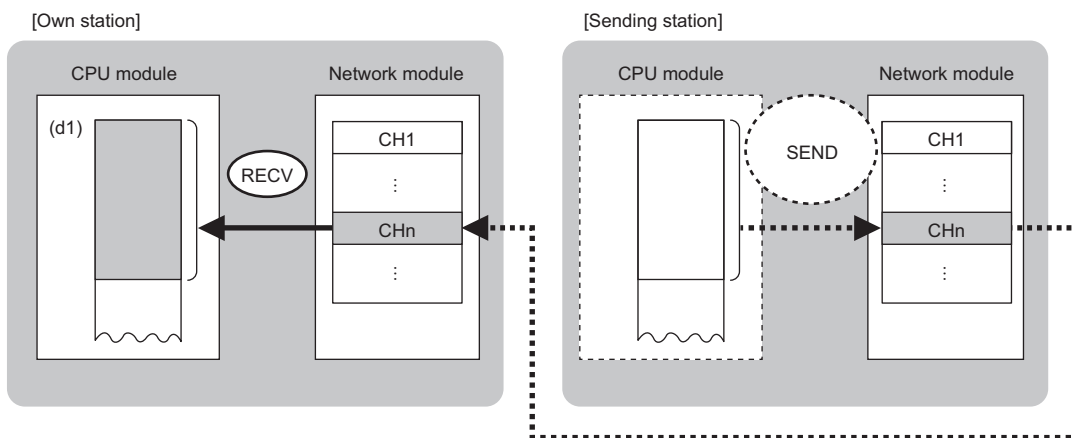

CH: Channel

- The SEND instruction is executed to send data. The data received from the sending station is stored in the own station channel specified by the sending station and the corresponding bit in the RECV instruction execution request area for each network module is set to ON. When the corresponding bit in the RECV instruction execution request area is set to ON, the received data is read from the receive data storage channel. The following table lists the RECV instruction execution request areas for individual networks.

Network	Name of RECV instruction execution request area	Device number/address of corresponding bit
CC-Link IE TSN CC-Link IE Field Network CC-Link IE Controller Network	RECV instruction channel 1 execution request flag	SB0030
	RECV instruction channel 2 execution request flag	SB0031
	RECV instruction channel 3 execution request flag	SB0032
	RECV instruction channel 4 execution request flag	SB0033
	RECV instruction channel 5 execution request flag	SB0034
	RECV instruction channel 6 execution request flag	SB0035
	RECV instruction channel 7 execution request flag	SB0036
	RECV instruction channel 8 execution request flag	SB0037
MELSECNET/H	Instruction channel 1 execution request flag	SB00A0
	Instruction channel 2 execution request flag	SB00A1
	Instruction channel 3 execution request flag	SB00A2
	Instruction channel 4 execution request flag	SB00A3
	Instruction channel 5 execution request flag	SB00A4
	Instruction channel 6 execution request flag	SB00A5
	Instruction channel 7 execution request flag	SB00A6
	Instruction channel 8 execution request flag	SB00A7
Ethernet (Q series compatible)	RECV instruction execution request area	Buffer memory address 205 (CDH) bit 0
		Buffer memory address 205 (CDH) bit 1
		Buffer memory address 205 (CDH) bit 2
		Buffer memory address 205 (CDH) bit 3
		Buffer memory address 205 (CDH) bit 4
		Buffer memory address 205 (CDH) bit 5
		Buffer memory address 205 (CDH) bit 6
		Buffer memory address 205 (CDH) bit 7
Ethernet*1	RECV instruction execution request area	Buffer memory address 5301 (14B5H) bit 0
		Buffer memory address 5301 (14B5H) bit 1
		Buffer memory address 5301 (14B5H) bit 2
		Buffer memory address 5301 (14B5H) bit 3
		Buffer memory address 5301 (14B5H) bit 4
		Buffer memory address 5301 (14B5H) bit 6
		Buffer memory address 5301 (14B5H) bit 7

*1 When the network type of the Ethernet module is "Ethernet", the buffer memory address of PORT2 is increased by 2000000.

 MELSEC iQ-R Ethernet User's Manual (Application)

- When executing multiple link dedicated instructions concurrently, be careful not to overlap the channels of the link dedicated instructions. Multiple link dedicated instructions specifying the same channel cannot be used concurrently.
- When the RECV instruction is used to read receive data from the same channel, the RECVS instruction (for use in interrupt programs) cannot be used in combination.
- The execution status and the completion status of the RECV instruction can be checked with the completion device (d2) and the completion status indication device (d2)+1.

- Completion device (d2)

This device turns on during END processing of the scan where the RECV instruction completes, and turns off during the next END processing.

- Completion status indication device (d2)+1

This device turns on or off depending on the completion status of the RECV instruction.

When completed successfully: The device remains off.

When completed with an error: The device turns on during END processing of the scan where the RECV instruction completes, and turns off during the next END processing.

• The following figure shows the execution timing of the RECV instruction.

• When completed successfully

For the execution timing, refer to the following instructions.

☞ Page 111 JP.SEND, GP.SEND

• When completed with an error

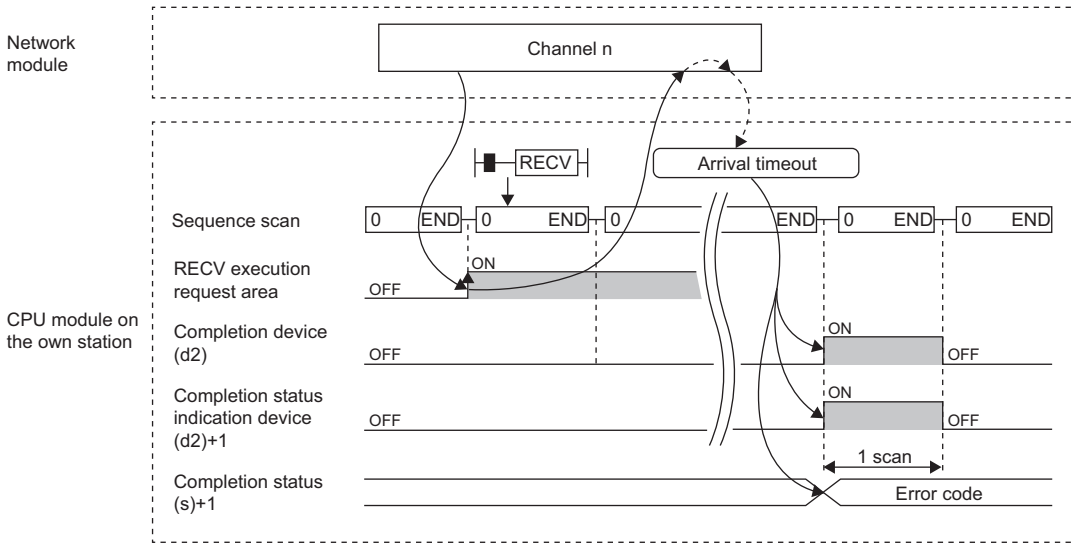

• Read processing is performed only once on the rising edge when the read command turns on.

Operation error

Error code ((s)+1)	Description
C000H to CFBFH	<ul style="list-style-type: none"> MELSEC iQ-R Ethernet User's Manual (Application) MELSEC iQ-R CC-Link IE TSN User's Manual (Application)
CFC0H to CFFFH	<ul style="list-style-type: none"> MELSEC iQ-R CPU Module User's Manual (Application) MELSEC iQ-R CC-Link IE TSN User's Manual (Application)
D000H to DFFFH	<ul style="list-style-type: none"> MELSEC iQ-R CC-Link IE Field Network User's Manual (Application) MELSEC iQ-R CC-Link IE TSN User's Manual (Application)
E000H to EFFFH	<ul style="list-style-type: none"> MELSEC iQ-R CC-Link IE Controller Network User's Manual (Application)
F000H to FFFFH	<ul style="list-style-type: none"> MELSEC iQ-R MELSECNET/H Network Module User's Manual (Application)

Receiving data from the programmable controller on another station (for interrupt programs)

G.RECVS, Z.RECVS



These instructions read the data received from the programmable controller of another station (for interrupt programs).

Ladder	ST
	<pre>ENO:=G_RECVS(EN,U,s,d1,d2); ENO:=Z_RECVS(EN,U,s,d1,d2);</pre>

FBD/LD

Execution condition

Instruction	Execution condition
G.RECVS Z.RECVS	

Setting data

Description, range, data type

Operand	Description	Range	Data type	Data type (label)
(U)	G.RECVS Start I/O number (first three digits in four-digit hexadecimal representation) of own station or own node	00H to FEH	16-bit unsigned binary	ANY16
	Z.RECVS Start I/O number (first three digits in four-digit hexadecimal representation) of own station or own node	00H to FEH	String	ANY16_OR_STRING_SINGLE
(s)	Own station start device where control data is stored	Refer to the control data.	Device name	ANY16 ^{*1}
(d1)	Own station head device for storing the receive data (A continuous area for the receive data length is required.)	—	Device name	ANY16 ^{*1}
(d2)	Dummy	—	Bit	ANYBIT_ARRAY (Number of elements: 2)
EN	Execution condition	—	Bit	BOOL
ENO	Execution result	—	Bit	BOOL

*1 When specifying setting data by using a label, define an array to secure enough operation area and specify an element of the array label.

■Applicable devices

Operand	Bit		Word			Double word		Indirect specification	Constant			Others (U)
	X, Y, M, L, SM, F, B, SB, FX, FY	J□\□	T, ST, C, D, W, SD, SW, FD, R, ZR, RD	U□\G□, J□\□, U3E□(H)G□	Z	LT, LST, LC	LZ		K, H	E	\$	
(U)	G.RECVS	—	—	○	—	—	—	○	○	—	—	○
	Z.RECVS	—	—	○	—	—	—	○	—	—	○	○
(s)		—	—	○*2	—	—	—	○	—	—	—	—
(d1)		—	—	○*2	—	—	—	○	—	—	—	—
(d2)		○*1	—	○*3	—	—	—	—	—	—	—	—

*1 FX and FY cannot be used.

*2 FD cannot be used.

*3 T, ST, C, and FD cannot be used.

■Control data

Operand: (s)				
Device	Item	Description	Setting range	Set by
+0	System area	—	—	—
+1	Completion status	The completion status is stored upon completion of the instruction. • 0: Normal • Other than 0: Error (error code)	—	System
+2	Own station channel	Specify the channel to be used by own station. (☞ Page 66 Range of available channels)	—	User
+3	Channel used by sending station	The channel number (1 to 8) used by the sending station is stored.	—	System
+4	Sending station network number	The network number (1 to 239) of the sending station is stored.	—	System
+5	Sending station number	The station number of the sending station is stored. [Ethernet or CC-Link IE Controller Network] • 1 to 120: Station number (receiving from station number) [CC-Link IE Field Network] • 125: Master station • 1 to 120: Local station, intelligent device station, submaster station [MELSECNET/H] The station number of the sending station is stored. • 1 to 64: Station number	—	System
+6 to +8	System area	—	—	—
+9	Receive data length	The number of data received and stored in (d1)+0 to (d1)+□ is stored. • 0: No receive data • 1 to 960: Number of words of received data	0 to 960	System

■Receive data

Operand: (d1)				
Device	Item	Description	Setting range	Set by
+0 to +□	Receive data	Receive data is stored.	—	System



The continuous area (a maximum of 960 words) for the receive data length ((s)+9) is required in the receive data storage device (d1).

Processing details

- These instructions read the receive data of the target station sent to (s)+2 (own station storage channel) of control data.
- For the target stations that can be specified, refer to the following.

☞ Page 65 Target networks and target station types

- The SEND instruction is executed to send data. The data received from the sending station is stored in the own station channel specified by the sending station, and the interrupt program with the interrupt number specified by the engineering tool starts. The RECVS instruction is used in this interrupt program to read receive data.

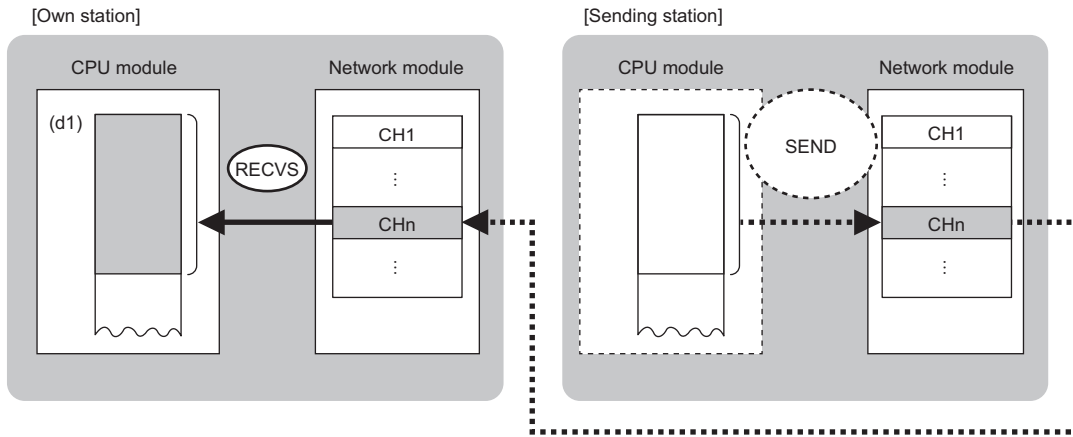

CH: Channel

• The following figure shows the execution timing of the RECVS instruction.

• When completed successfully

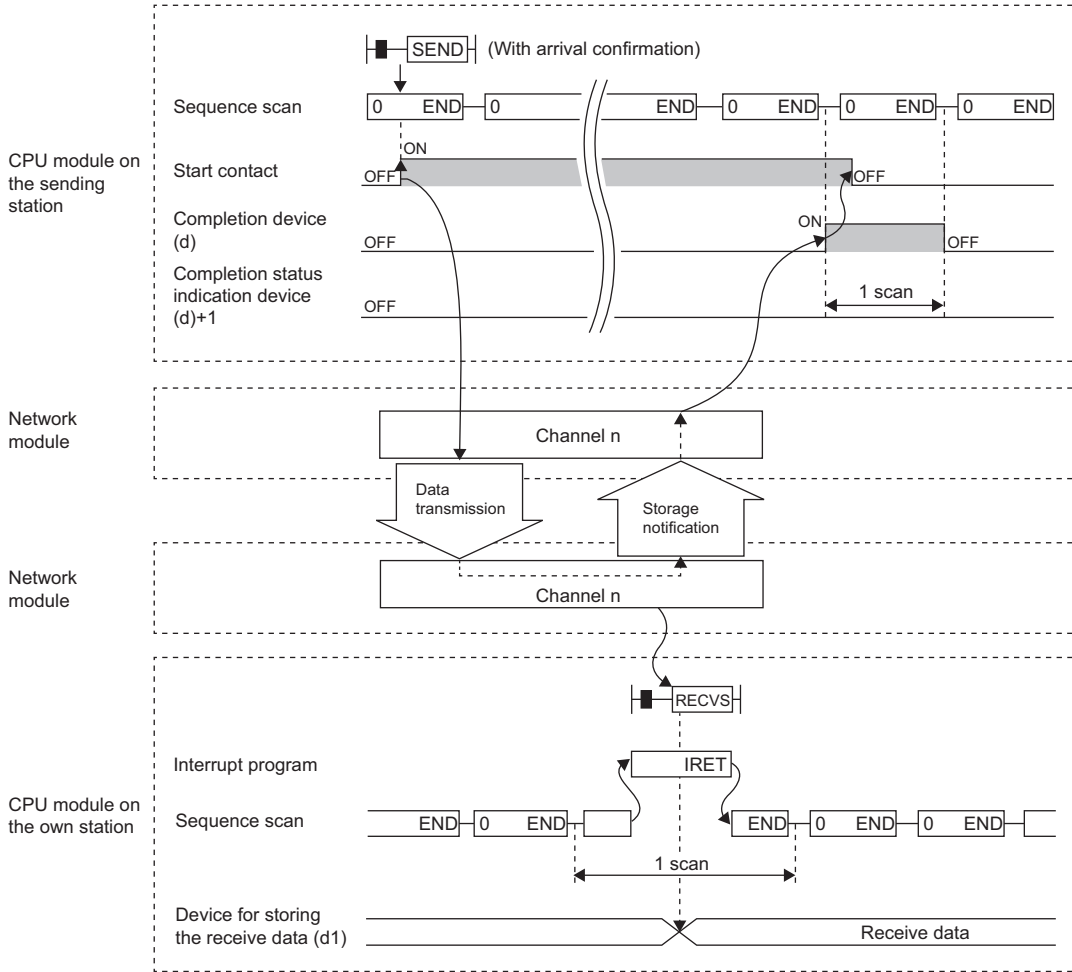



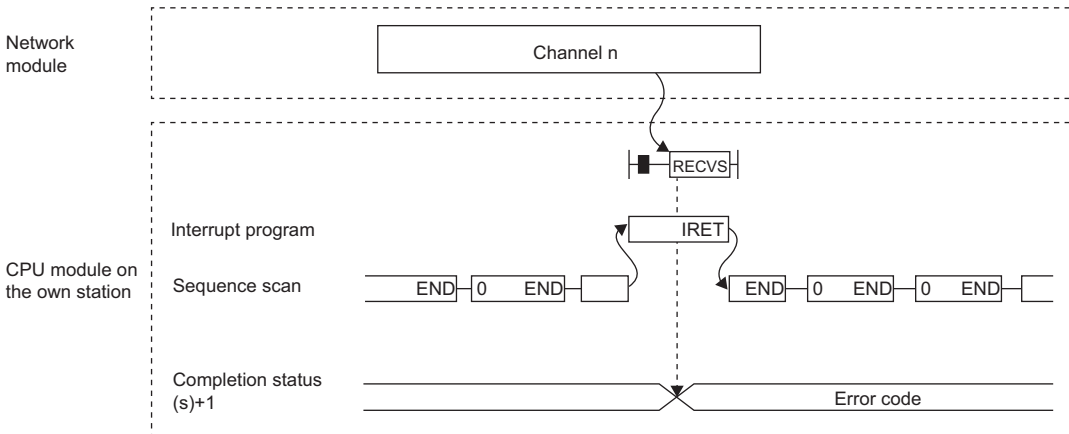

• When completed with an error



• The RECVS instruction is used in interrupt programs and processing is completed in a single scan.

• When the RECVS instruction is used to read receive data from the same channel, the RECV instruction (for use in the main program) cannot be used in combination.

Operation error

Error code ((s)+1)	Description
C000H to CFBFH	 MELSEC iQ-R Ethernet User's Manual (Application)
CFC0H to CFFFH	 MELSEC iQ-R CPU Module User's Manual (Application)
D000H to DFFFH	 MELSEC iQ-R CC-Link IE Field Network User's Manual (Application)
E000H to EFFFH	 MELSEC iQ-R CC-Link IE Controller Network User's Manual (Application)
F000H to FFFFH	 MELSEC iQ-R MELSECNET/H Network Module User's Manual (Application)

Reading data from the programmable controller (Q series-compatible)

J(P).ZNRD

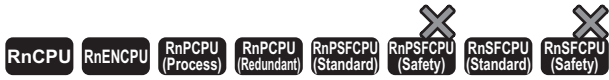

These instructions read data in units of words from a device in the programmable controller (MELSEC-A/QnA/Q/L series) of another station.

Ladder	ST
	<pre>ENO:=J_ZNRD(EN,J,s1,s2,n,d1,d2); ENO:=JP_ZNRD(EN,J,s1,s2,n,d1,d2);</pre>

FBD/LD

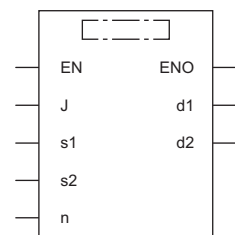

■ Execution condition

Instruction	Execution condition
J.ZNRD	
JP.ZNRD	

Setting data

■Description, range, and data type

Operand	Description	Range	Data type	Data type (label)
(J)	Target station network number	1 to 239	16-bit unsigned binary	ANY16
(s1)	Target station number	1 to 64	16-bit unsigned binary	ANY16
(s2)	Target station start device where the data to be read is stored	—	String* ¹	ANYSTRING_SINGLE* ¹
(d1)	Own station start device for storing the read data (A continuous area for the read data length is required.)	—	Device name	ANY16* ²
(n)	Read data length	■When the target station is AnUCPU/QnACPU/QCPU/LCPU 1 to 230 ■When the target station is a MELSEC-A series CPU module other than AnUCPU 1 to 32	16-bit unsigned binary	ANY16
(d2)	Device of the own station, which turns on for one scan upon completion of the instruction. When the instruction completes with an error, (d2)+1 also turns on.	—	Bit	ANYBIT_ARRAY (Number of elements: 2)
EN	Execution condition	—	Bit	BOOL
ENO	Execution result	—	Bit	BOOL

*1 For the specifications of the string data to be specified, refer to the following.

 Page 70 Specifications of character string data specified by link dedicated instructions

*2 When specifying setting data by using a label, define an array to secure enough operation area and specify an element of the array label.

■Applicable devices

Operand	Bit		Word				Double word		Indirect specification	Constant			Others (J)
	X, Y, M, L, SM, F, B, SB, FX, FY	J□\□	T, ST, C, D, W, SD, SW, FD, R, ZR, RD	U□\G□, J□\□, U3E□\□(H)G□	Z	LT, LST, LC	LZ	K, H, E, \$					
(J)	—	—	—	—	—	—	—	—	—	—	—	—	○
(s1)	○* ¹	—	○* ²	—	—	—	—	○	—	—	—	—	—
(s2)	—	—	—	—	—	—	—	—	—	—	○	—	—
(d1)	—	—	○* ²	—	—	—	—	○	—	—	—	—	—
(n)	○* ¹	—	○* ²	—	—	—	—	○	—	—	—	—	—
(d2)	○* ¹	—	○* ³	—	—	—	—	—	—	—	—	—	—

*1 FX and FY cannot be used.

*2 FD cannot be used.

*3 T, ST, C, and FD cannot be used.

Point

The J(P).ZNRD instruction is executed using the following fixed values in addition to setting data.

- Arrival monitoring time: 10s
- Number of resends: 5

Processing details

- These instructions read the data from the specified word device in the target station specified by the target network number (J) and target station number (s1). Upon completion of reading the device data, the completion device specified by (d2) turns on.
- For the target stations that can be specified, refer to the following.

☞ Page 65 Target networks and target station types

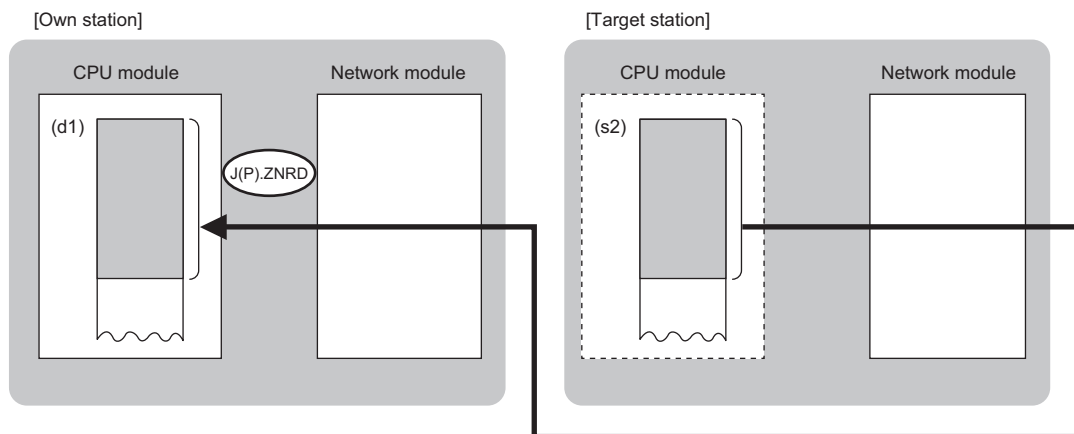

Point

- The J(P).ZNRD instruction cannot be executed for RCPU. If executed, error code 4001H is stored in the completion status and the instruction is completed with an error.
- The J(P).ZNRD instruction is an instruction (Q series compatible instruction) for replacement of the equivalent instruction used in the programs running on the MELSEC-Q series. When creating a new program, use the READ instruction.

- Device data can be read also from stations connected to networks other than the stations connected to the own station network.
- The execution status and the completion status of the J(P).ZNRD instruction can be checked with the completion device (d2) and the completion status indication device (d2)+1.

- Completion device (d2)

This device turns on during END processing of the scan where the J(P).ZNRD instruction completes, and turns off during the next END processing.

- Completion status indication device (d2)+1

This device turns on or off depending on the completion status of the J(P).ZNRD instruction.

When completed successfully: The device remains off.

When completed with an error: The device turns on during END processing of the scan where the J(P).ZNRD instruction completes, and turns off during the next END processing.

• The following figure shows the execution timing of the J(P).ZNRD instruction.

• When completed successfully

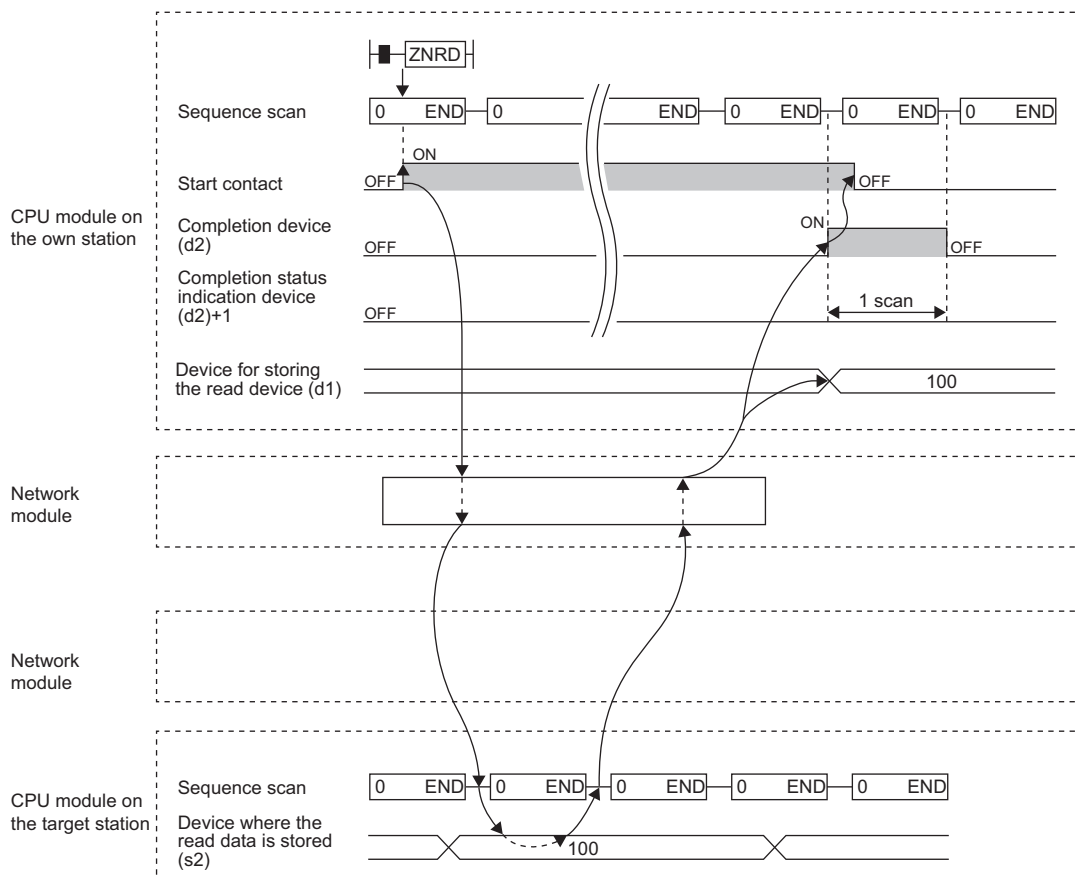

• When completed with an error

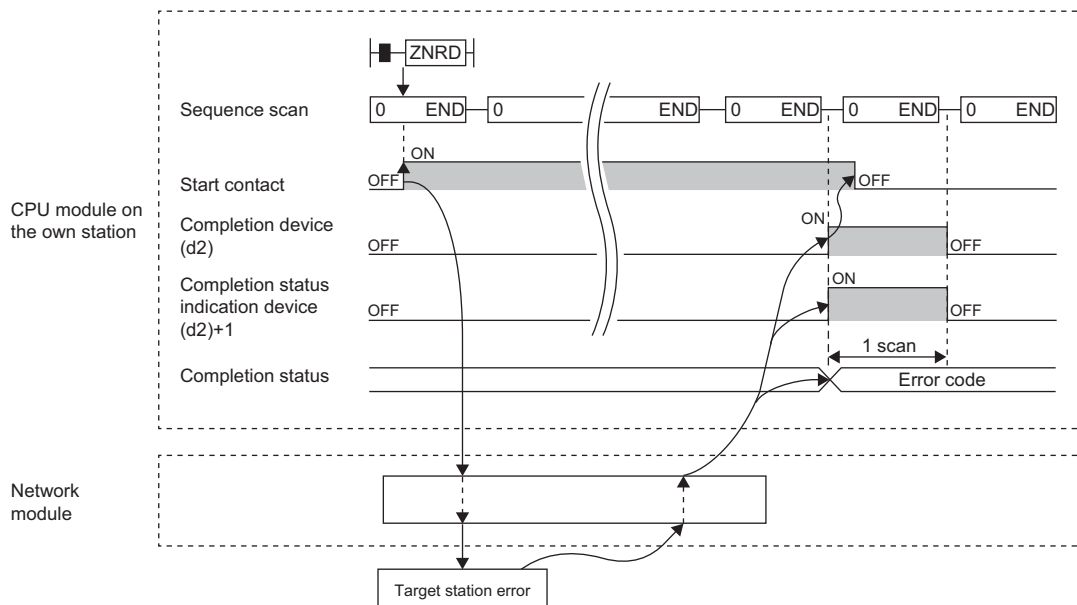

The completion status is stored in the special register (SW) when the CC-Link IE Controller Network is used, in the buffer memory when Ethernet is used, or in the special register (SW0031) when the MELSECNET/H is used.

• When the JP.ZNRD instruction is executed, read processing is performed only once on the rising edge when the read command turns on.

Precautions





The J(P).ZNRD instruction cannot be executed when the CPU module on the target station is one of the following:

- AnUCPU with the version AX (manufactured in July 1995) or earlier
- A2ASCPU(-S1) with the version CN (manufactured in July 1995) or earlier

If executed, the dedicated instruction response timer causes a timeout in the instruction start source and the J(P).ZNRD instruction is completed with an error. If the dedicated instruction response timer causes a timeout, use a CPU module satisfying one of the following versions.

- AnUCPU with the version AY (manufactured in July 1995) or later
- A2ASCPU(-S1) with the version CP (manufactured in July 1995) or later

Operation error

Error code*4	Description
4000H to 4FFFH	 MELSEC iQ-R CPU Module User's Manual (Application)
C000H to CFBFH	 MELSEC iQ-R Ethernet User's Manual (Application)
CFC0H to CFFFH	 MELSEC iQ-R CPU Module User's Manual (Application)
E000H to EFFFH	 MELSEC iQ-R CC-Link IE Controller Network User's Manual (Application)
F000H to FFFFH	 MELSEC iQ-R MELSECNET/H Network Module User's Manual (Application)

*4 The completion status in which an error code is stored is as follows.

CC-Link IE Controller Network: SW003A

Ethernet: Buffer memory address 5323 (14CBH)

MELSECNET/H: SW0031

Writing data to the programmable controller (Q series-compatible)

J(P).ZNWR



These instructions write data in units of words to a device in the programmable controller (MELSEC-A/QnA/Q/L series) of another station.

Ladder	ST
	<pre>ENO:=J_ZNWR(EN,J,s1,s2,n,d1,d2); ENO:=JP_ZNWR(EN,J,s1,s2,n,d1,d2);</pre>

FBD/LD

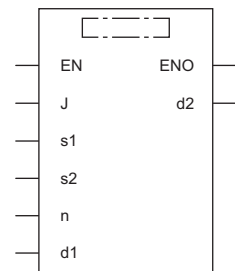

Execution condition

Instruction	Execution condition
J.ZNWR	
JP.ZNWR	

Setting data

■Description, range, and data type

Operand	Description	Range	Data type	Data type (label)
(J)	Target station network number	1 to 239	16-bit unsigned binary	ANY16
(s1)	Target station number	<ul style="list-style-type: none"> ■Station number specification 1 to 64: Station number station ■Group specification 0081H to 00A0H: All stations with group numbers 1 to 32 ■All-station specification 00FFH: All stations of target network number 	16-bit unsigned binary	ANY16
(d1)	Target station start device where data is to be written (A continuous area for the write data length is required.)	—	String ^{*1}	ANYSTRING_SINGLE ^{*1}
(s2)	Own station start device where write data is stored	—	Device name	ANY16 ^{*2}
(n)	Write data length	<ul style="list-style-type: none"> ■When the target station is AnUCPU/QnACPU/QCPU/LCPU 1 to 230 ■When the target station is a MELSEC-A series CPU module other than AnUCPU 1 to 32 	16-bit unsigned binary	ANY16
(d2)	Device of the own station, which turns on for one scan upon completion of the instruction. When the instruction completes with an error, (d2)+1 also turns on.	—	Bit	ANYBIT_ARRAY (Number of elements: 2)
EN	Execution condition	—	Bit	BOOL
ENO	Execution result	—	Bit	BOOL

*1 For the specifications of the string data to be specified, refer to the following.

☞ Page 70 Specifications of character string data specified by link dedicated instructions

*2 When specifying setting data by using a label, define an array to secure enough operation area and specify an element of the array label.

■Applicable devices

Operand	Bit		Word			Double word		Indirect specification	Constant			Others (J)
	X, Y, M, L, SM, F, B, SB, FX, FY	J□□	T, ST, C, D, W, SD, SW, FD, R, ZR, RD	U□□G□, J□□□, U3E□(H)G□	Z	LT, LST, LC	LZ		K, H, E, \$			
(J)	—	—	—	—	—	—	—	—	—	—	—	○
(s1)	○ ^{*1}	—	○ ^{*2}	—	—	—	○	—	—	—	—	—
(d1)	—	—	—	—	—	—	—	—	—	○	—	—
(s2)	—	—	○ ^{*2}	—	—	—	○	—	—	—	—	—
(n)	○ ^{*1}	—	○ ^{*2}	—	—	—	○	—	—	—	—	—
(d2)	○ ^{*1}	—	○ ^{*3}	—	—	—	—	—	—	—	—	—

*1 FX and FY cannot be used.

*2 FD cannot be used.

*3 T, ST, C, and FD cannot be used.

Point

The J(P).ZNWR instruction is executed using the following fixed values in addition to setting data.

- Arrival monitoring time: 10s
- Number of resends: 5

Processing details

- These instructions write the data in the device/label specified by (s2) in the own station to the word device in the target station specified by the target network number and target station number of the control data. Upon completion of writing device data to another station number, the completion device specified by (d2) turns on.
- For the target stations that can be specified, refer to the following.

☞ Page 65 Target networks and target station types

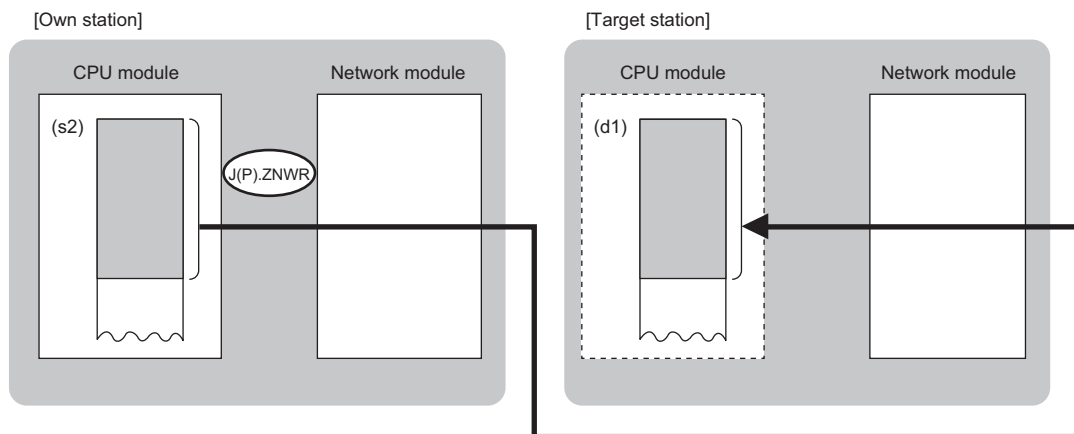

Point

- The J(P).ZNWR instruction cannot be executed for RCPU. If executed, error code 4001H is stored in the completion status and the instruction is completed with an error.
- The J(P).ZNWR instruction is an instruction (Q series compatible instruction) for replacement of the equivalent instruction used in the programs running on the MELSEC-Q series. When creating a new program, use the WRITE instruction.

- Device data can be written also to stations connected to networks other than the stations connected to the own station network.
- The execution status and the completion status of the J(P).ZNWR instruction can be checked with the completion device (d2) and the completion status indication device (d2)+1.

- Completion device (d2)

This device turns on during END processing of the scan where the J(P).ZNWR instruction completes, and turns off during the next END processing.

- Completion status indication device (d2)+1

This device turns on or off depending on the completion status of the J(P).ZNWR instruction.

When completed successfully: The device remains off.

When completed with an error: The device turns on during END processing of the scan where the J(P).ZNWR instruction completes, and turns off during the next END processing.

• The following figure shows the execution timing of the J(P).ZNWR instruction.

• When completed successfully

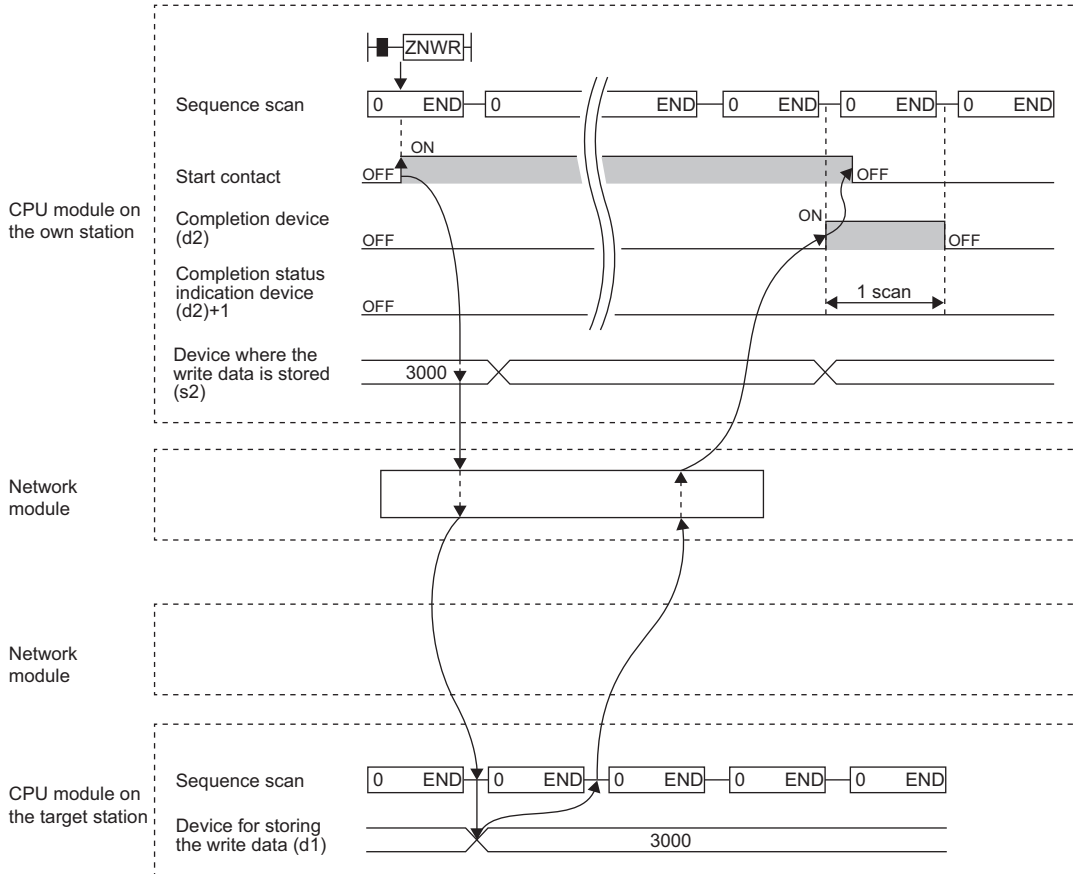

• When completed with an error

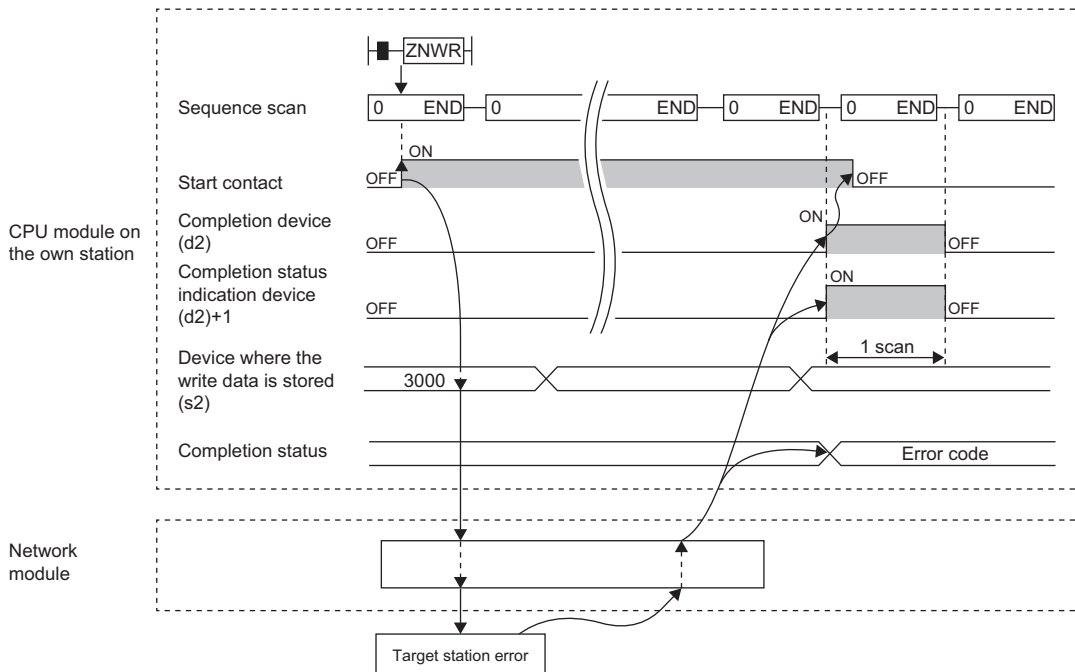

The completion status is stored in the special register (SW) when the CC-Link IE Controller Network is used, in the buffer memory when Ethernet is used, or in the special register (SW0033) when the MELSECNET/H is used.

• When the J.ZNWR instruction is used for execution, one complete cycle of write processing is followed by another while the write command is on. When the JP.ZNWR instruction is executed, write processing is performed only once on the rising edge when the write command turns on.

Precautions





The J(P).ZNWR instruction cannot be executed for the following CPU modules.

- AnUCPU with the version AX (manufactured in July 1995) or earlier
- A2ASCPU(-S1) with the version CN (manufactured in July 1995) or earlier

If executed, the dedicated instruction response timer causes a timeout in the instruction start source and the J(P).ZNWR instruction is completed with an error. If the dedicated instruction response timer causes a timeout, use a CPU module satisfying one of the following versions.

- AnUCPU with the version AY (manufactured in July 1995) or later
- A2ASCPU(-S1) with the version CP (manufactured in July 1995) or later

Operation error

Error code*4	Description
4000H to 4FFFH	 MELSEC iQ-R CPU Module User's Manual (Application)
C000H to CBFH	 MELSEC iQ-R Ethernet User's Manual (Application)
CFC0H to CFFFH	 MELSEC iQ-R CPU Module User's Manual (Application)
E000H to EFFFH	 MELSEC iQ-R CC-Link IE Controller Network User's Manual (Application)
F000H to FFFFH	 MELSEC iQ-R MELSECNET/H Network Module User's Manual (Application)

*4 The completion status in which an error code is stored is as follows.

CC-Link IE Controller Network: SW003B

Ethernet: Buffer memory address 5325 (14CDH)

MELSECNET/H: SW0033

Remote RUN/STOP

J(P).REQ, G(P).REQ

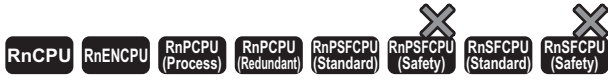

These instructions execute remote RUN or STOP for the programmable controller of another station.

Ladder	ST
	<pre>ENO:=J_REQ(EN,J,s1,s2,d1,d2); ENO:=JP_REQ(EN,J,s1,s2,d1,d2); ENO:=G_REQ(EN,U,s1,s2,d1,d2); ENO:=GP_REQ(EN,U,s1,s2,d1,d2);</pre>

FBD/LD

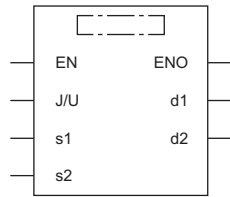

Execution condition

Instruction	Execution condition
J.REQ G.REQ	
JP.REQ GP.REQ	

Setting data

Description, range, data type

Operand	Description	Range	Data type	Data type (label)
(J/U)	J(P).REQ (J): Own station network number	1 to 239	16-bit unsigned binary	ANY16
	G(P).REQ (U): Start I/O number (first three digits in four-digit hexadecimal representation) of own station or own node	00H to FEH	16-bit unsigned binary	ANY16
(s1)	Own station start device where control data is stored	Refer to the control data.	Device name	ANY16 ^{*1}
(s2)	Own station start device where request data is stored	—	Device name	ANY16 ^{*1}
(d1)	Own station start device for storing response data	—	Device name	ANY16 ^{*1}
(d2)	Device of the own station, which turns on for one scan upon completion of the instruction. When the instruction completes with an error, (d2)+1 also turns on.	—	Bit	ANYBIT_ARRAY (Number of elements: 2)
EN	Execution condition	—	Bit	BOOL
ENO	Execution result	—	Bit	BOOL

*1 When specifying setting data by using a label, define an array to secure enough operation area and specify an element of the array label.

■Applicable devices

Operand		Bit		Word			Double word		Indirect specification	Constant			Others	
		X, Y, M, L, SM, F, B, SB, FX, FY	J□□	T, ST, C, D, W, SD, SW, FD, R, ZR, RD	U□□G□, J□□□, U3E□□(H)G□	Z	LT, LST, LC	LZ		K, H, E, \$	J, U			
(J/U)	J(P).REQ	—	—	—	—	—	—	—	—	—	—	—	○	—
	G(P).REQ	—	—	○	—	—	—	—	○	○	—	—	—	○
(s1)		—	—	○*2	—	—	—	—	○	—	—	—	—	—
(s2)		—	—	○*2	—	—	—	—	○	—	—	—	—	—
(d1)		—	—	○*2	—	—	—	—	○	—	—	—	—	—
(d2)		○*1	—	○*3	—	—	—	—	—	—	—	—	—	—

*1 FX and FY cannot be used.

*2 FD cannot be used.

*3 T, ST, C, and FD cannot be used.



The REQ instruction cannot be executed when the target station is ACPU.

■Control data

Operand: (s1)				
Device	Item	Description	Setting range	Set by
+0	Error completion type	b15 ... b7 ... b4 ... b0 (2) 0 (1) 0 1 0 1 (1) Error completion type (bit 7) Specify whether to set data at completion with an error. • 0: Do not set data in (s1)+11 and later at completion with an error. • 1: Set data in (s1)+11 and later at completion with an error. (2) Target station address specification method (bit 15) (CC-Link IE TSN only) • 0: Specify "network number" in (s1)+4, and specify "station number" in (s1)+5. • 1: Specify "IP address" in (s1)+4, 5.	0011H 0091H 8011H 8091H	User
+1	Completion status	The completion status is stored upon completion of the instruction. • 0: Normal • Other than 0: Error (error code)	—	System
+2	Own station channel	Specify the channel to be used by own station. (☞ Page 66 Range of available channels)	1 to 8, 11 to 18	User
+3	Target station CPU type	Specify the CPU type of the target station. • 0000H: Addressed to target station CPU (control CPU) • 03D0H: Addressed to control system CPU • 03D1H: Addressed to standby system CPU • 03D2H: Addressed to system A CPU • 03D3H: Addressed to system B CPU • 03E0H: Addressed to multiple CPU No.1 • 03E1H: Addressed to multiple CPU No.2 • 03E2H: Addressed to multiple CPU No.3 • 03E3H: Addressed to multiple CPU No.4 • 03FFH: Addressed to target station CPU (control CPU)	0000H 03D0H to 03D3H 03E0H to 03E3H 03FFH	User

Operand: (s1)						
Device	Item	Description	Setting range	Set by		
+4	Target network number	<p>[Ethernet, CC-Link IE Controller Network, CC-Link IE Field Network, or MELSECNET/H] Specify the network number of the target station.</p> <ul style="list-style-type: none"> • 1 to 239: Network number <p>[CC-Link IE TSN] ■When "0" is specified in bit 15 of (s1)+0 Specify the network number (1 to 239) of the target station. ■When "1" is specified in bit 15 of (s1)+0 Specify the IP address (third and fourth octets) of the target station.</p> <p>b15 ... b8 b7 ... b0</p> <table border="1" style="width: 100%; border-collapse: collapse;"> <tr> <td style="width: 50%; height: 15px;"></td> <td style="width: 50%; height: 15px;"></td> </tr> </table> <ul style="list-style-type: none"> • b8 to b15: 3rd octet • b0 to b7: 4th octet 			<ul style="list-style-type: none"> ■(s1)+4 • Network number: 1 to 239 ■(s1)+5 • Station number: 1 to 120, 125, 126 • Group number: 0081H to 00A0H • All-station specification: 00FFH ■(s1)+4, 5 • IP address: 0000001H to FFFFFFFEH 	User
+5	Target station number	<p>[Ethernet or CC-Link IE Controller Network] Specify the station number of the target station.</p> <p>(1) Station number specification</p> <ul style="list-style-type: none"> • 1 to 120: Station number <p>(2) Group number specification</p> <ul style="list-style-type: none"> • 0081H to 00A0H: All stations with group numbers 0001H to 0020H (Can be specified for remote RUN/STOP) <p>(3) All-station specification</p> <ul style="list-style-type: none"> • 00FFH: All stations of target network number (broadcast (excluding the own station)) (Can be specified for remote RUN/STOP) <p>[CC-Link IE Field Network] Specify the station number of the target station.</p> <p>(1) Station number specification</p> <ul style="list-style-type: none"> • 125: Master station • 126: Master operating station • 1 to 120: Local station, intelligent device station, submaster station <p>(2) All-station specification</p> <ul style="list-style-type: none"> • 00FFH: All stations of target network number (broadcast (excluding the own station)) (Can be specified for remote RUN/STOP) <p>[CC-Link IE TSN] ■When "0" is specified in bit 15 of (s1)+0 Specify the station number of the target station.</p> <p>(1) Station number specification</p> <ul style="list-style-type: none"> • 1 to 120: Local station • 125: Master station <p>(2) Group number specification</p> <ul style="list-style-type: none"> • 0081H to 00A0H: All stations with group numbers 0001H to 0020H (Can be specified for remote RUN/STOP) <p>(3) All-station specification</p> <ul style="list-style-type: none"> • 00FFH: All stations of target network number (broadcast (excluding the own station)) (Can be specified for remote RUN/STOP) <p>■When "1" is specified in bit 15 of (s1)+0 Specify the IP address (first and second octets) of the target station.</p> <p>b15 ... b8 b7 ... b0</p> <table border="1" style="width: 100%; border-collapse: collapse;"> <tr> <td style="width: 50%; height: 15px;"></td> <td style="width: 50%; height: 15px;"></td> </tr> </table> <ul style="list-style-type: none"> • b8 to b15: 1st octet • b0 to b7: 2nd octet <p>[MELSECNET/H] Specify the station number of the target station.</p> <p>(1) Station number specification</p> <ul style="list-style-type: none"> • 1 to 64: Station number <p>(2) Group number specification</p> <ul style="list-style-type: none"> • 0081H to 00A0H: All stations with group numbers 0001H to 0020H (Can be specified for remote RUN/STOP) <p>(3) All-station specification</p> <ul style="list-style-type: none"> • 00FFH: All stations of target network number (broadcast (excluding the own station)) (Can be specified for remote RUN/STOP) 			<ul style="list-style-type: none"> ■(s1)+4, 5 • IP address: 0000001H to FFFFFFFEH 	User
+6	Not used	—	—	—		

Operand: (s1)						
Device	Item	Description	Setting range	Set by		
+7	Number of resends	<p>■Before instruction execution Specify the number of resends to be performed if the instruction is not completed within the monitoring time specified by (s1)+8.</p> <ul style="list-style-type: none"> • 0 to 15 times <p>■At completion of instruction The number of resends performed (result) is stored.</p> <ul style="list-style-type: none"> • 0 to 15 times 	0 to 15	User/ system		
+8	Arrival monitoring time	<p>[CC-Link IE TSN, CC-Link IE Controller Network, CC-Link IE Field Network, or MELSECNET/H] Specify the monitoring time until completion of processing. If processing is not completed within the monitoring time, the request is resent by the number of resends specified in (s1)+7.</p> <ul style="list-style-type: none"> • 0: 10s • 1 to 32767: 1 to 32767s 	0 to 32767	User		
		<p>[Ethernet] Specify the monitoring time until completion of processing. If processing is not completed within the monitoring time, the request is resent by the number of resends specified in (s1)+7.</p> <ul style="list-style-type: none"> • 0 to (TCP resend timer value): The TCP resend timer value is assumed as the monitoring time. • (TCP resend timer value + 1) to 16383: (TCP resend timer value + 1) to 16383s 	0 to 16383	User		
+9	Request data length	<p>Specify the number of request data (words). (Number of words of data stored in the request data storage device (s2))</p> <ul style="list-style-type: none"> • Remote RUN: 4 • Remote STOP: 3 	3, 4	User		
+10	Response data length	<p>The number of response data (words) is stored. (Number of words of data stored in the response data storage device)</p> <ul style="list-style-type: none"> • Remote RUN/STOP: 2 	2	System		
+11	Clock setting flag	<p>The validity status (valid or invalid) of the data in (s1)+12 and later is stored. Note that the data in (s1)+12 and later is not cleared even when the instruction is completed successfully.</p> <ul style="list-style-type: none"> • 0: Invalid • 1: Valid 	—	System		
+12	Clock data (Set only in an abnormal state) (No information is stored if an error is detected in the own station.)	<p>Upper 8 bits: Month (01H to 12H) Lower 8 bits: Lower 2 digits of year (00H to 99H)</p>	—	System		
+13		<p>Upper 8 bits: Hour (00H to 23H) Lower 8 bits: Day (01H to 31H)</p>	—	System		
+14		<p>Upper 8 bits: Second (00H to 59H) Lower 8 bits: Minute (00H to 59H)</p>	—	System		
+15		<p>Upper 8 bits: Year (00H to 99H: Upper two digits of the year) Lower 8 bits: Day of the week (00H (Sun.) to 06H (Sat.))</p>	—	System		
+16		Error detection network number	<p>■When "0" is specified in bit 15 of (s1)+0 The network number of the station in which an error was detected is stored. (No information is stored if an error is detected in the own station.)</p> <ul style="list-style-type: none"> • 1 to 239 (Network number) <p>■When "1" is specified in bit 15 of (s1)+0 (CC-Link IE TSN only) The IP address (third and fourth octets) in which an error is detected is stored.</p> <p>b15 ... b8 b7 ... b0</p> <table border="1" style="width: 100%; border-collapse: collapse;"> <tr> <td style="width: 50%; height: 15px;"></td> <td style="width: 50%; height: 15px;"></td> </tr> </table> <ul style="list-style-type: none"> • b8 to b15: 3rd octet • b0 to b7: 4th octet 			—

Operand: (s1)						
Device	Item	Description	Setting range	Set by		
+17	Error-detected station number	<p>■When "0" is specified in bit 15 of (s1)+0 The station number of the station where an error was detected is stored. (No information is stored if an error is detected in the own station.) [Ethernet or CC-Link IE Controller Network]</p> <ul style="list-style-type: none"> • 1 to 120: Station number <p>[CC-Link IE Field Network]</p> <ul style="list-style-type: none"> • 125: Master station • 1 to 120: Local station, intelligent device station, submaster station <p>[CC-Link IE TSN]</p> <ul style="list-style-type: none"> • 125: Master station • 1 to 120: Slave station <p>[MELSECNET/H]</p> <ul style="list-style-type: none"> • 1 to 64: Station number <p>■When "1" is specified in bit 15 of (s1)+0 (CC-Link IE TSN only) The IP address (first and second octets) of the station where an error was detected is stored. (No information is stored if an error is detected in the own station.)</p> <p>b15 ... b8 b7 ... b0</p> <table border="1" style="width: 100%; border-collapse: collapse;"> <tr> <td style="width: 50%; height: 15px;"></td> <td style="width: 50%; height: 15px;"></td> </tr> </table> <ul style="list-style-type: none"> • b8 to b15: 1st octet • b0 to b7: 2nd octet 			—	System

Request data

Operand: (s2)					
Device	Item	Description	Remote RUN	Remote STOP	Set by
+0	Request type	<ul style="list-style-type: none"> • 0010H: When the station number is specified by (s1)+5 • 0030H: When All Station or the group is specified by (s1)+5 	○	○	User
+1	Subrequest type	<ul style="list-style-type: none"> • 0001H: Remote RUN • 0002H: Remote STOP 	○	○	User
+2	Operation mode	Specify whether to forcibly execute Remote RUN/STOP. Remote RUN <ul style="list-style-type: none"> • 0001H: Do not forcibly execute. • 0003H: Forcibly execute (can be specified when executing Remote RUN). Remote STOP <ul style="list-style-type: none"> • 0003H (fixed) (Forced execution is the function used, when the station that executed Remote STOP can no longer executed Remote RUN, to allow another station to forcibly execute Remote RUN.)	○	○	User
+3	Clear mode	Effective only for Remote RUN. Specify whether to clear the CPU device memory. <ul style="list-style-type: none"> • 0000H: Do not clear (the local device is cleared, though). • 0001H: Clear (excluding the setting at Remote RUN and the latch range) • 0002H: Clear (including the setting at Remote RUN and the latch range) 	○	—	User

Response data

Operand: (d1)					
Device	Item	Description	Remote RUN	Remote STOP	Set by
+0	Request type	<ul style="list-style-type: none"> • 0090H: When the station number is specified by (s1)+5 	○	○	System
+1	Subrequest type	<ul style="list-style-type: none"> • 0001H: Remote RUN • 0002H: Remote STOP 	○	○	System

Point

- For details on the remote operation, refer to the user's manual for the CPU module used.
- Remote RUN/STOP is valid when the RUN/STOP key switch on the RCP, QCP, LCP, or QnACP of the target station is set to RUN.
- Remote RUN/STOP is disabled when System Protect is applied to the CPU module of the target station.
- While another station already executes Remote STOP/PAUSE for the target station, the own station cannot execute RUN if "Do not forcibly execute" is set in (s2)+2.
- If the RCP, QCP, LCP, or QnACP of the target station for which Remote RUN/STOP has been executed is reset, the Remote RUN/STOP information is deleted.
- The clear mode set in (s2)+3 is used to specify the clear processing (initialization) mode of the device memory of RCP, QCP, LCP, or QnACP when the CPU operation is started by Remote RUN. The RCP, QCP, LCP, or QnACP performs clearing as specified and runs according to the parameter setting (initial device value).
- The number of resends (s1)+7 must be set every time the instruction is executed.

Processing details

- These instructions send the request data specified by (s2) in the own station to the target station specified by the target network number and target station number of the control data. Upon completion of the request to the target station, the completion device specified by (d2) turns on.
- For the target stations that can be specified, refer to the following.

☞ Page 65 Target networks and target station types

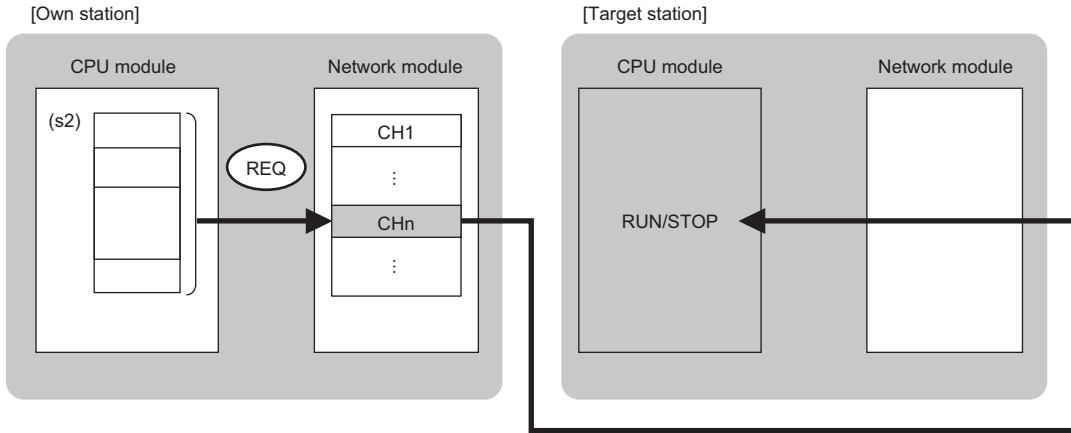

CH: Channel

- Data can be sent not only to the stations connected to the own station network, but also to stations connected to the network number specified by the following network systems. (If IP address is specified, device data cannot be read from stations connected via a relay station.)
 - Ethernet
 - CC-Link IE TSN
 - CC-Link IE Controller Network
 - CC-Link IE Field Network
 - MELSECNET/H
 - MELSECNET/10
- When executing multiple link dedicated instructions concurrently, be careful not to overlap the channels of the link dedicated instructions. Multiple link dedicated instructions specifying the same channel cannot be used concurrently.
- The execution status and the completion status of the REQ instruction can be checked with the completion device (d2) and the completion status indication device (d2)+1.
 - Completion device (d2)

This device turns on during END processing of the scan where the REQ instruction completes, and turns off during the next END processing.

- Completion status indication device (d2)+1

This device turns on or off depending on the completion status of the REQ instruction.

When completed successfully: The device remains off.

When completed with an error: The device turns on during END processing of the scan where the REQ instruction completes, and turns off during the next END processing.

• The following figure shows the execution timing of the REQ instruction.

• When completed successfully

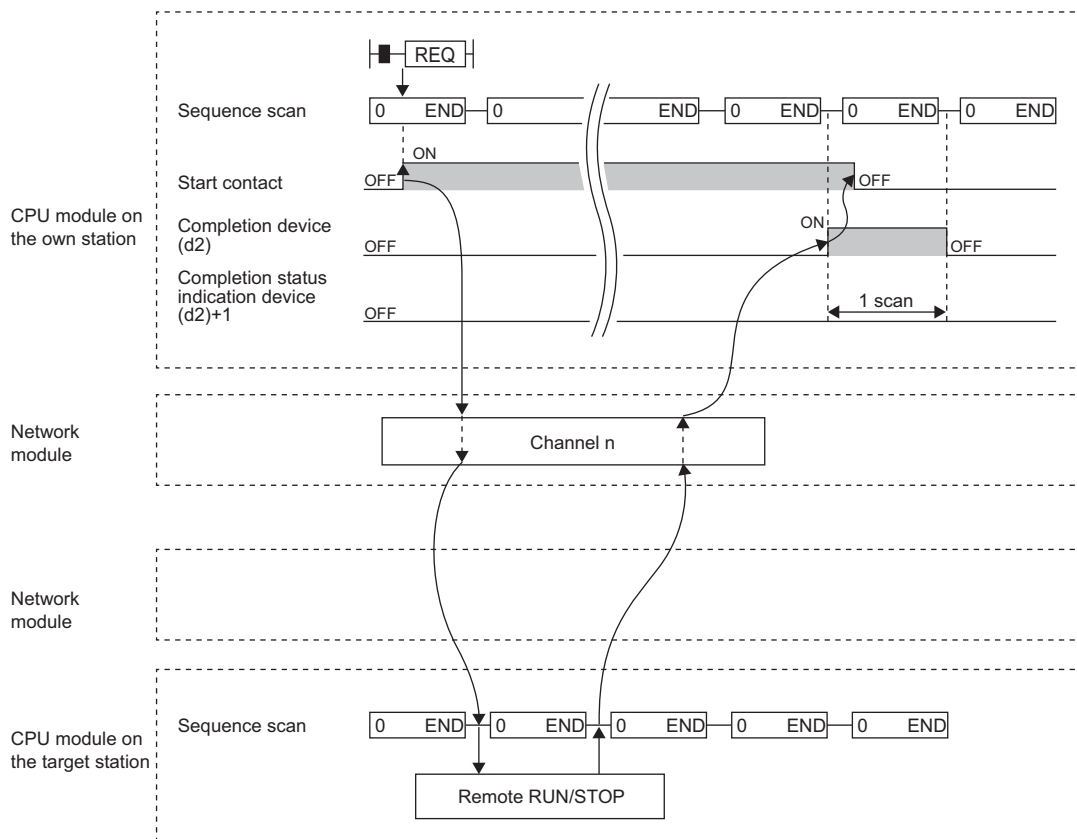



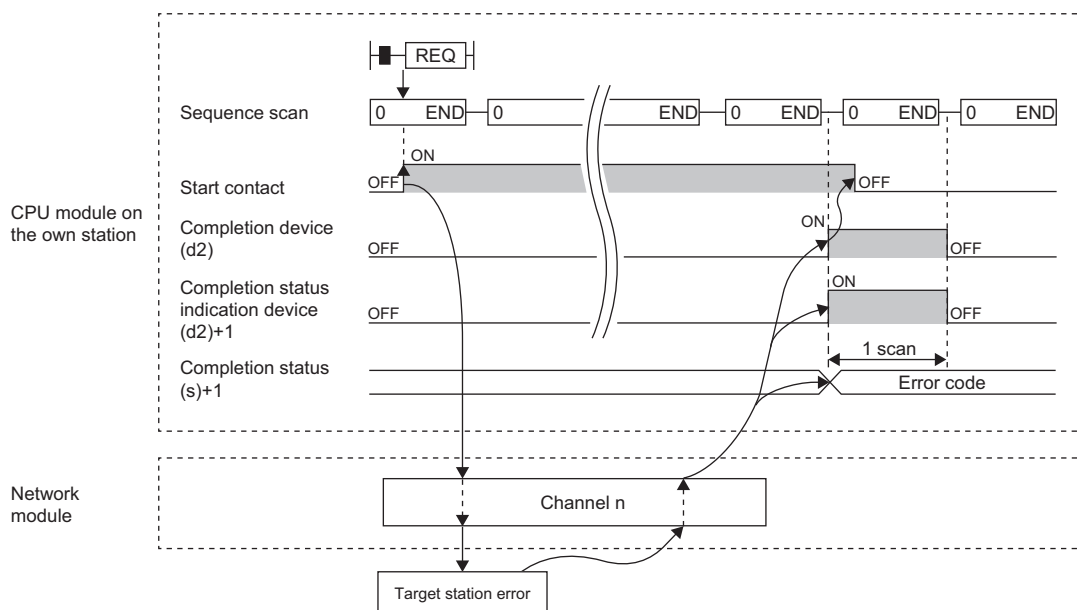







• When completed with an error



• When the J.REQ/G.REQ instruction is used for execution, one complete cycle of write processing is followed by another while the write command is on. When the JP.REQ/GP.REQ instruction is executed, write processing is performed only once on the rising edge when the write command turns on.

Operation error

Error code ((s1)+1)	Description
4000H to 4FFFH	 MELSEC iQ-R CPU Module User's Manual (Application)
6F00H to 6FFFH	 MELSEC iQ-R CPU Module User's Manual (Application)
C000H to CFBFH	 MELSEC iQ-R Ethernet User's Manual (Application)  MELSEC iQ-R CC-Link IE TSN User's Manual (Application)
CFC0H to CFFFH	 MELSEC iQ-R CPU Module User's Manual (Application)  MELSEC iQ-R CC-Link IE TSN User's Manual (Application)
D000H to DFFFH	 MELSEC iQ-R CC-Link IE Field Network User's Manual (Application)  MELSEC iQ-R CC-Link IE TSN User's Manual (Application)
E000H to EFFFH	 MELSEC iQ-R CC-Link IE Controller Network User's Manual (Application)
F000H to FFFFH	 MELSEC iQ-R MELSECNET/H Network Module User's Manual (Application)

Reading/writing clock data

J(P).REQ, G(P).REQ



These instructions read or write clock data from/to the programmable controller of another station.

Ladder	ST
	<pre>ENO:=J_REQ(EN,J,s1,s2,d1,d2); ENO:=JP_REQ(EN,J,s1,s2,d1,d2); ENO:=G_REQ(EN,U,s1,s2,d1,d2); ENO:=GP_REQ(EN,U,s1,s2,d1,d2);</pre>

FBD/LD

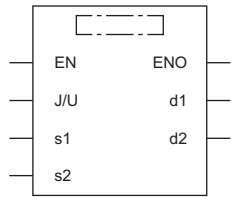

■ Execution condition

Instruction	Execution condition
J.REQ G.REQ	
JP.REQ GP.REQ	

Setting data

■ Description, range, data type

Operand	Description	Range	Data type	Data type (label)	
(J/U)	J(P).REQ	(J): Own station network number	1 to 239	16-bit unsigned binary	ANY16
	G(P).REQ	(U): Start I/O number (first three digits in four-digit hexadecimal representation) of own station or own node	00H to FEH	16-bit unsigned binary	ANY16
(s1)	Own station start device where control data is stored	Refer to the control data.	Device name	ANY16 ^{*1}	
(s2)	Own station start device where request data is stored	—	Device name	ANY16 ^{*1}	
(d1)	Own station start device for storing response data	—	Device name	ANY16 ^{*1}	
(d2)	Device of the own station, which turns on for one scan upon completion of the instruction. When the instruction completes with an error, (d2)+1 also turns on.	—	Bit	ANYBIT_ARRAY (Number of elements: 2)	
EN	Execution condition	—	Bit	BOOL	
ENO	Execution result	—	Bit	BOOL	

*1 When specifying setting data by using a label, define an array to secure enough operation area and specify an element of the array label.

■Applicable devices

Operand		Bit		Word			Double word		Indirect specification	Constant			Others	
		X, Y, M, L, SM, F, B, SB, FX, FY	J□□	T, ST, C, D, W, SD, SW, FD, R, ZR, RD	U□□□, J□□□, U3E□□(H)□□	Z	LT, LST, LC	LZ		K, H, E, \$	J, U			
(J/U)	J(P).REQ	—	—	—	—	—	—	—	—	—	—	—	○	—
	G(P).REQ	—	—	○	—	—	—	—	○	○	—	—	—	○
(s1)		—	—	○*2	—	—	—	—	○	—	—	—	—	—
(s2)		—	—	○*2	—	—	—	—	○	—	—	—	—	—
(d1)		—	—	○*2	—	—	—	—	○	—	—	—	—	—
(d2)		○*1	—	○*3	—	—	—	—	—	—	—	—	—	—

*1 FX and FY cannot be used.

*2 FD cannot be used.

*3 T, ST, C, and FD cannot be used.



The REQ instruction cannot be executed when the target station is ACPU.

■Control data

Operand: (s1)				
Device	Item	Description	Setting range	Set by
+0	Error completion type	b15 ... b7 ... b4 ... b0 (2) 0 (1) 0 1 0 1 (1) Error completion type (bit 7) Specify whether to set data at completion with an error. • 0: Do not set data in (s1)+11 and later at completion with an error. • 1: Set data in (s1)+11 and later at completion with an error. (2) Target station address specification method (bit 15) (CC-Link IE TSN only) • 0: Specify "network number" in (s1)+4, and specify "station number" in (s1)+5. • 1: Specify "IP address" in (s1)+4, 5.	0011H 0091H 8011H 8091H	User
+1	Completion status	The completion status is stored upon completion of the instruction. • 0: Normal • Other than 0: Error (error code)	—	System
+2	Own station channel	Specify the channel to be used by own station. (☞ Page 66 Range of available channels)	1 to 8, 11 to 18	User
+3	Target station CPU type	Specify the CPU type of the target station. • 0000H: Addressed to target station CPU (control CPU) • 03D0H: Addressed to control system CPU • 03D1H: Addressed to standby system CPU • 03D2H: Addressed to system A CPU • 03D3H: Addressed to system B CPU • 03E0H: Addressed to multiple CPU No.1 • 03E1H: Addressed to multiple CPU No.2 • 03E2H: Addressed to multiple CPU No.3 • 03E3H: Addressed to multiple CPU No.4 • 03FFH: Addressed to target station CPU (control CPU)	0000H 03D0H to 03D3H 03E0H to 03E3H 03FFH	User

Operand: (s1)						
Device	Item	Description	Setting range	Set by		
+4	Target network number	<p>[Ethernet, CC-Link IE Controller Network, CC-Link IE Field Network, or MELSECNET/H] Specify the network number of the target station.</p> <ul style="list-style-type: none"> • 1 to 239: Network number <p>[CC-Link IE TSN] ■When "0" is specified in bit 15 of (s1)+0 Specify the network number (1 to 239) of the target station. ■When "1" is specified in bit 15 of (s1)+0 Specify the IP address (third and fourth octets) of the target station.</p> <p>b15 ... b8 b7 ... b0</p> <table border="1" style="width: 100%; border-collapse: collapse;"> <tr> <td style="width: 50%; height: 15px;"></td> <td style="width: 50%; height: 15px;"></td> </tr> </table> <ul style="list-style-type: none"> • b8 to b15: 3rd octet • b0 to b7: 4th octet 			<ul style="list-style-type: none"> ■(s1)+4 • Network number: 1 to 239 ■(s1)+5 • Station number: 1 to 120, 125, 126 • Group number: 0081H to 00A0H • All-station specification: 00FFH ■(s1)+4, 5 • IP address: 0000001H to FFFFFFFEH 	User
+5	Target station number	<p>[Ethernet or CC-Link IE Controller Network] Specify the station number of the target station.</p> <p>(1) Station number specification</p> <ul style="list-style-type: none"> • 1 to 120: Station number <p>(2) Group number specification</p> <ul style="list-style-type: none"> • 0081H to 00A0H: All stations with group numbers 0001H to 0020H (Can be specified for remote RUN/STOP) <p>(3) All-station specification</p> <ul style="list-style-type: none"> • 00FFH: All stations of target network number (broadcast (excluding the own station)) (Can be specified for remote RUN/STOP) <p>[CC-Link IE Field Network] Specify the station number of the target station.</p> <p>(1) Station number specification</p> <ul style="list-style-type: none"> • 125: Master station • 126: Master operating station • 1 to 120: Local station, intelligent device station, submaster station <p>(2) All-station specification</p> <ul style="list-style-type: none"> • 00FFH: All stations of target network number (broadcast (excluding the own station)) (Can be specified for remote RUN/STOP) <p>[CC-Link IE TSN] ■When "0" is specified in bit 15 of (s1)+0 Specify the station number of the target station.</p> <p>(1) Station number specification</p> <ul style="list-style-type: none"> • 1 to 120: Local station • 125: Master station <p>(2) Group number specification</p> <ul style="list-style-type: none"> • 0081H to 00A0H: All stations with group numbers 0001H to 0020H (Can be specified for remote RUN/STOP) <p>(3) All-station specification</p> <ul style="list-style-type: none"> • 00FFH: All stations of target network number (broadcast (excluding the own station)) (Can be specified for remote RUN/STOP) <p>■When "1" is specified in bit 15 of (s1)+0 Specify the IP address (first and second octets) of the target station.</p> <p>b15 ... b8 b7 ... b0</p> <table border="1" style="width: 100%; border-collapse: collapse;"> <tr> <td style="width: 50%; height: 15px;"></td> <td style="width: 50%; height: 15px;"></td> </tr> </table> <ul style="list-style-type: none"> • b8 to b15: 1st octet • b0 to b7: 2nd octet <p>[MELSECNET/H] Specify the station number of the target station.</p> <p>(1) Station number specification</p> <ul style="list-style-type: none"> • 1 to 64: Station number <p>(2) Group number specification</p> <ul style="list-style-type: none"> • 0081H to 00A0H: All stations with group numbers 0001H to 0020H (Can be specified for remote RUN/STOP) <p>(3) All-station specification</p> <ul style="list-style-type: none"> • 00FFH: All stations of target network number (broadcast (excluding the own station)) (Can be specified for remote RUN/STOP) 			<ul style="list-style-type: none"> ■(s1)+4, 5 • IP address: 0000001H to FFFFFFFEH 	User
+6	Not used	—	—	—		

Operand: (s1)								
Device	Item	Description	Setting range	Set by				
+7	Number of resends	<p>■Before instruction execution Specify the number of resends to be performed if the instruction is not completed within the monitoring time specified by (s1)+8.</p> <ul style="list-style-type: none"> • 0 to 15 times <p>■At completion of instruction The number of resends performed (result) is stored.</p> <ul style="list-style-type: none"> • 0 to 15 times 	0 to 15	User/ system				
+8	Arrival monitoring time	<p>[CC-Link IE TSN, CC-Link IE Controller Network, CC-Link IE Field Network, or MELSECNET/H] Specify the monitoring time until completion of processing. If processing is not completed within the monitoring time, the request is resent by the number of resends specified in (s1)+7.</p> <ul style="list-style-type: none"> • 0: 10s • 1 to 32767: 1 to 32767s 	0 to 32767	User				
		<p>[Ethernet] Specify the monitoring time until completion of processing. If processing is not completed within the monitoring time, the request is resent by the number of resends specified in (s1)+7.</p> <ul style="list-style-type: none"> • 0 to (TCP resend timer value): The TCP resend timer value is assumed as the monitoring time. • (TCP resend timer value + 1) to 16383: (TCP resend timer value + 1) to 16383s 	0 to 16383	User				
+9	Request data length	<p>Specify the number of request data (words). (Number of words of data stored in the request data storage device (s2))</p> <ul style="list-style-type: none"> • Reading clock data: 2 • Writing clock data: 6 	2, 6	User				
+10	Response data length	<p>The number of response data (words) is stored. (Number of words of data stored in the response data storage device)</p> <ul style="list-style-type: none"> • Reading clock data: 6 • Writing clock data: 2 	2, 6	System				
+11	Clock setting flag	<p>The validity status (valid or invalid) of the data in (s1)+12 and later is stored. Note that the data in (s1)+12 and later is not cleared even when the instruction is completed successfully.</p> <ul style="list-style-type: none"> • 0: Invalid • 1: Valid 	—	System				
+12	Clock data (Set only in an abnormal state) (No information is stored if an error is detected in the own station.)	Upper 8 bits: Month (01H to 12H) Lower 8 bits: Lower 2 digits of year (00H to 99H)	—	System				
+13		Upper 8 bits: Hour (00H to 23H) Lower 8 bits: Day (01H to 31H)	—	System				
+14		Upper 8 bits: Second (00H to 59H) Lower 8 bits: Minute (00H to 59H)	—	System				
+15		Upper 8 bits: Year (00H to 99H: Upper two digits of the year) Lower 8 bits: Day of the week (00H (Sun.) to 06H (Sat.))	—	System				
+16		Error detection network number	<p>■When "0" is specified in bit 15 of (s1)+0 The network number of the station in which an error was detected is stored. (No information is stored if an error is detected in the own station.)</p> <ul style="list-style-type: none"> • 1 to 239 (Network number) <p>■When "1" is specified in bit 15 of (s1)+0 (CC-Link IE TSN only) The IP address (third and fourth octets) in which an error is detected is stored.</p> <p>b15 ... b8 b7 ... b0</p> <table border="1" style="margin-left: 20px;"> <tr> <td style="width: 40px; height: 15px;"></td> <td style="width: 40px; height: 15px;"></td> <td style="width: 40px; height: 15px;"></td> <td style="width: 40px; height: 15px;"></td> </tr> </table> <ul style="list-style-type: none"> • b8 to b15: 3rd octet • b0 to b7: 4th octet 					—

Operand: (s1)						
Device	Item	Description	Setting range	Set by		
+17	Error-detected station number	<p>■When "0" is specified in bit 15 of (s1)+0 The station number of the station where an error was detected is stored. (No information is stored if an error is detected in the own station.) [Ethernet or CC-Link IE Controller Network]</p> <ul style="list-style-type: none"> • 1 to 120: Station number <p>[CC-Link IE Field Network]</p> <ul style="list-style-type: none"> • 125: Master station • 1 to 120: Local station, intelligent device station, submaster station <p>[CC-Link IE TSN]</p> <ul style="list-style-type: none"> • 125: Master station • 1 to 120: Slave station <p>[MELSECNET/H]</p> <ul style="list-style-type: none"> • 1 to 64: Station number <p>■When "1" is specified in bit 15 of (s1)+0 (CC-Link IE TSN only) The IP address (first and second octets) of the station where an error was detected is stored. (No information is stored if an error is detected in the own station.)</p> <p>b15 ... b8 b7 ... b0</p> <table border="1" style="width: 100%; border-collapse: collapse;"> <tr> <td style="width: 50%; height: 15px;"></td> <td style="width: 50%; height: 15px;"></td> </tr> </table> <ul style="list-style-type: none"> • b8 to b15: 1st octet • b0 to b7: 2nd octet 			—	System

Request data

Operand: (s2)															
Device	Item	Description	Reading clock data	Writing clock data	Set by										
+0	Request type	<ul style="list-style-type: none"> • 0001H: Reading clock data • 0011H: Writing clock data (with a station number specified in (s1)+5) • 0031H: Writing clock data (with All Station or a group specified in (s1)+5) 	○	○	User										
+1	Subrequest type	<ul style="list-style-type: none"> • 0002H: Reading clock data • 0001H: Writing clock data 	○	○	User										
+2	Change pattern	<p>■Change pattern (bits 0 to 6) Specify which item from the upper byte in (s2)+2 to (s2)+5 should be written.</p> <ul style="list-style-type: none"> • 0: Not changed • 1: Changed <p>■Changed year (bits 8 to 15) Specify the year (two lower digits) in BCD code.*1</p> <p>b15 ... b8 b7 b6 b5 b4 b3 b2 b1 b0</p> <table border="1" style="margin-left: 40px;"> <tr> <td style="width: 100px;">Year (00H to 99H)</td> <td>0</td> <td></td> <td></td> <td></td> <td></td> <td></td> <td></td> <td></td> <td></td> </tr> </table> <p>b6: Day of week, b5: Second, b4: Minute, b3: Hour, b2: Day, b1: Month, b0: Year</p>	Year (00H to 99H)	0									—	○	User
Year (00H to 99H)	0														
+3	Changed clock data	Upper 8 bits: Day (01H to 31H) Lower 8 bits: Month (01H to 12H)	—	○	User										
+4		Upper 8 bits: Minute (00H to 59H) Lower 8 bits: Hour (00H to 23H)	—	○	User										
+5		Upper 8 bits: Day of week (00H (Sunday) to 06H (Saturday)) Lower 8 bits: Second (00H to 59H)	—	○	User										

*1 Writing clock data using the REQ instruction cannot change the upper two digits of the year. If the year needs to be changed including the upper two digits as well, use the engineering tool to set the clock data.

Response data

Operand: (d1)					
Device	Item	Description	Reading clock data	Writing clock data	Set by
+0	Request type	<ul style="list-style-type: none"> • 0081H: Reading clock data • 0091H: Writing clock data 	○	○	System
+1	Subrequest type	<ul style="list-style-type: none"> • 0002H: Reading clock data • 0001H: Writing clock data 	○	○	System
+2	Clock data that has been read	Upper 8 bits: Month (01H to 12H) Lower 8 bits: Lower 2 digits of year (00H to 99H)	○	—	System
+3		Upper 8 bits: Hour (00H to 23H) Lower 8 bits: Day (01H to 31H)	○	—	System
+4		Upper 8 bits: Second (00H to 59H) Lower 8 bits: Minute (00H to 59H)	○	—	System
+5		Upper 8 bits: (00H) Lower 8 bits: Day of the week (00H (Sun.) to 06H (Sat.))	○	—	System

Point

- For details on the clock function, refer to the user's manual for the CPU module used.
- Clock data cannot be read or written when System Protect is applied to the CPU module of the target station.
- When clock data is read, a continuous area for six words is required for the response data storage device (d1).

Processing details

- These instructions send the request data specified by (s2) in the own station to the target station specified by the target network number and target station number of the control data. Upon completion of the request to the target station, the completion device specified by (d2) turns on.
- For the target stations that can be specified, refer to the following.

☞ Page 65 Target networks and target station types

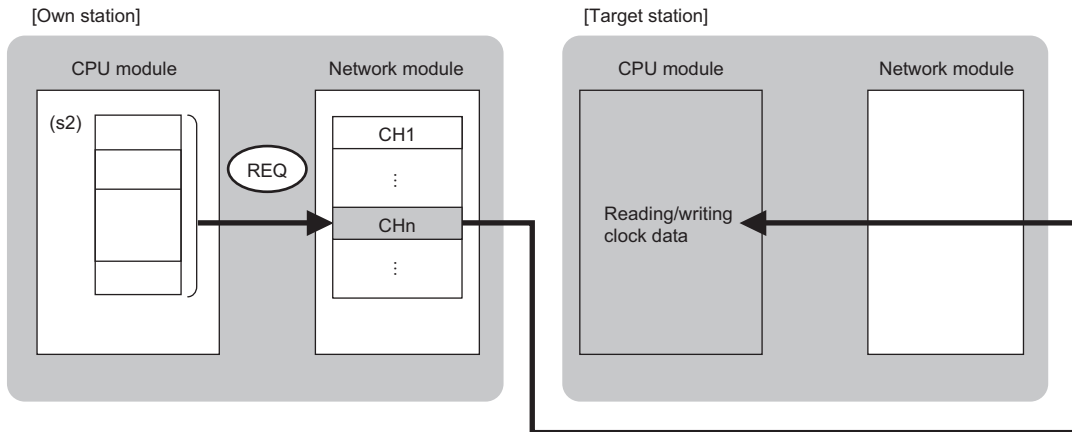

CH: Channel

- Data can be sent not only to the stations connected to the own station network, but also to stations connected to the network number specified by the following network systems. (If IP address is specified, device data cannot be read from stations connected via a relay station.)
 - Ethernet
 - CC-Link IE TSN
 - CC-Link IE Controller Network
 - CC-Link IE Field Network
 - MELSECNET/H
 - MELSECNET/10
- When executing multiple link dedicated instructions concurrently, be careful not to overlap the channels of the link dedicated instructions. Multiple link dedicated instructions specifying the same channel cannot be used concurrently.
- The execution status and the completion status of the REQ instruction can be checked with the completion device (d2) and the completion status indication device (d2)+1.
 - Completion device (d2)

This device turns on during END processing of the scan where the REQ instruction completes, and turns off during the next END processing.

- Completion status indication device (d2)+1

This device turns on or off depending on the completion status of the REQ instruction.

When completed successfully: The device remains off.

When completed with an error: The device turns on during END processing of the scan where the REQ instruction completes, and turns off during the next END processing.

• The following figure shows the execution timing of the REQ instruction.

• When completed successfully

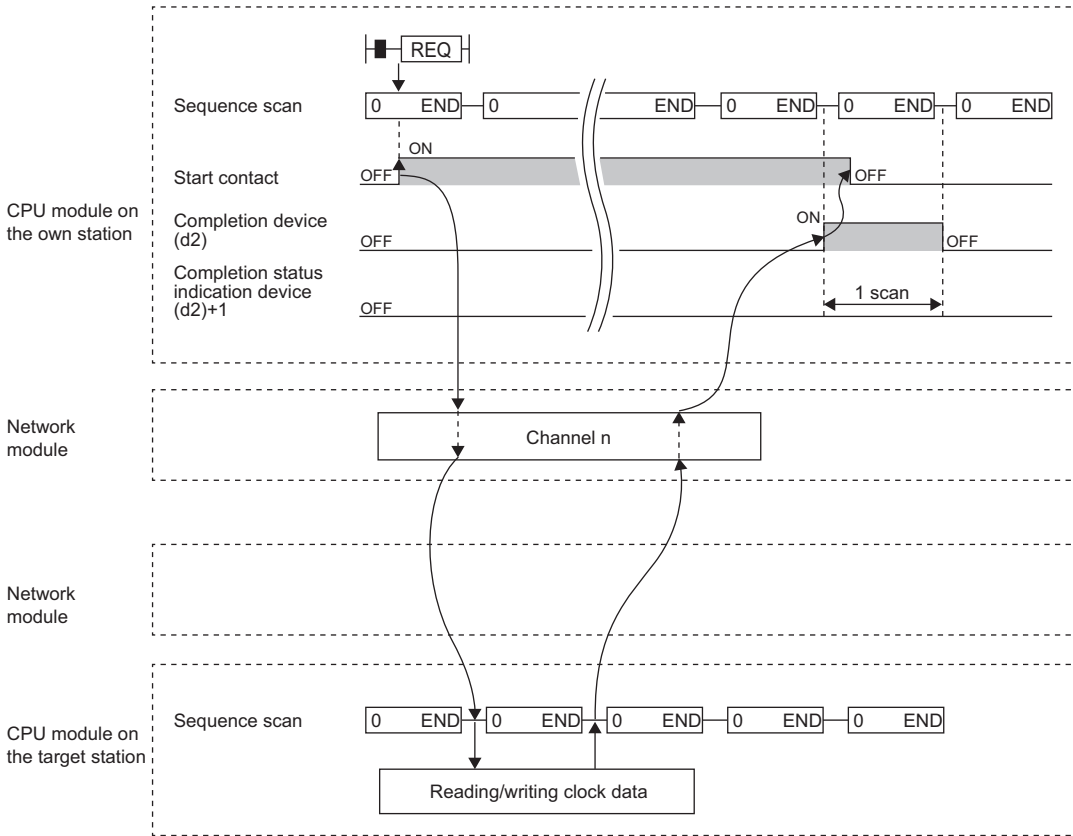



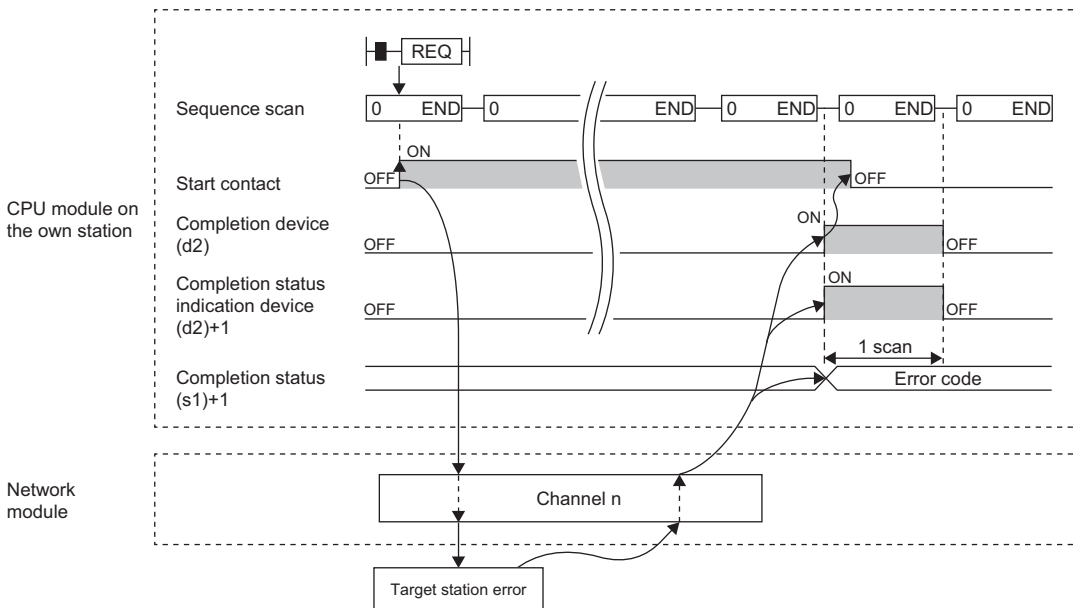







• When completed with an error



• When the J.REQ/G.REQ instruction is used for execution, one complete cycle of write processing is followed by another while the write command is on. When the JP.REQ/GP.REQ instruction is executed, write processing is performed only once on the rising edge when the write command turns on.

Operation error

Error code ((s1)+1)	Description
4000H to 4FFFH	 MELSEC iQ-R CPU Module User's Manual (Application)
6F00H to 6FFFH	 MELSEC iQ-R CPU Module User's Manual (Application)
C000H to CFBFH	 MELSEC iQ-R Ethernet User's Manual (Application)  MELSEC iQ-R CC-Link IE TSN User's Manual (Application)
CFC0H to CFFFH	 MELSEC iQ-R CPU Module User's Manual (Application)  MELSEC iQ-R CC-Link IE TSN User's Manual (Application)
D000H to DFFFH	 MELSEC iQ-R CC-Link IE Field Network User's Manual (Application)  MELSEC iQ-R CC-Link IE TSN User's Manual (Application)
E000H to EFFFH	 MELSEC iQ-R CC-Link IE Controller Network User's Manual (Application)
F000H to FFFFH	 MELSEC iQ-R MELSECNET/H Network Module User's Manual (Application)

3.2 CC-Link Dedicated Instructions

Reading data from the target station

J(P).RIRD, G(P).RIRD

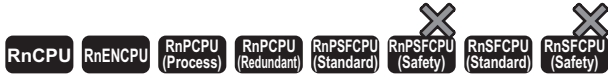

These instructions read the specified number of points of data from a device of the target station.

Ladder	ST
	<pre>ENO:=J_RIRD(EN,J,s,d1,d2); ENO:=JP_RIRD(EN,J,s,d1,d2); ENO:=G_RIRD(EN,U,s,d1,d2); ENO:=GP_RIRD(EN,U,s,d1,d2);</pre>

FBD/LD

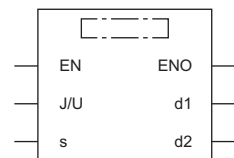

Execution condition

Instruction	Execution condition
J.RIRD G.RIRD	
JP.RIRD GP.RIRD	

Setting data

Description, range, data type

Operand	Description	Range	Data type	Data type (label)
(J/U)	J(P).RIRD (J): Own station network number G(P).RIRD (U): Start I/O number (first three digits in four-digit hexadecimal representation) of own station or own node	1 to 239 00H to FEH	16-bit unsigned binary 16-bit unsigned binary	ANY16 ANY16
(s)	Own station start device where control data is stored	Refer to the control data.	Device name	ANY16 ^{*1}
(d1)	Own station start device for storing the read data (A continuous area for the read data length is required.)	—	Device name	ANY16 ^{*1}
(d2)	Device of the own station, which turns on for one scan upon completion of the instruction. When the instruction completes with an error, (d2)+1 also turns on.	—	Bit	ANYBIT_ARRAY (Number of elements: 2)
EN	Execution condition	—	Bit	BOOL
ENO	Execution result	—	Bit	BOOL

*1 When specifying setting data by using a label, define an array to secure enough operation area and specify an element of the array label.

■Applicable devices

Operand		Bit		Word			Double word		Indirect specification	Constant			Others	
		X, Y, M, L, SM, F, B, SB, FX, FY	J□□	T, ST, C, D, W, SD, SW, FD, R, ZR, RD	U□\G□, J□\□, U3E□\□(H)G□	Z	LT, LST, LC	LZ		K, H, E, \$	J, U			
(J/U)	J(P).RIRD	—	—	—	—	—	—	—	—	—	—	—	○	—
	G(P).RIRD	—	—	○	—	—	—	—	○	○	—	—	—	○
(s)		—	—	○*2	—	—	—	—	○	—	—	—	—	—
(d1)		—	—	○*2	—	—	—	—	○	—	—	—	—	—
(d2)		○*1	—	○*3	—	—	—	—	—	—	—	—	—	—

*1 FX and FY cannot be used.

*2 FD cannot be used.

*3 T, ST, C, and FD cannot be used.

■Control data

Operand: (s)				
Device	Item	Description	Setting range	Set by
+0	Completion status	The completion status is stored upon completion of the instruction. • 0: Normal • Other than 0: Error (error code)	—	System
+1	Target station number	Specifies the station number of the target station.	0 to 120	User
+2	Access/attribute code	Specify the access code and attribute code of the device to read. <div style="display: flex; align-items: center; gap: 10px;"> b15 ... b8 b7 ... b0 </div> <div style="border: 1px solid black; width: 150px; height: 15px; margin: 5px auto;"></div> <ul style="list-style-type: none"> • b8 to b15: Access code • b0 to b7: Attribute code 	Refer to "Access/attribute code."	User
+3	Device number	Specify the start number of the device to read.	Within device range	User
+4	Number of read points	Specify the number of data in units of words to read from the device.	1 to 480	User

■ Access/attribute code

Device category* ¹	Name	Date type		Unit	Access code* ²	Attribute code* ²
		Bit	Word			
Input relay	X	○	—	Hexadecimal	01H	05H
Output relay	Y	○	—	Hexadecimal	02H	05H
Internal relay	M	○	—	Decimal	03H	05H
Latch relay	L	○	—	Decimal	83H	05H
Link relay	B	○	—	Hexadecimal	23H	05H
Timer (contact)	T	○	—	Decimal	09H	05H
Timer (coil)	T	○	—	Decimal	0AH	05H
Timer (current value)	T	—	○	Decimal	0CH	05H
Retentive timer (contact)	ST	○	—	Decimal	89H	05H
Retentive timer (coil)	ST	○	—	Decimal	8AH	05H
Retentive timer (current value)	ST	—	○	Decimal	8CH	05H
Counter (contact)	C	○	—	Decimal	11H	05H
Counter (coil)	C	○	—	Decimal	12H	05H
Counter (current value)	C	—	○	Decimal	14H	05H
Data register* ³	D	—	○	Decimal	04H	05H
Link register* ³	W	—	○	Hexadecimal	24H	05H
File register	R	—	○	Decimal	84H	05H
Link special relay	SB	○	—	Hexadecimal	63H	05H
Link special register	SW	—	○	Hexadecimal	64H	05H
Special relay	SM	○	—	Decimal	43H	05H
Special register	SD	—	○	Decimal	44H	05H

*1 Any device other than the above cannot be accessed. To access a bit device, specify 0 or a multiple of 16.

*2 When the target station is other than the CC-Link IE Controller Network module and CC-Link IE Field Network master/local module, refer to the manual of the target station.

*3 D65536 and the subsequent extended data registers and of W10000 and the subsequent extended link registers cannot be specified.

Point

The RIRD instruction can set the arrival monitoring time and the number of resends in the following link special registers (SW).

- RIRD/RIWT instruction: Arrival monitoring time (SW0009)
- RIRD/RIWT instruction: Number of resends (SW000B)

When "RIRD/RIWT instruction: Number of resends (SW000B)" is set, the time taken for the RIRD instruction to be completed with an error is determined by the following.

(RIRD/RIWT instruction: Number of resends + 1) × RIRD/RIWT instruction: Arrival monitoring time

However, if the target station (relay source station when addressed to another network) has been disconnected at the time of RIRD instruction execution, no retry is executed. If the RIRD instruction is completed with an error, re-execute the RIRD instruction after the target station (relay source station when addressed to another network) returns.

If an error (error code: E504H) occurs in CC-Link IE Controller Network, a retry cannot be performed. Wait until the instruction completes with an error, and execute the RIRD instruction again.

Processing details

- These instructions read the number of words of data specified by (s)+4 from the start device of the target station specified by (s)+2 and (s)+3, and put the data in the word device in the own station specified by (d1) and after. Specify the target station in (s)+1. Upon completion of reading the data from the target station, the completion device specified by (d2) turns on.

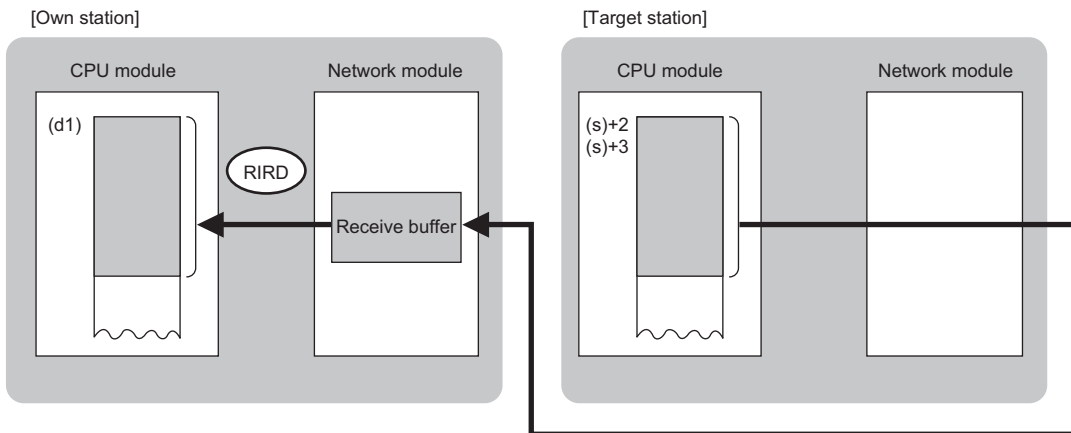

- The execution status and the completion status of the RIRD instruction can be checked with the completion device (d2) and the completion status indication device (d2)+1.

- Completion device (d2)

This device turns on during END processing of the scan where the RIRD instruction completes, and turns off during the next END processing.

- Completion status indication device (d2)+1

This device turns on or off depending on the completion status of the RIRD instruction.

When completed successfully: The device remains off.

When completed with an error: The device turns on during END processing of the scan where the RIRD instruction completes, and turns off during the next END processing.

- The following figure shows the execution timing of the RIRD instruction.

- When completed successfully

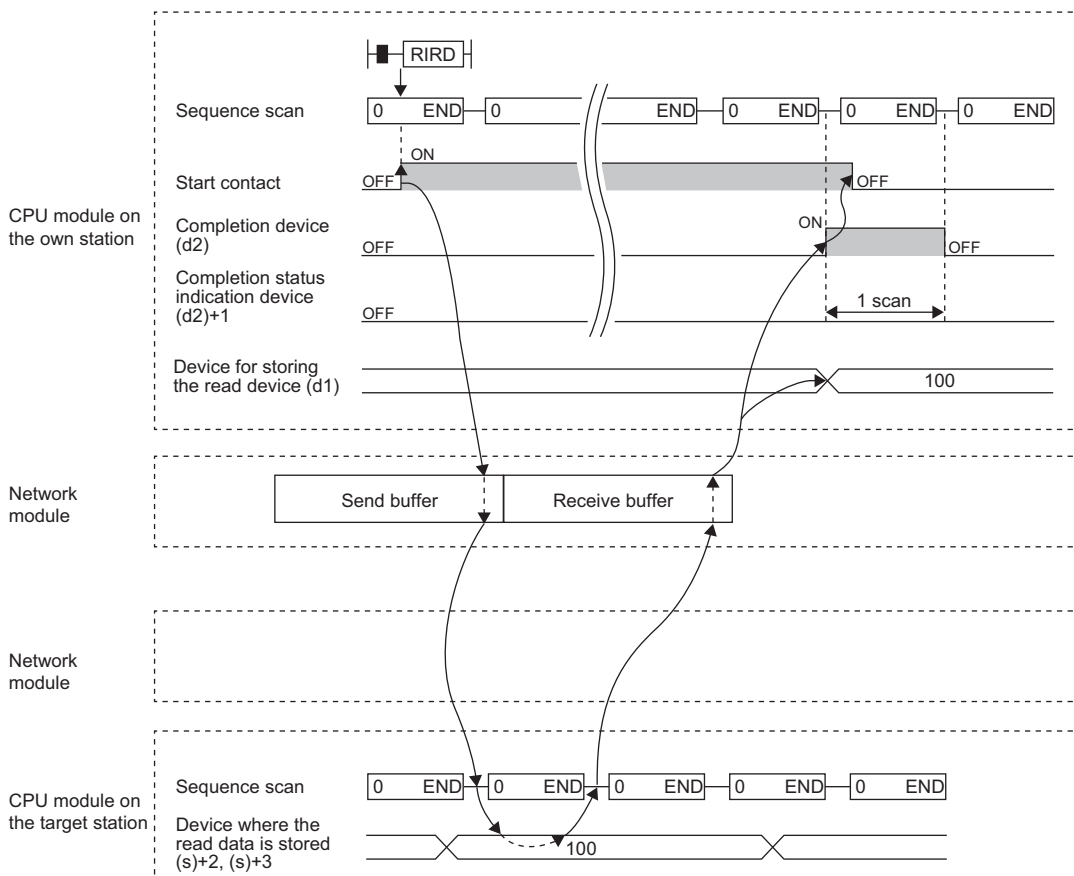

- When completed with an error

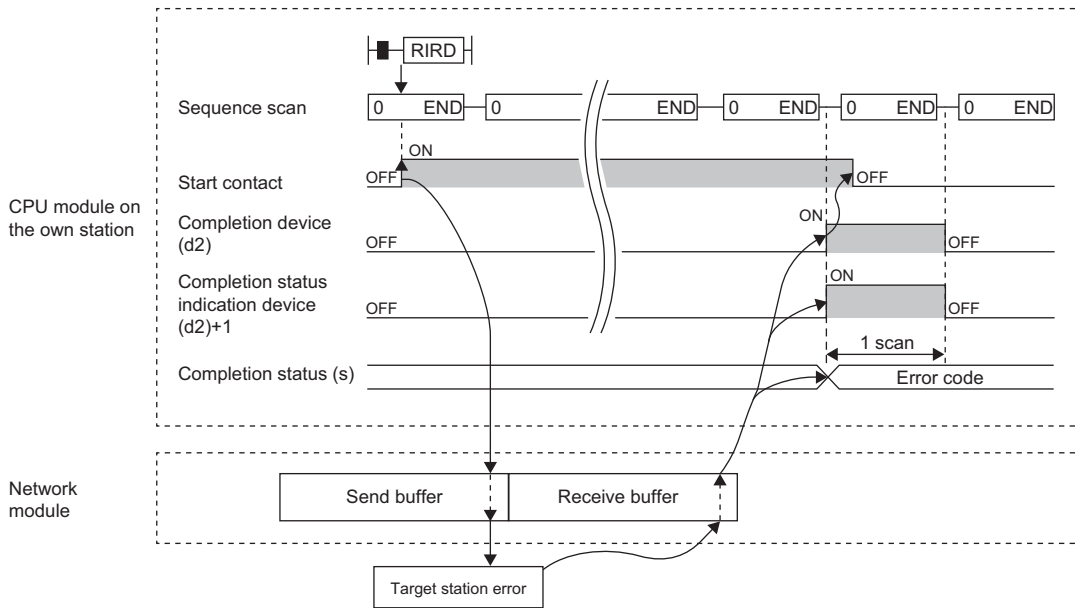

Operation error

Error code ((s)+0)	Description
4000H to 4FFFH	MELSEC iQ-R CPU Module User's Manual (Application)
D000H to DFFFH	MELSEC iQ-R CC-Link IE Field Network User's Manual (Application)
E000H to EFFFH	MELSEC iQ-R CC-Link IE Controller Network User's Manual (Application)

Writing data to the target station

J(P).RIWT, G(P).RIWT

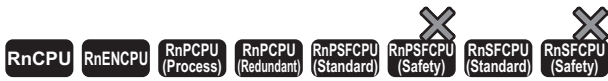

These instructions write the specified number of points of data to a device of the target station.

Ladder	ST
	<pre> ENO:=J_RIWT(EN,J,s1,s2,d); ENO:=JP_RIWT(EN,J,s1,s2,d); ENO:=G_RIWT(EN,U,s1,s2,d); ENO:=GP_RIWT(EN,U,s1,s2,d); </pre>

FBD/LD

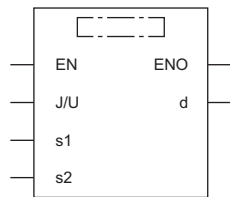

Execution condition

Instruction	Execution condition
J.RIWT G.RIWT	
JP.RIWT GP.RIWT	

Setting data

Description, range, data type

Operand	Description	Range	Data type	Data type (label)
(J/U)	J(P).RIWT (J): Own station network number	1 to 239	16-bit unsigned binary	ANY16
	G(P).RIWT (U): Start I/O number (first three digits in four-digit hexadecimal representation) of own station or own node	00H to FEH	16-bit unsigned binary	ANY16
(s1)	Own station start device where control data is stored	Refer to the control data.	Device name	ANY16 ^{*1}
(s2)	Own station start device for storing written data	—	Device name	ANY16 ^{*1}
(d)	Device of the own station, which turns on for one scan upon completion of the instruction. When the instruction completes with an error, (d)+1 also turns on.	—	Bit	ANYBIT_ARRAY (Number of elements: 2)
EN	Execution condition	—	Bit	BOOL
ENO	Execution result	—	Bit	BOOL

*1 When specifying setting data by using a label, define an array to secure enough operation area and specify an element of the array label.

■Applicable devices

Operand		Bit		Word			Double word		Indirect specification	Constant			Others	
		X, Y, M, L, SM, F, B, SB, FX, FY	J□□	T, ST, C, D, W, SD, SW, FD, R, ZR, RD	U□\G□, J□\□, U3E□\□(H)G□	Z	LT, LST, LC	LZ		K, H, E, \$	J, U			
(J/U)	J(P).RIW T	—	—	—	—	—	—	—	—	—	—	—	○	—
	G(P).RIW T	—	—	○	—	—	—	—	○	○	—	—	—	○
(s1)		—	—	○*2	—	—	—	—	○	—	—	—	—	—
(s2)		—	—	○*2	—	—	—	—	○	—	—	—	—	—
(d)		○*1	—	○*3	—	—	—	—	—	—	—	—	—	—

*1 FX and FY cannot be used.

*2 FD cannot be used.

*3 T, ST, C, and FD cannot be used.

■Control data

Operand: (s1)				
Device	Item	Description	Setting range	Set by
+0	Completion status	The completion status is stored upon completion of the instruction. • 0: Normal • Other than 0: Error (error code)	—	System
+1	Target station number	Specifies the station number of the target station.	0 to 120	User
+2	Access/attribute code	Specify the access code and attribute code of the device to be written. <div style="display: flex; align-items: center; gap: 10px;"> b15 ... b8 b7 ... b0 </div> <div style="border: 1px solid black; width: 100%; height: 15px; margin-top: 5px;"></div> <ul style="list-style-type: none"> • b8 to b15: Access code • b0 to b7: Attribute code 	Refer to "Access/attribute code."	User
+3	Device number	Specify the start number of the device to be written.	Within device range	User
+4	Number of write points	Specify the number of data in units of words to read from the device.	1 to 480	User

■ Access/attribute code

Device category*1	Name	Date type		Unit	Access code*2	Attribute code*2
		Bit	Word			
Input relay	X	○	—	Hexadecimal	01H	05H
Output relay	Y	○	—	Hexadecimal	02H	05H
Internal relay	M	○	—	Decimal	03H	05H
Latch relay	L	○	—	Decimal	83H	05H
Link relay	B	○	—	Hexadecimal	23H	05H
Timer (contact)	T	○	—	Decimal	09H	05H
Timer (coil)	T	○	—	Decimal	0AH	05H
Timer (current value)	T	—	○	Decimal	0CH	05H
Retentive timer (contact)	ST	○	—	Decimal	89H	05H
Retentive timer (coil)	ST	○	—	Decimal	8AH	05H
Retentive timer (current value)	ST	—	○	Decimal	8CH	05H
Counter (contact)	C	○	—	Decimal	11H	05H
Counter (coil)	C	○	—	Decimal	12H	05H
Counter (current value)	C	—	○	Decimal	14H	05H
Data register*3	D	—	○	Decimal	04H	05H
Link register*3	W	—	○	Hexadecimal	24H	05H
File register	R	—	○	Decimal	84H	05H
Link special relay	SB	○	—	Hexadecimal	63H	05H
Link special register	SW	—	○	Hexadecimal	64H	05H
Special relay	SM	○	—	Decimal	43H	05H
Special register	SD	—	○	Decimal	44H	05H

*1 Any device other than the above cannot be accessed. To access a bit device, specify 0 or a multiple of 16.

*2 When the target station is other than the CC-Link IE Controller Network module and CC-Link IE Field Network master/local module, refer to the manual of the target station.

*3 D65536 and the subsequent extended data registers and of W10000 and the subsequent extended link registers cannot be specified.

Point

The RIWT instruction can set the arrival monitoring time and the number of resends in the following link special registers (SW).

- RIRD/RIWT instruction: Arrival monitoring time (SW0009)
- RIRD/RIWT instruction: Number of resends (SW000B)

When "RIRD/RIWT instruction: Number of resends (SW000B)" is set, the time taken for the RIWT instruction to be completed with an error is determined by the following.

(RIRD/RIWT instruction: Number of resends + 1) × RIRD/RIWT instruction: Arrival monitoring time

However, if the target station (relay source station when addressed to another network) has been disconnected at the time of RIWT instruction execution, no retry is executed. If the RIWT instruction is completed with an error, re-execute the RIWT instruction after the target station (relay source station when addressed to another network) returns.

If an error (error code: E504H) occurs in CC-Link IE Controller Network, a retry cannot be performed. Wait until the instruction completes with an error, and execute the RIWT instruction again.

Processing details

- These instructions read the number of words of data specified by (s1)+4 from the start device of the own station specified by (s2), and write the data in the device in the target station specified by (s1)+2 and (s1)+3. Specify the target station in (s1)+1. Upon completion of writing the data, the completion device specified by (d) turns on.

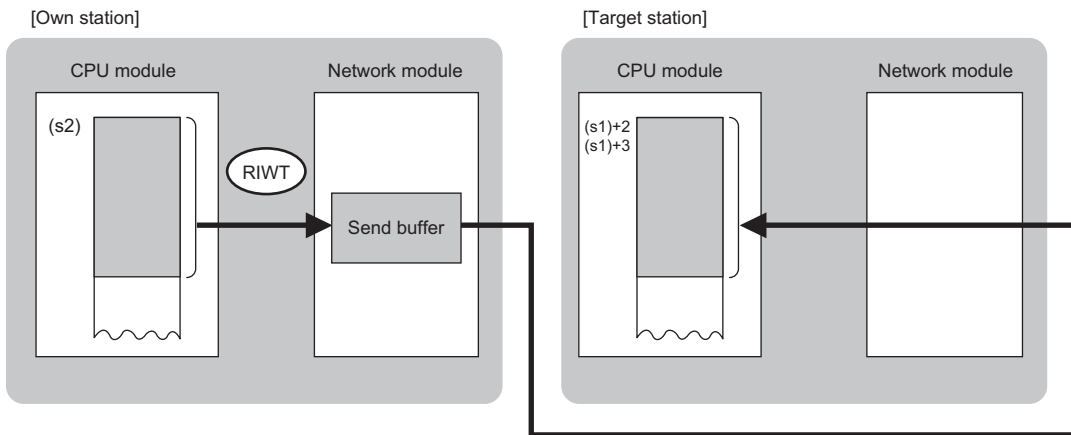

- The execution status and the completion status of the RIWT instruction can be checked with the completion device (d) and the completion status indication device (d)+1.

- Completion device (d)

This device turns on during END processing of the scan where the RIWT instruction completes, and turns off during the next END processing.

- Completion status indication device (d)+1

This device turns on or off depending on the completion status of the RIWT instruction.

When completed successfully: The device remains off.

When completed with an error: The device turns on during END processing of the scan where the RIWT instruction completes, and turns off during the next END processing.

- The following figure shows the execution timing of the RIWT instruction.

- When completed successfully

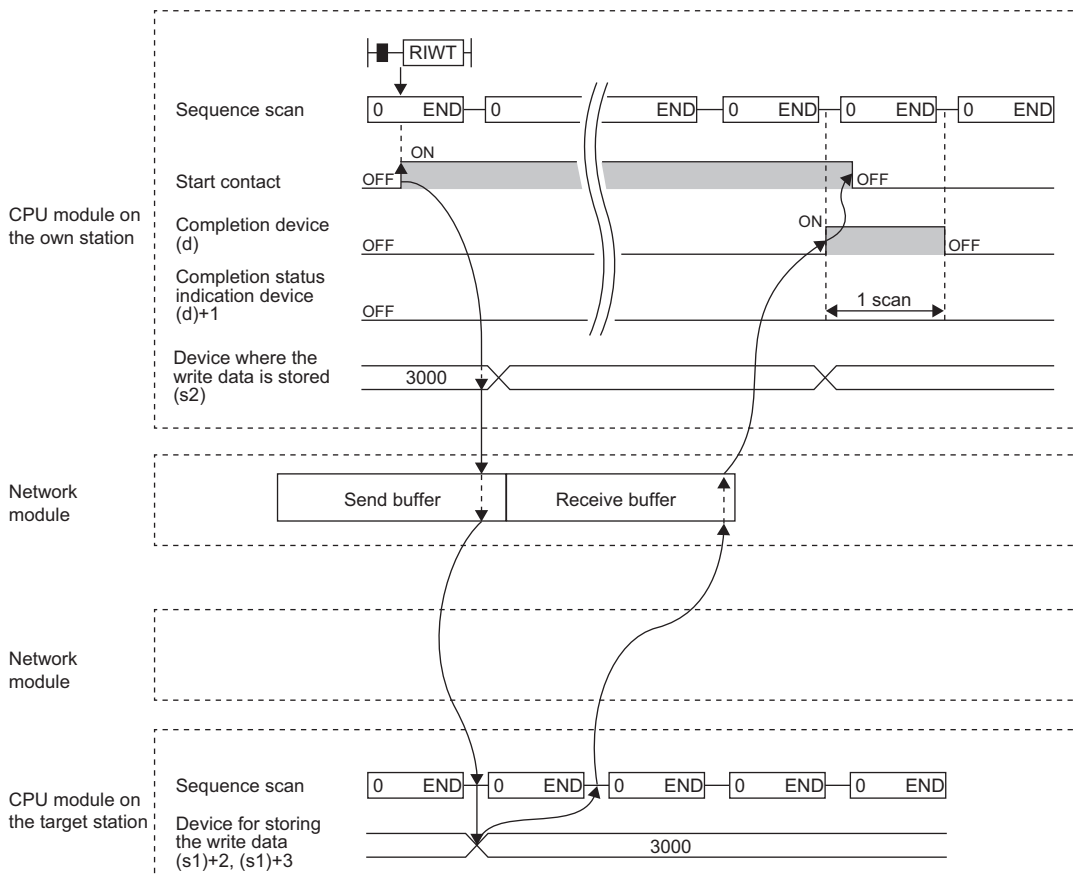

- When completed with an error

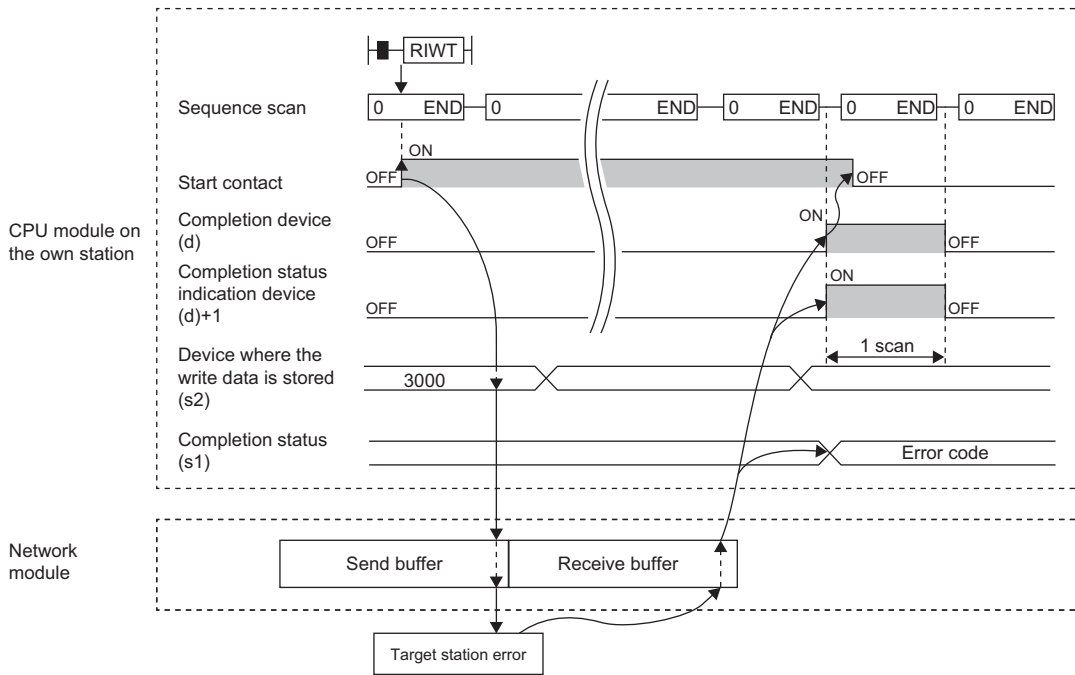

Operation error

Error code ((s1)+0)	Description
4000H to 4FFFH	MELSEC iQ-R CPU Module User's Manual (Application)
D000H to DFFFH	MELSEC iQ-R CC-Link IE Field Network User's Manual (Application)
E000H to EFFFH	MELSEC iQ-R CC-Link IE Controller Network User's Manual (Application)

4 Ethernet INSTRUCTIONS

Point

This chapter describes the instructions used commonly by MELSEC iQ-R series modules. For the instructions when MELSEC-Q series modules are used, refer to the manuals for each module used and create programs. For precautions when using modules, refer to the following.

MELSEC iQ-R Module Configuration Manual

4.1 Open/Close Processing Instructions

Opening a connection

GP.CONOPEN



This instruction establishes (opens) a connection with an external device for data communication.

Ladder	ST
	<pre>ENO:=GP_CONOPEN(EN,U,s1,s2,d);</pre>

FBD/LD

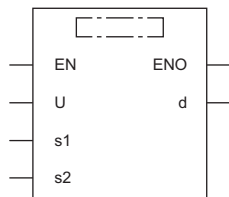

Execution condition

Instruction	Execution condition
GP.CONOPEN	

Setting data

■Description, range, data type

Operand	Description	Range	Data type	Data type (label)
(U)	Start I/O number (first three digits in four-digit hexadecimal representation) of own station or own node	00H to FEH	16-bit unsigned binary	ANY16
(s1)	Connection No.	1 to 128 (1 to 16: Port 1 fixed buffer communications, 17 to 64: Port 1 socket communications, 65 to 128: Port 2 socket communications)	16-bit unsigned binary	ANY16
(s2)	Start device of the own station where control data is stored	Refer to the control data.	Device name	ANY16 ^{*1}
(d)	Device of the own station, which turns on for one scan upon completion of the instruction. When the instruction completes with an error, (d)+1 also turns on.	—	Bit	ANYBIT_ARRAY (Number of elements: 2)
EN	Execution condition	—	Bit	BOOL
ENO	Execution result	—	Bit	BOOL

*1 When specifying setting data by using a label, define an array to secure enough operation area and specify an element of the array label.

■Applicable devices

Operand	Bit		Word			Double word		Indirect specification	Constant			Others (U)
	X, Y, M, L, SM, F, B, SB, FX, FY	J□□□	T, ST, C, D, W, SD, SW, FD, R, ZR, RD	U□□G□, J□□□, U3E□□(H)G□	Z	LT, LST, LC	LZ		K, H	E	\$	
(U)	—	—	○	—	—	—	○	○	—	—	○	
(s1)	○ ^{*1}	—	○ ^{*2}	—	—	—	○	○	—	—	—	
(s2)	—	—	○ ^{*2}	—	—	—	○	—	—	—	—	
(d)	○ ^{*1}	—	○ ^{*3}	—	—	—	—	—	—	—	—	

*1 FX and FY cannot be used.

*2 FD cannot be used.

*3 T, ST, C, and FD cannot be used.

Control data

Operand: (s2)																					
Device	Item	Description	Setting range	Set by																	
+0	Execution type/End type	<p>b15 ... b8 ... b0</p> <table border="1" style="width: 100%; text-align: center;"> <tr> <td style="width: 33%;">0</td> <td style="width: 33%;">(1)</td> <td style="width: 33%;">0</td> </tr> </table> <p>(1) Execution type*1 Specify whether to use the parameter value set by the engineering tool or the value set in (s2)+4 to (s2)+14 of control data for opening a connection.</p> <ul style="list-style-type: none"> • 0: Performs open processing according to the "external device connection configuration" set by the engineering tool. • 1: Performs open processing according to the setting in (s2)+4 to (s2)+14 of control data. <p>If the GP.CONOPEN instruction is executed by setting the value for the external device connection configuration of the engineering tool and also setting device (s2)+0 to 1, the instruction performs open processing according to the value set in its control data.</p> <p>Even if a value is set in (s2)+4 and later after setting (s2)+0 to 0, the value is ignored.</p>	0	(1)	0	0000H 0100H	User														
0	(1)	0																			
+1	Completion status	<p>The completion status is stored upon completion of the instruction.</p> <ul style="list-style-type: none"> • 0: Completed successfully • Other than 0: Completed with an error (error code) 	—	System																	
+2	System area	—	—	—																	
+3	System area	—	—	—																	
+4	Application setting area	<p>Specify the application of a connection.</p> <p>■Fixed buffer communications</p> <p>b15 ... b12 b11 b10 b9 b8 b7 b6 b5 b4 b3 b2 b1 b0</p> <table border="1" style="width: 100%; text-align: center;"> <tr> <td style="width: 12.5%;">0</td> <td style="width: 6.25%;">(8)</td> <td style="width: 6.25%;">(7)</td> <td style="width: 6.25%;">(6)</td> <td style="width: 6.25%;">(5)</td> <td style="width: 6.25%;">(4)</td> <td style="width: 6.25%;">(3)</td> <td style="width: 6.25%;">0</td> <td style="width: 6.25%;">(2)</td> <td style="width: 6.25%;">(1)</td> </tr> </table> <p>(1) Application of fixed buffer (b0)</p> <ul style="list-style-type: none"> • 0: For sending • 1: For receiving <p>(2) Communication code (b1)</p> <ul style="list-style-type: none"> • 0: Binary code • 1: ASCII code <p>(3) Online program change (b3)</p> <ul style="list-style-type: none"> • 0: Disable • 1: Enable <p>(4) Pairing open (b4)</p> <ul style="list-style-type: none"> • 0: Disable pairing open. • 1: Enable pairing open.*2 <p>(5) Communication method (protocol) (b5)</p> <ul style="list-style-type: none"> • 0: TCP/IP • 1: UDP/IP <p>(6) Fixed buffer communications with/without procedure (b6 and b7)</p> <ul style="list-style-type: none"> • 00: With procedure • 01: Without procedure <p>(7) Alive check (b8 and b9)</p> <ul style="list-style-type: none"> • 00: KeepAlive*4 • 01: Alive check with UDP*5 • 10: Disable the alive check. <p>(8) Opening method (b10 and b11)</p> <ul style="list-style-type: none"> • 00: Active open or UDP/IP • 10: Unpassive open • 11: Fullpassive open <p>■Socket communications</p> <p>b15 ... b12 b11 b10 b9 ... b6 b5 b4 b3 b2 ... b0</p> <table border="1" style="width: 100%; text-align: center;"> <tr> <td style="width: 12.5%;">0</td> <td style="width: 6.25%;">(3)</td> <td style="width: 6.25%;">0</td> <td style="width: 6.25%;">(2)</td> <td style="width: 6.25%;">0</td> <td style="width: 6.25%;">(1)</td> <td style="width: 6.25%;">0</td> </tr> </table> <p>(1) Online program change (b3)</p> <ul style="list-style-type: none"> • 0: Disable • 1: Enable <p>(2) Communication method (protocol) (b5)</p> <ul style="list-style-type: none"> • 0: TCP/IP • 1: UDP/IP <p>(3) Opening method (b10 and b11)</p> <ul style="list-style-type: none"> • 00: Active open or UDP/IP • 10: Unpassive open • 11: Fullpassive open 	0	(8)	(7)	(6)	(5)	(4)	(3)	0	(2)	(1)	0	(3)	0	(2)	0	(1)	0	Left	User
0	(8)	(7)	(6)	(5)	(4)	(3)	0	(2)	(1)												
0	(3)	0	(2)	0	(1)	0															

Operand: (s2)				
Device	Item	Description	Setting range	Set by
+5	Own node port number	Specify the port number of the own node. (Port numbers 5000 to 5009 is reserved for the system and cannot be used.)	1024 to 4999 5010 to 65534 (0400H to 1387H, 1392H to FFFEH)	User
+6 +7	IP address of external device ^{*6}	Specify the IP address (IPv4) of an external device. • The IP address is stored in (s2)+6 and (s2)+7. • To enable broadcast, store FFFFFFFFH.	0000001H to FFFFFFFHH	User
+8 to +13	System area	—	—	—
+14	Destination port number ^{*6}	Specify the destination port number. When receiving data from all port numbers, store FFFFH. ^{*3}	1024 to 65535 (0400H to FFFFH)	User

*1 When the execution type is set to 0, the device areas in (s2)+4 to (s2)+14 are used by the system and the user must not use the areas.

*2 This item can be set when the connection number in (s1) is one from 1 to 7 and 9 to 15.

*3 This specification is enabled when UDP/IP is specified for the communication method (protocol).

Data cannot be sent through the connection for which 65535 (FFFFH) is specified. Specify a value from 1 to 65534 to send data.

*4 This specification is enabled when TCP/IP is specified for the communication method (protocol).

*5 This specification is enabled when UDP/IP is specified for the communication method (protocol).

*6 Settings are ignored if the open method (bits 10 and 11) specified by (s2)+4 is "10: Unpassive open".



Processing details

The GP.CONOPEN instruction is used for socket communications or fixed buffer communications.

For the combinations of available settings for connection opening, refer to the following.

 MELSEC iQ-R Ethernet User's Manual (Application)

Operation error

Error code ((s2)+1)	Description
C000H to CFBFH	 MELSEC iQ-R Ethernet User's Manual (Application)
CFC0H to CFFFH	 MELSEC iQ-R CPU Module User's Manual (Application)

Point

The following figure shows an IP address setting example.

Example: IP address "10.97.24.200 (0A.61.18.C8)"

[Program example]

[Program example]

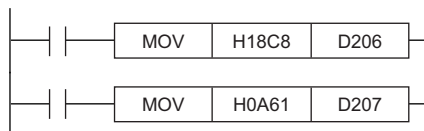

or



[Execution result]

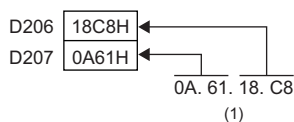

(1) The data is stored from the lower byte.

Closing a connection

GP.CONCLOSE

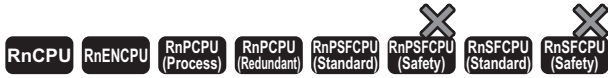

This instruction disconnects (closes) the connection from the external device during data communication.

Ladder	ST
	<pre>ENO:=GP_CONCLOSE(EN,U,s1,s2,d);</pre>

FBD/LD

Execution condition

Instruction	Execution condition
GP.CONCLOSE	

Setting data

Description, range, data type

Operand	Description	Range	Data type	Data type (label)
(U)	Start I/O number (first three digits in four-digit hexadecimal representation) of own station or own node	00H to FEH	16-bit unsigned binary	ANY16
(s1)	Connection No.	1 to 128 (1 to 16: Port 1 fixed buffer communications, 17 to 64: Port 1 socket communications, 65 to 128: Port 2 socket communications)	16-bit unsigned binary	ANY16
(s2)	Start device of the own station where control data is stored	Refer to the control data.	Device name	ANY16 ^{*1}
(d)	Device of the own station, which turns on for one scan upon completion of the instruction. When the instruction completes with an error, (d)+1 also turns on.	—	Bit	ANYBIT_ARRAY (Number of elements: 2)
EN	Execution condition	—	Bit	BOOL
ENO	Execution result	—	Bit	BOOL

*1 When specifying setting data by using a label, define an array to secure enough operation area and specify an element of the array label.

■Applicable devices

Operand	Bit		Word			Double word		Indirect specification	Constant			Others (U)
	X, Y, M, L, SM, F, B, SB, FX, FY	J□□	T, ST, C, D, W, SD, SW, FD, R, ZR, RD	U□V□, J□□, U3E□(H)G□	Z	LT, LST, LC	LZ		K, H	E	\$	
(U)	—	—	○	—	—	—	○	○	—	—	○	
(s1)	○*1	—	○*2	—	—	—	○	○	—	—	—	
(s2)	—	—	○*2	—	—	—	○	—	—	—	—	
(d)	○*1	—	○*3	—	—	—	—	—	—	—	—	

*1 FX and FY cannot be used.

*2 FD cannot be used.

*3 T, ST, C, and FD cannot be used.



■Control data

Operand: (s2)				
Device	Item	Description	Setting range	Set by
+0	System area	—	—	—
+1	Completion status	The completion status is stored upon completion of the instruction. <ul style="list-style-type: none"> • 0: Completed successfully • Other than 0: Completed with an error (error code) 	—	System

Processing details

The GP.CONCLOSE instruction is used for socket communications or fixed buffer communications.

Operation error

Error code ((s2)+1)	Description
C000H to CFBFH	 MELSEC iQ-R Ethernet User's Manual (Application)
CFC0H to CFFFH	 MELSEC iQ-R CPU Module User's Manual (Application)

Opening a connection

GP.OPEN, ZP.OPEN

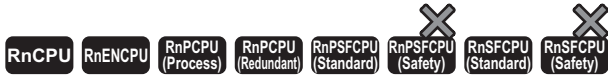

This instruction establishes (opens) a connection with an external device for data communication.

Ladder	ST
	<pre> ENO:=GP_OPEN(EN,U,s1,s2,d); ENO:=ZP_OPEN(EN,U,s1,s2,d); </pre>

FBD/LD

Execution condition

Instruction	Execution condition
GP.OPEN ZP.OPEN	

Setting data

Description, range, data type

Operand	Description	Range	Data type	Data type (label)
(U)	GP.OPEN Start I/O number (first three digits in four-digit hexadecimal representation) of own station or own node	00H to FEH	16-bit unsigned binary	ANY16
	ZP.OPEN Start I/O number (first three digits in four-digit hexadecimal representation) of own station or own node	00H to FEH	String	ANY16_OR_STRING_SINGLE
(s1)	Connection No.	1 to 16	16-bit unsigned binary	ANY16
(s2)	Start device of the own station where control data is stored	Refer to the control data.	Device name	ANY16 ^{*1}
(d)	Device of the own station, which turns on for one scan upon completion of the instruction. When the instruction completes with an error, (d)+1 also turns on.	—	Bit	ANYBIT_ARRAY (Number of elements: 2)
EN	Execution condition	—	Bit	BOOL
ENO	Execution result	—	Bit	BOOL

*1 When specifying setting data by using a label, define an array to secure enough operation area and specify an element of the array label.

■Applicable devices

Operand	Bit		Word			Double word		Indirect specification	Constant			Others (U)
	X, Y, M, L, SM, F, B, SB, FX, FY	J□□	T, ST, C, D, W, SD, SW, FD, R, ZR, RD	U□\G□, J□\□, U3E□\(\H)G□	Z	LT, LST, LC	LZ		K, H	E	\$	
(U)	GP.OPEN	—	—	○	—	—	—	○	○	—	—	○
	ZP.OPEN	—	—	○	—	—	—	○	—	—	○	○
(s1)		○*1	—	○*2	—	—	—	○	○	—	—	—
(s2)		—	—	○*2	—	—	—	○	—	—	—	—
(d)		○*1	—	○*3	—	—	—	—	—	—	—	—

*1 FX and FY cannot be used.

*2 FD cannot be used.

*3 T, ST, C, and FD cannot be used.

Control data

Operand: (s2)														
Device	Item	Description	Setting range	Set by										
+0	Execution type/End type	Specify whether to use the parameter value set by the engineering tool or the value set in (s2)+2 to (s2)+6 of control data for opening a connection. <ul style="list-style-type: none"> • 0000H: Performs open processing according to the "external device connection configuration" set by the engineering tool. • 8000H: Performs open processing according to the setting in (s2)+2 to (s2)+6 of control data. 	0000H 8000H	User										
+1	Completion status	The completion status is stored upon completion of the instruction. <ul style="list-style-type: none"> • 0: Completed successfully • Other than 0: Completed with an error (error code) 	—	System										
+2	Application setting area	Specify the application of a connection. <table border="1" style="margin-left: 20px;"> <tr> <td>b15b14 b13</td> <td>...</td> <td>b11 b10 b9 b8 b7 b6</td> <td>...</td> <td>b2 b1 b0</td> </tr> <tr> <td>(6)</td> <td>0</td> <td>(5) (4) (3)</td> <td>0</td> <td>(2) (1)</td> </tr> </table> <p>(1) Application of fixed buffer (b0)</p> <ul style="list-style-type: none"> • 0: For sending • 1: For receiving <p>(2) Target station alive check (b1)</p> <ul style="list-style-type: none"> • 0: Disable the alive check. • 1: Alive check^{*1} <p>(3) Pairing open (b7)</p> <ul style="list-style-type: none"> • 0: Disable pairing open. • 1: Enable pairing open.^{*2} <p>(4) Protocol (b8)</p> <ul style="list-style-type: none"> • 0: TCP/IP • 1: UDP/IP <p>(5) Fixed buffer communications with/without procedure (b9 and b10)</p> <ul style="list-style-type: none"> • 00: With procedure • 01: Without procedure • 10: Communication protocol <p>(6) Opening method (b14 and b15)</p> <ul style="list-style-type: none"> • 00: Active open or UDP/IP • 10: Unpassive open • 11: Fullpassive open 	b15b14 b13	...	b11 b10 b9 b8 b7 b6	...	b2 b1 b0	(6)	0	(5) (4) (3)	0	(2) (1)	Left	User
b15b14 b13	...	b11 b10 b9 b8 b7 b6	...	b2 b1 b0										
(6)	0	(5) (4) (3)	0	(2) (1)										
+3	Own station port number.	Specify the port number of the own station. (Port numbers 5000 to 5009 is reserved for the system and cannot be used.)	1024 to 4999, 5010 to 65534 (0400H to 1387H, 1392H to FFFE H)	User										
+4 to +5	IP address of external device ^{*3}	Specify the IP address (IPv4) of an external device. <ul style="list-style-type: none"> • The IP address is stored in (s2)+4 and (s2)+5. • To enable broadcast, specify FFFFFFFFH. 	00000001H to FFFFFFF H	User										
+6	Destination port number ^{*3}	Specify the destination port number. When receiving data from all port numbers, specify FFFFH.	1 to 65534, 65535 (0001H to FFFE H, FFFFH)	User										
+7 to +9	System area	—	—	—										

*1 When the TCP/IP protocol is used, the alive check method is fixed to KeepAlive. (When UDP/IP is used, it is fixed to Ping.)

*2 This item can be set when the connection number set in (s1) is one from 1 to 7 and 9 to 15.

*3 Settings are ignored if the open method (bits 14 and 15) specified by (s2)+2 is "10: Unpassive open".

Processing details

- These instructions open the connection specified by (s1) of the module specified by (U).
- The selection of the setting value used for open processing is specified by (s2)+0. (Specify whether to use the parameter value set by the engineering tool or the value set in (s2)+2 to (s2)+16 of control data.)
- The execution status and the completion status of the OPEN instruction can be checked with the completion device (d) and the completion status indication device (d)+1.

- Completion device (d)

This device turns on during END processing of the scan where the OPEN instruction completes, and turns off during the next END processing.

- Completion status indication device (d)+1

This device turns on or off depending on the completion status of the OPEN instruction.

When completed successfully: The device remains off.

When completed with an error: The device turns on during END processing of the scan where the OPEN instruction completes, and turns off during the next END processing.

- The following figure shows the operation at completion of the OPEN instruction.

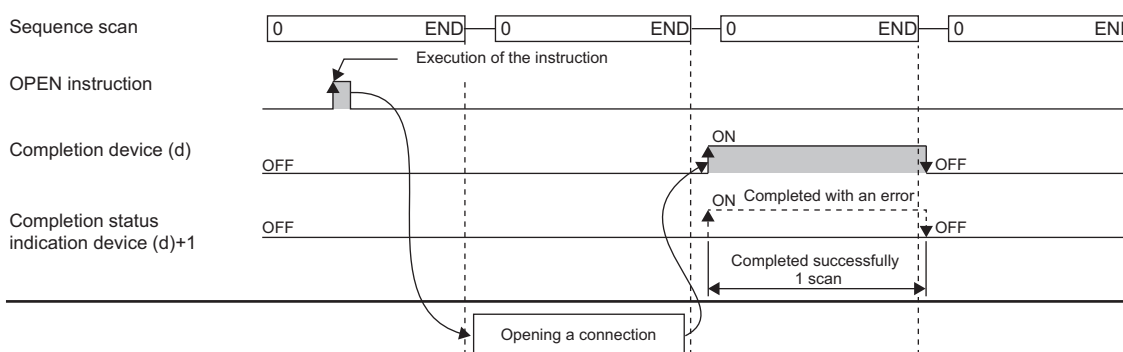

- The OPEN instruction is executed on the rising edge (off to on) of the open command.

Precautions

For the same connection, do not perform open and close processing using the OPEN and CLOSE instructions concurrently with open and close processing using other means. Concurrent use results in a malfunction.

Operation error

Error code ((s2)+1)	Description
C000H to CFBFH	MELSEC iQ-R Ethernet User's Manual (Application)
CFC0H to CFFFH	MELSEC iQ-R CPU Module User's Manual (Application)

Restriction

- The communication means of the target connection is fixed buffer communications (with procedure), fixed buffer communications (without procedure), or predefined protocol. Make settings in (b9, b10) (fixed buffer communications with/without procedure) of (s2)+2 in control data.
- When the protocol is set to TCP/IP, the alive check method is fixed to KeepAlive.
- The connection numbers that can be specified range from 1 to 16. Connection number 17 and after cannot be specified.
- If no parameter data is set in "external device connection configuration" of the engineering tool, the communication data code becomes "binary". If one or more parameter data are set, the instruction follows the value set in "Communication data code".
- If no parameter data is set in "external device connection configuration" of the engineering tool, the opening method becomes "Do not open with the program". If one or more parameter data are set, the instruction follows the value set in "Opening method".

Closing a connection

GP.CLOSE, ZP.CLOSE



These instructions disconnect (close) the connection from the external device during data communication.

Ladder	ST
<p>The diagram shows a normally open contact with parameters (U), (s1), (s2), and (d) connected to a coil.</p>	<pre>ENO:=GP_CLOSE(EN,U,s1,s2,d); ENO:=ZP_CLOSE(EN,U,s1,s2,d);</pre>

FBD/LD

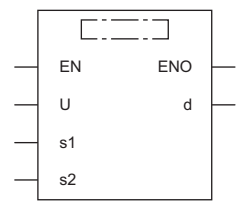

Execution condition

Instruction	Execution condition
GP.CLOSE ZP.CLOSE	

Setting data

Description, range, data type

Operand	Description	Range	Data type	Data type (label)
(U)	GP.CLOSE Start I/O number (first three digits in four-digit hexadecimal representation) of own station or own node	00H to FEH	16-bit unsigned binary	ANY16
	ZP.CLOSE Start I/O number (first three digits in four-digit hexadecimal representation) of own station or own node	00H to FEH	String	ANY16_OR_STRING_SINGLE
(s1)	Connection No.	1 to 16	16-bit unsigned binary	ANY16
(s2)	Start device of the own station where control data is stored	Refer to the control data.	Device name	ANY16 ^{*1}
(d)	Device of the own station, which turns on for one scan upon completion of the instruction. When the instruction completes with an error, (d)+1 also turns on.	—	Bit	ANYBIT_ARRAY (Number of elements: 2)
EN	Execution condition	—	Bit	BOOL
ENO	Execution result	—	Bit	BOOL

*1 When specifying setting data by using a label, define an array to secure enough operation area and specify an element of the array label.

■Applicable devices

Operand	Bit			Word			Double word		Indirect specification	Constant			Others (U)
	X, Y, M, L, SM, F, B, SB, FX, FY	J□□		T, ST, C, D, W, SD, SW, FD, R, ZR, RD	U□\G□, J□□, U3E□(H)G□	Z	LT, LST, LC	LZ		K, H	E	\$	
(U)	GP.CLOSE	—	—	○	—	—	—	—	○	○	—	—	○
	ZP.CLOSE	—	—	○	—	—	—	—	○	—	—	○	○
(s1)		○*1	—	○*2	—	—	—	—	○	○	—	—	—
(s2)		—	—	○*2	—	—	—	—	○	—	—	—	—
(d1)		○*1	—	○*3	—	—	—	—	—	—	—	—	—

*1 FX and FY cannot be used.

*2 FD cannot be used.

*3 T, ST, C, and FD cannot be used.

■Control data

Operand: (s2)				
Device	Item	Description	Setting range	Set by
+0	System area	—	—	—
+1	Completion status	The completion status is stored upon completion of the instruction. • 0: Completed successfully • Other than 0: Completed with an error (error code)	—	System

Processing details

- These instructions close the connection specified by (s1) of the module specified by (U).
- The execution status and the completion status of the CLOSE instruction can be checked with the completion device (d) and the completion status indication device (d)+1.

- Completion device (d)

This device turns on during END processing of the scan where the CLOSE instruction completes, and turns off during the next END processing.

- Completion status indication device (d)+1

This device turns on or off depending on the completion status of the CLOSE instruction.

When completed successfully: The device remains off.

When completed with an error: The device turns on during END processing of the scan where the CLOSE instruction completes, and turns off during the next END processing.

- The following figure shows the operation at completion of the CLOSE instruction.

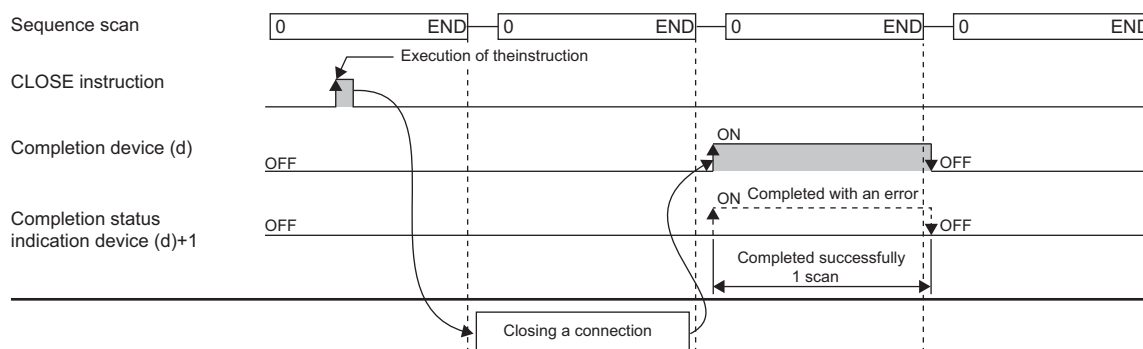



- The CLOSE instruction is executed on the rising edge (off to on) of the close command.

Precautions

- For the same connection, do not perform open and close processing using the OPEN and CLOSE instructions concurrently with open and close processing using other means. Concurrent use results in a malfunction.
- If a connection for which the OPEN instruction is in execution is specified in TCP Unpassive/Fullpassive open mode, an error (C1B2H: OPEN/CLOSE instruction is in execution for the specified connection) occurs.

Operation error

Error code ((s2)+1)	Description
C000H to CFBFH	 MELSEC iQ-R Ethernet User's Manual (Application)
CFC0H to CFFFH	 MELSEC iQ-R CPU Module User's Manual (Application)

4.2 Socket Communications Instructions

Reading receive data

GP.SOCRVCV

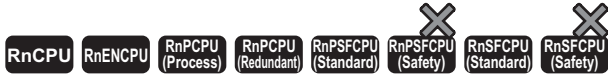

This instruction reads receive data from the external device through socket communications.

Ladder	ST
	<pre>ENO:=GP_SOCRVCV(EN,U,s1,s2,d1,d2);</pre>

FBD/LD

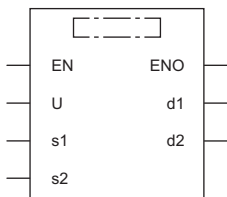

Execution condition

Instruction	Execution condition
GP.SOCRVCV	

Setting data

Description, range, data type

Operand	Description	Range	Data type	Data type (label)
(U)	Start I/O number (first three digits in four-digit hexadecimal representation) of own station or own node	00H to FEH	16-bit unsigned binary	ANY16
(s1)	Connection No.	17 to 128 (17 to 64: Port 1 socket communications, 65 to 128: Port 2 socket communications)	16-bit unsigned binary	ANY16
(s2)	Start device of the own station where control data is stored	Refer to the control data.	Device name	ANY16 ^{*1}
(d1)	Own station start device for storing the receive data	—	Device name	ANY16 ^{*1}
(d2)	Device of the own station, which turns on for one scan upon completion of the instruction. When the instruction completes with an error, (d2)+1 also turns on.	—	Bit	ANYBIT_ARRAY (Number of elements: 2)
EN	Execution condition	—	Bit	BOOL
ENO	Execution result	—	Bit	BOOL

*1 When specifying setting data by using a label, define an array to secure enough operation area and specify an element of the array label.

■Applicable devices

Operand	Bit		Word			Double word		Indirect specification	Constant			Others (U)
	X, Y, M, L, SM, F, B, SB, FX, FY	J□□	T, ST, C, D, W, SD, SW, FD, R, ZR, RD	U□\G□, J□□, U3E□(H)G□	Z	LT, LST, LC	LZ		K, H	E	\$	
(U)	—	—	○	—	—	—	○	○	—	—	○	
(s1)	○*1	—	○*2	—	—	—	○	○	—	—	—	
(s2)	—	—	○*2	—	—	—	○	—	—	—	—	
(d1)	—	—	○*2	—	—	—	○	—	—	—	—	
(d2)	○*1	—	○*3	—	—	—	—	—	—	—	—	

*1 FX and FY cannot be used.

*2 FD cannot be used.

*3 T, ST, C, and FD cannot be used.

■Control data

Operand: (s2)				
Device	Item	Description	Setting range	Set by
+0	System area	—	—	—
+1	Completion status	The completion status is stored upon completion of the instruction. • 0: Completed successfully • Other than 0: Completed with an error (error code)	—	System



■Receive data

Operand: (d1)				
Device	Item	Description	Setting range	Set by
+0	Receive data length	The length of the data read from the socket communications receive data area is stored.	—	System
+1 to +□	Receive data	The data read from the socket communications receive data area is stored sequentially in ascending order of addresses.	—	System

Processing details

The GP.SOCRCV instruction is used for socket communications.

Operation error

Error code ((s2)+1)	Description
C000H to CFBFH	 MELSEC iQ-R Ethernet User's Manual (Application)
CFC0H to CFFFH	 MELSEC iQ-R CPU Module User's Manual (Application)

Reading receive data (for interrupt programs)

G.SOCRCVS

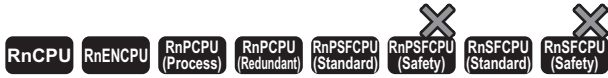

This instruction reads receive data from the external device through socket communications (for interrupt programs).

Ladder	ST
	<pre>ENO:=G_SOCRCVS(EN,U,s,d);</pre>

FBD/LD

Execution condition

Instruction	Execution condition
G.SOCRCVS	

Setting data

Description, range, data type

Operand	Description	Range	Data type	Data type (label)
(U)	Start I/O number (first three digits in four-digit hexadecimal representation) of own station or own node	00H to FEH	16-bit unsigned binary	ANY16
(s)	Connection No.	17 to 128 (17 to 64: Port 1 socket communications, 65 to 128: Port 2 socket communications)	16-bit unsigned binary	ANY16
(d)	Own station start device for storing the receive data	—	Device name	ANY16 ^{*1}
EN	Execution condition	—	Bit	BOOL
ENO	Execution result	—	Bit	BOOL

*1 When specifying setting data by using a label, define an array to secure enough operation area and specify an element of the array label.

Applicable devices

Operand	Bit	Word			Double word		Indirect specification	Constant			Others (U)
	X, Y, M, L, SM, F, B, SB, FX, FY	J□□	T, ST, C, D, W, SD, SW, FD, R, ZR, RD	U□\G□, J□□□, U3E□\□(H)G□	Z	LT, LST, LC		LZ	K	H	
(U)	—	—	○	—	—	—	○	○	—	—	○
(s)	○ ^{*1}	—	○ ^{*2}	—	—	—	○	○	—	—	—
(d)	—	—	○ ^{*2}	—	—	—	○	—	—	—	—

*1 FX and FY cannot be used.

*2 FD cannot be used.



■Receive data

Operand: (d)				
Device	Item	Description	Setting range	Set by
+0	Receive data length	The length of the data read from the socket communications receive data area is stored.	—	System
+1 to +□	Receive data	The data read from the socket communications receive data area is stored sequentially in ascending order of addresses.	—	System

Processing details

The G.SOCRCVS instruction is used for socket communications.

Operation error

Error code (SD0)	Description
C000H to CFBFH	 MELSEC IQ-R Ethernet User's Manual (Application)
CFC0H to CFFFH	 MELSEC IQ-R CPU Module User's Manual (Application)

Sending data

GP.SOCSND



This instruction sends data to the external device through socket communications.

Ladder	ST
	<pre>ENO:=GP_SOCSND(EN,U,s1,s2,s3,d);</pre>

FBD/LD

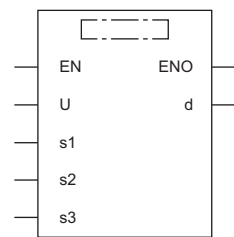

Execution condition

Instruction	Execution condition
GP.SOCSND	

Setting data

Description, range, data type

Operand	Description	Range	Data type	Data type (label)
(U)	Start I/O number (first three digits in four-digit hexadecimal representation) of own station or own node	00H to FEH	16-bit unsigned binary	ANY16
(s1)	Connection No.	17 to 128 (17 to 64: Port 1 socket communications, 65 to 128: Port 2 socket communications)	16-bit unsigned binary	ANY16
(s2)	Start device of the own station where control data is stored	Refer to the control data.	Device name	ANY16 ^{*1}
(s3)	Own station start device where send data is stored	—	Device name	ANY16 ^{*1}
(d)	Device of the own station, which turns on for one scan upon completion of the instruction. When the instruction completes with an error, (d)+1 also turns on.	—	Bit	ANYBIT_ARRAY (Number of elements: 2)
EN	Execution condition	—	Bit	BOOL
ENO	Execution result	—	Bit	BOOL

*1 When specifying setting data by using a label, define an array to secure enough operation area and specify an element of the array label.

■Applicable devices

Operand	Bit		Word			Double word		Indirect specification	Constant			Others (U)
	X, Y, M, L, SM, F, B, SB, FX, FY	J□□	T, ST, C, D, W, SD, SW, FD, R, ZR, RD	U□\G□, J□□, U3E□(H)G□	Z	LT, LST, LC	LZ		K, H	E	\$	
(U)	—	—	○	—	—	—	○	○	—	—	○	
(s1)	○*1	—	○*2	—	—	—	○	○	—	—	—	
(s2)	—	—	○*2	—	—	—	○	—	—	—	—	
(s3)	—	—	○*2	—	—	—	○	—	—	—	—	
(d)	○*1	—	○*3	—	—	—	—	—	—	—	—	

*1 FX and FY cannot be used.

*2 FD cannot be used.

*3 T, ST, C, and FD cannot be used.

■Control data

Operand: (s2)				
Device	Item	Description	Setting range	Set by
+0	System area	—	—	—
+1	Completion status	The completion status is stored upon completion of the instruction. • 0: Completed successfully • Other than 0: Completed with an error (error code)	—	System



■Send data

Operand: (s3)				
Device	Item	Description	Setting range	Set by
+0	Send data length	Specify the send data length. (Number of bytes)	1 to 10238	User
+1 to +□	Send data	Specify the send data.	—	User

Processing details

The GP.SOCSND instruction is used for socket communications.

Operation error

Error code ((s2)+1)	Description
C000H to CFBFH	 MELSEC iQ-R Ethernet User's Manual (Application)
CFC0H to CFFFH	 MELSEC iQ-R CPU Module User's Manual (Application)

4.3 Fixed Buffer Communications Instructions

Reading receive data

GP.BUFRCV, ZP.BUFRCV



These instructions read receive data from the external device through fixed buffer communications

Ladder	ST
	<pre>ENO:=GP_BUFRCV(EN,U,s1,s2,d1,d2); ENO:=ZP_BUFRCV(EN,U,s1,s2,d1,d2);</pre>

FBD/LD

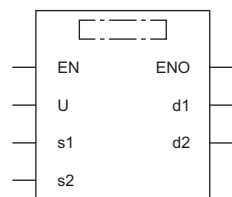

Execution condition

Instruction	Execution condition
GP.BUFRCV ZP.BUFRCV	

Setting data

Description, range, data type

Operand	Description	Range	Data type	Data type (label)
(U)	GP.BUFRCV Start I/O number (first three digits in four-digit hexadecimal representation) of own station or own node	00H to FEH	16-bit unsigned binary	ANY16
	ZP.BUFRCV Start I/O number (first three digits in four-digit hexadecimal representation) of own station or own node	00H to FEH	String	ANY16_OR_STRING_SINGLE
(s1)	Connection No.	1 to 16	16-bit unsigned binary	ANY16
(s2)	Start device of the own station where control data is stored	Refer to the control data.	Device name	ANY16 ^{*1}
(d1)	Own station start device for storing the receive data	—	Device name	ANY16 ^{*1}
(d2)	Device of the own station, which turns on for one scan upon completion of the instruction. When the instruction completes with an error, (d2)+1 also turns on.	—	Bit	ANYBIT_ARRAY (Number of elements: 2)
EN	Execution condition	—	Bit	BOOL
ENO	Execution result	—	Bit	BOOL

*1 When specifying setting data by using a label, define an array to secure enough operation area and specify an element of the array label.

■Applicable devices

Operand		Bit		Word			Double word		Indirect specification	Constant			Others (U)
		X, Y, M, L, SM, F, B, SB, FX, FY	J□□	T, ST, C, D, W, SD, SW, FD, R, ZR, RD	U□\G□, J□\□, U3E□\□(H)G□	Z	LT, LST, LC	LZ		K, H	E	\$	
(U)	GP.BUFRC V	—	—	○	—	—	—	—	○	○	—	—	○
	ZP.BUFRC V	—	—	○	—	—	—	—	○	—	—	○	○
(s1)		○*1	—	○*2	—	—	—	—	○	○	—	—	—
(s2)		—	—	○*2	—	—	—	—	○	—	—	—	—
(d1)		—	—	○*2	—	—	—	—	○	—	—	—	—
(d2)		○*1	—	○*3	—	—	—	—	—	—	—	—	—

*1 FX and FY cannot be used.

*2 FD cannot be used.

*3 T, ST, C, and FD cannot be used.

■Control data

Operand: (s2)				
Device	Item	Description	Setting range	Set by
+0	System area	—	—	—
+1	Completion status	The completion status is stored upon completion of the instruction. • 0: Completed successfully • Other than 0: Completed with an error (error code)	—	System

■Receive data

Operand: (d1)						
Device	Item	Description	Setting range	Set by		
+0	Receive data length	The length of the data read from the fixed buffer receive data area is stored. (The data length is represented in words or bytes according to the procedure of fixed buffer communications.)	With procedure (binary): Number of words	1 to 5113 (1 to 1017)*1	System	
			With procedure (ASCII): Number of words			1 to 2556 (1 to 508)*1
			Without procedure (binary): Number of bytes			1 to 10238 (1 to 2046)*1
+1 to +□	Receive data	The data read from the fixed buffer receive data areas is stored sequentially in ascending order of addresses.	—	System		

*1 This setting range is applicable when the network type is "Q-compatible Ethernet".

Processing details

- These instructions read the receive data (fixed buffer communications area) of the connection specified by (s1) of the module specified by (U). These instructions can be used only for the connections for which "fixed buffer communication (with/without procedure)" is set as the communication means.

[Reading receive data from the sending station to the own station]

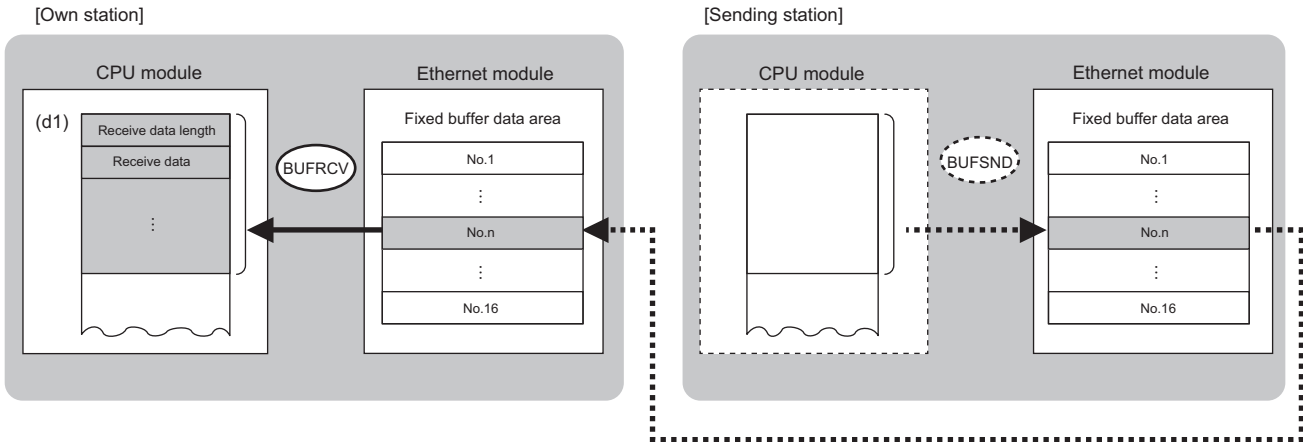

No.: Connection No.

- The execution status and the completion status of the BUFRCV instruction can be checked with the completion device (d2) and the completion status indication device (d2)+1.

- Completion device (d2)

This device turns on during END processing of the scan where the BUFRCV instruction completes, and turns off during the next END processing.

- Completion status indication device (d2)+1

This device turns on or off depending on the completion status of the BUFRCV instruction.

When completed successfully: The device remains off.

When completed with an error: The device turns on during END processing of the scan where the BUFRCV instruction completes, and turns off during the next END processing.

- The following figure shows the operation at completion of the BUFRCV instruction.

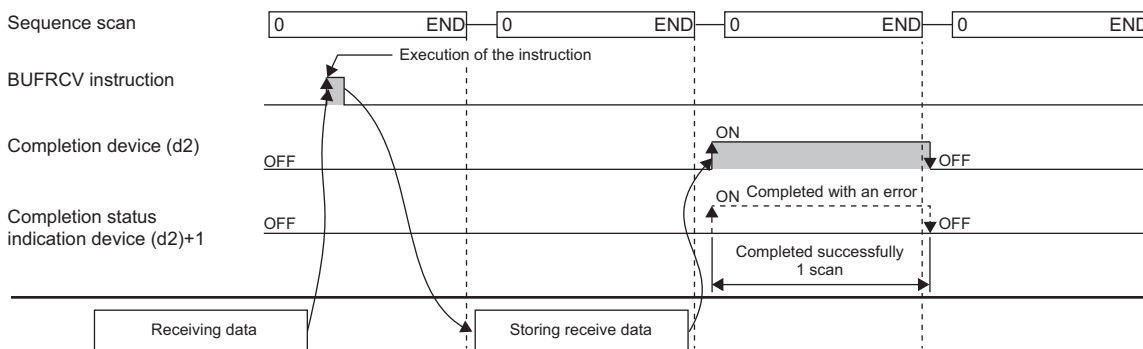

- The BUFRCV instruction is executed on the rising edge (off to on) of the socket/fixed buffer receive status signal (Un\G1900016 to Un\G1900023).

Restriction

When the BUFRCV instruction reads receive data from the same connection, it cannot be used in combination with the BUFRCVS instruction (for use in interrupt programs).

Operation error

Error code ((s2)+1)	Description
C000H to CBFH	📖 MELSEC iQ-R Ethernet User's Manual (Application)
CFC0H to CFFFH	📖 MELSEC iQ-R CPU Module User's Manual (Application)

Reading receive data (for interrupt programs)

G.BUFRCVS, Z.BUFRCVS

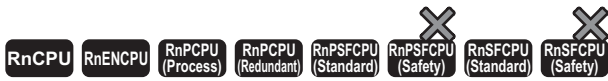

These instructions read receive data from the external device through fixed buffer communications (for interrupt programs).

Ladder	ST
	<pre>ENO:=G_BUFRCVS(EN,U,s,d); ENO:=Z_BUFRCVS(EN,U,s,d);</pre>

FBD/LD

Execution condition

Instruction	Execution condition
G.BUFRCVS Z.BUFRCVS	

Setting data

Description, range, data type

Operand	Description	Range	Data type	Data type (label)
(U)	GP.BUFRCVS Start I/O number (first three digits in four-digit hexadecimal representation) of own station or own node	00H to FEH	16-bit unsigned binary	ANY16
	ZP.BUFRCVS Start I/O number (first three digits in four-digit hexadecimal representation) of own station or own node	00H to FEH	String	ANY16_OR_STRING_SINGLE
(s)	Connection No.	1 to 16	16-bit unsigned binary	ANY16
(d)	Own station start device for storing the receive data	—	Device name	ANY16 ^{*1}
EN	Execution condition	—	Bit	BOOL
ENO	Execution result	—	Bit	BOOL

*1 When specifying setting data by using a label, define an array to secure enough operation area and specify an element of the array label.

Applicable devices

Operand	Bit X, Y, M, L, SM, F, B, SB, FX, FY	Word T, ST, C, D, W, SD, SW, FD, R, ZR, RD	Double word LT, LST, LZ	Indirect specification	Constant			Others (U)
					K, H	E	\$	
(U)	GP.BUFRCV S	—	—	—	—	—	—	—
	ZP.BUFRCV S	—	—	—	—	—	—	—
(s)	○ ^{*1}	—	○ ^{*2}	—	—	—	—	—
(d)	—	—	○ ^{*2}	—	—	—	—	—

*1 FX and FY cannot be used.

*2 FD cannot be used.

Receive data

Operand: (d)				
Device	Item	Description	Setting range	Set by
+0	Receive data length	The length of the data read from the fixed buffer receive data area is stored. (The data length is represented in words or bytes according to the procedure of fixed buffer communications.)	With procedure (binary): Number of words 1 to 5113 (1 to 1017)*1 With procedure (ASCII): Number of words 1 to 2556 (1 to 508)*1 Without procedure (binary): Number of bytes 1 to 10238 (1 to 2046)*1	System
+1 to +□	Receive data	The data read from the fixed buffer receive data areas is stored sequentially in ascending order of addresses.	—	System

*1 This setting range is applicable when the network type is "Q-compatible Ethernet".

Processing details

- These instructions read the receive data (fixed buffer communications area) of the connection specified by (s) of the module specified by (U). These instructions can be used only for the connections for which "fixed buffer communication (with/without procedure)" is set as the communication means.

[Reading receive data from the sending station to the own station]

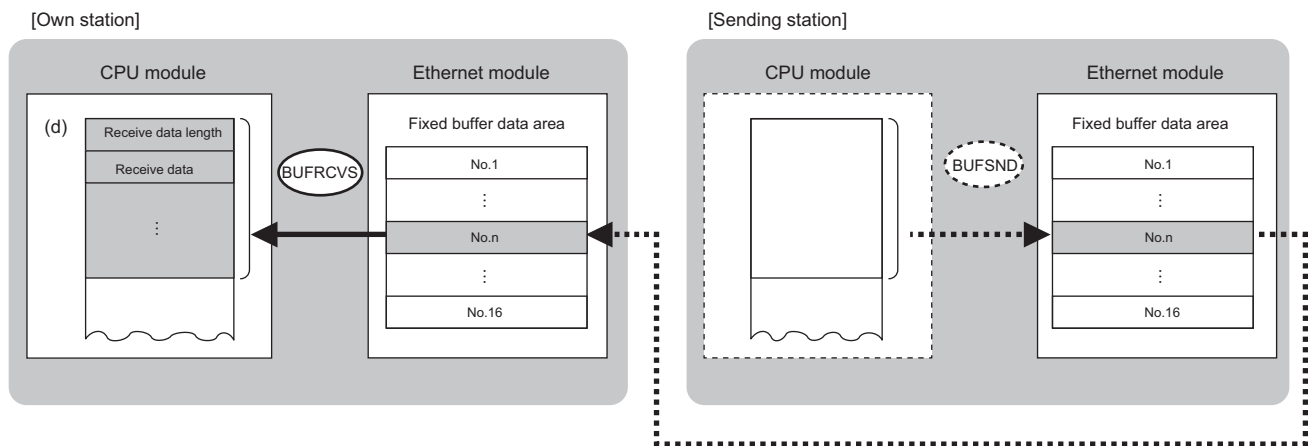

No.: Connection No.

- The BUFRCV instruction is used in interrupt programs and processing is completed in a single scan.

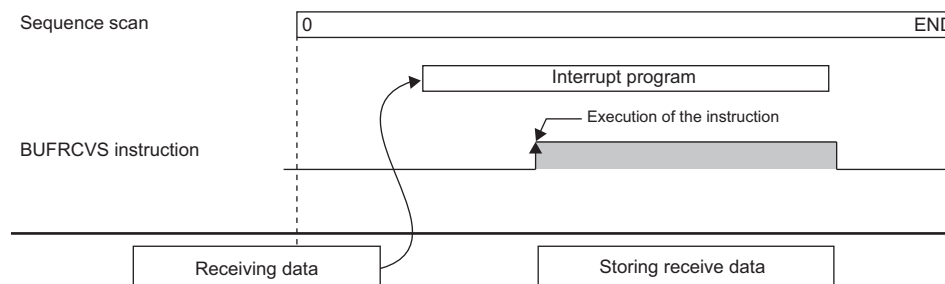

Restriction

When the BUFRCV instruction reads receive data from the same connection, it cannot be used in combination with the BUFRCV instruction.

Operation error

Error code (SD0)	Description
C000H to CFBFH	📖 MELSEC iQ-R Ethernet User's Manual (Application)
CFC0H to CFFFH	📖 MELSEC iQ-R CPU Module User's Manual (Application)

Sending data

GP.BUFSND, ZP.BUFSND

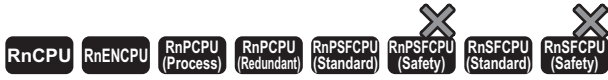

These instructions send data to the external device through fixed buffer communications.

Ladder	ST
	<pre>ENO:=GP_BUFSND(EN,U,s1,s2,s3,d); ENO:=ZP_BUFSND(EN,U,s1,s2,s3,d);</pre>

FBD/LD

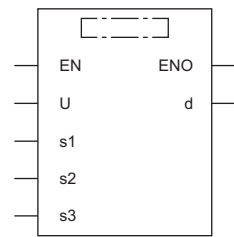

Execution condition

Instruction	Execution condition
GP.BUFSND ZP.BUFSND	

Setting data

Description, range, data type

Operand	Description	Range	Data type	Data type (label)
(U)	GP.BUFSND Start I/O number (first three digits in four-digit hexadecimal representation) of own station or own node	00H to FEH	16-bit unsigned binary	ANY16
	ZP.BUFSND Start I/O number (first three digits in four-digit hexadecimal representation) of own station or own node	00H to FEH	String	ANY16_OR_STRING_SINGLE
(s1)	Connection No.	1 to 16	16-bit unsigned binary	ANY16
(s2)	Start device of the own station where control data is stored	Refer to the control data.	Device name	ANY16 ^{*1}
(s3)	Own station start device where send data is stored	—	Device name	ANY16 ^{*1}
(d)	Device of the own station, which turns on for one scan upon completion of the instruction. When the instruction completes with an error, (d)+1 also turns on.	—	Bit	ANYBIT_ARRAY (Number of elements: 2)
EN	Execution condition	—	Bit	BOOL
ENO	Execution result	—	Bit	BOOL

*1 When specifying setting data by using a label, define an array to secure enough operation area and specify an element of the array label.

■Applicable devices

Operand	Bit		Word			Double word		Indirect specification	Constant			Others (U)
	X, Y, M, L, SM, F, B, SB, FX, FY	J□□	T, ST, C, D, W, SD, SW, FD, R, ZR, RD	U□\G□, J□□, U3E□\□(H)G□	Z	LT, LST, LC	LZ		K, H	E	\$	
(U)	GP.BUFSND	—	—	○	—	—	—	○	○	—	—	○
	ZP.BUFSND	—	—	○	—	—	—	○	—	—	○	○
(s1)		○*1	—	○*2	—	—	—	○	○	—	—	—
(s2)		—	—	○*2	—	—	—	○	—	—	—	—
(s3)		—	—	○*2	—	—	—	○	—	—	—	—
(d)		○*1	—	○*3	—	—	—	—	—	—	—	—

*1 FX and FY cannot be used.

*2 FD cannot be used.

*3 T, ST, C, and FD cannot be used.

■Control data

Operand: (s2)				
Device	Item	Description	Setting range	Set by
+0	System area	—	—	—
+1	Completion status	The completion status is stored upon completion of the instruction. • 0: Completed successfully • Other than 0: Completed with an error (error code)	—	System

■Send data

Operand: (s3)				
Device	Item	Description	Setting range	Set by
+0	Send data length	Specify the send data length. (Specify the data length in words or bytes according to the procedure of fixed buffer communications.)	With procedure (binary): Number of words 1 to 5113 (1 to 1017)*1 With procedure (ASCII): Number of words 1 to 2556 (1 to 508)*1 Without procedure (binary): Number of bytes 1 to 10238 (1 to 2046)*1	User
+1 to +□	Send data	Specify the send data.	—	User

*1 This setting range is applicable when the network type is "Q-compatible Ethernet".

Processing details

- This instruction sends the data in the device specified by (s3) to the external device of the connection specified by (s1) of the module specified by (U). These instructions can be used only for the connections for which "fixed buffer communication (with/without procedure)" is set as the communication means.

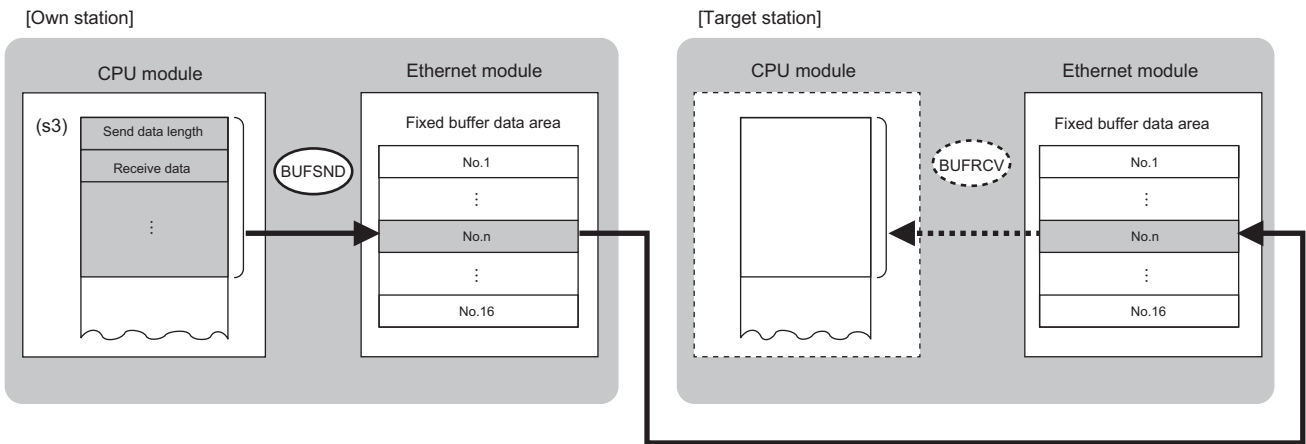

No.: Connection No.

- The execution status and the completion status of the BUFSND instruction can be checked with the completion device (d) and the completion status indication device (d)+1.

- Completion device (d)

This device turns on during END processing of the scan where the BUFSND instruction completes, and turns off during the next END processing.

- Completion status indication device (d)+1

This device turns on or off depending on the completion status of the BUFSND instruction.

When completed successfully: The device remains off.

When completed with an error: The device turns on during END processing of the scan where the BUFSND instruction completes, and turns off during the next END processing.

- The following figure shows the operation at completion of the BUFSND instruction.

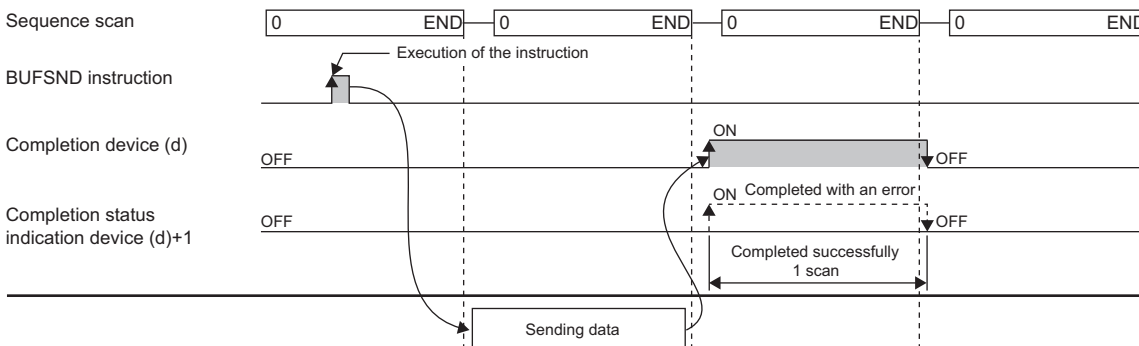

- The BUFSND instruction is executed on the rising edge (off to on) of the send command.

Operation error

Error code ((s2)+1)	Description
C000H to CBFH	MELSEC iQ-R Ethernet User's Manual (Application)
CFC0H to CFFFH	MELSEC iQ-R CPU Module User's Manual (Application)

4.4 Reinitializing the Module

G(P).UINI, Z(P).UINI

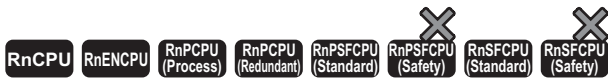

These instructions reinitialize the module. The UINI instruction can be used only when the network type is "Q-compatible Ethernet".

Ladder	ST
	<pre>ENO:=G_UINI(EN,U,s,d); ENO:=GP_UINI(EN,U,s,d); ENO:=Z_UINI(EN,U,s,d); ENO:=ZP_UINI(EN,U,s,d);</pre>

FBD/LD

Execution condition

Instruction	Execution condition
G.UINI Z.UINI	
GP.UINI ZP.UINI	

Setting data

Description, range, data type

Operand	Description	Range	Data type	Data type (label)
(U)	G(P).UINI Start I/O number (first three digits in four-digit hexadecimal representation) of own station or own node	00H to FEH	16-bit unsigned binary	ANY16
	Z(P).UINI Start I/O number (first three digits in four-digit hexadecimal representation) of own station or own node	00H to FEH	String	ANY16_OR_STRING_SINGLE
(s)	Start device of the own station where control data is stored	Refer to the control data.	Device name	ANY16 ^{*1}
(d)	Device of the own station, which turns on for one scan upon completion of the instruction. When the instruction completes with an error, (d)+1 also turns on.	—	Bit	ANYBIT_ARRAY (Number of elements: 2)
EN	Execution condition	—	Bit	BOOL
ENO	Execution result	—	Bit	BOOL

*1 When specifying setting data by using a label, define an array to secure enough operation area and specify an element of the array label.

■Applicable devices

Operand	Bit			Word			Double word		Indirect specification	Constant			Others (U)
	X, Y, M, L, SM, F, B, SB, FX, FY	J□□	□□	T, ST, C, D, W, SD, SW, FD, R, ZR, RD	U□\G□, J□□□, U3E□(H)G□	Z	LT, LST, LC	LZ		K, H	E	\$	
(U)	G(P).UINI	—	—	○	—	—	—	—	○	○	—	—	○
	Z(P).UINI	—	—	○	—	—	—	—	○	—	—	○	○
(s)		—	—	○*2	—	—	—	—	○	—	—	—	—
(d)		○*1	—	○*3	—	—	—	—	—	—	—	—	—

*1 FX and FY cannot be used.

*2 FD cannot be used.

*3 T, ST, C, and FD cannot be used.

■Control data

Operand: (s)																												
Device	Item	Description	Setting range	Set by																								
+0	System area	—	—	—																								
+1	Completion status	The completion status is stored upon completion of the instruction. <ul style="list-style-type: none"> • 0: Completed successfully • Other than 0: Completed with an error (error code) 	—	System																								
+2	Change target specification	<p>■To change the address information of the external device held by the Ethernet module Specify 0000H.*1</p> <p>■To change the own station IP address, operation setting, transmission speed, or communication mode Specify the parameter of the change target. Note that changing the transmission speed and communication mode cannot be specified together with the change specification of the own station IP address or operation setting. If they are specified together, the change specification of only the own station IP address or operation setting is executed.</p> <table border="1" style="margin-left: 20px;"> <tr> <td style="text-align: center;">b15</td> <td style="text-align: center;">...</td> <td style="text-align: center;">b12</td> <td style="text-align: center;">b11</td> <td style="text-align: center;">...</td> <td style="text-align: center;">b2</td> <td style="text-align: center;">b1</td> <td style="text-align: center;">b0</td> </tr> <tr> <td style="text-align: center;">(3)</td> <td></td> <td style="text-align: center;">0</td> <td></td> <td></td> <td style="text-align: center;">(2)</td> <td style="text-align: center;">(1)</td> <td></td> </tr> </table> <p>(1) Own station IP address change specification (b0) Specify whether to change the IP address of the own station. (When changing the IP address, specify a new address in (s)+3, (s)+4.) <ul style="list-style-type: none"> • 0: Not changed • 1: Changed </p> <p>(2) Operation setting change specification (b1) Specify whether to change the Ethernet operation setting. (When changing the setting, specify a new setting in (s)+5.) <ul style="list-style-type: none"> • 0: Not changed • 1: Changed </p> <p>(3) Transmission speed and communication mode change specification (b12 to b15) Specify the transmission speed and communication mode. <ul style="list-style-type: none"> • 0: Not changed • 1: Auto negotiation*2 • 2: 100Mbps/full duplex • 3: 100Mbps/half-duplex • 4: 10Mbps/full duplex • 5: 10Mbps/half-duplex </p>	b15	...	b12	b11	...	b2	b1	b0	(3)		0			(2)	(1)		0000H to 5000H	User								
b15	...	b12	b11	...	b2	b1	b0																					
(3)		0			(2)	(1)																						
+3 +4	Own station IP address	Specify the IP address of the own station. <ul style="list-style-type: none"> • (s)+3 <table border="1" style="margin-left: 20px;"> <tr> <td style="text-align: center;">b15</td> <td style="text-align: center;">...</td> <td style="text-align: center;">b8</td> <td style="text-align: center;">b7</td> <td style="text-align: center;">...</td> <td style="text-align: center;">b0</td> </tr> <tr> <td colspan="6" style="text-align: center;">[]</td> </tr> </table> <ul style="list-style-type: none"> • b8 to b15: 3rd octet • b0 to b7: 4th octet <ul style="list-style-type: none"> • (s)+4 <table border="1" style="margin-left: 20px;"> <tr> <td style="text-align: center;">b15</td> <td style="text-align: center;">...</td> <td style="text-align: center;">b8</td> <td style="text-align: center;">b7</td> <td style="text-align: center;">...</td> <td style="text-align: center;">b0</td> </tr> <tr> <td colspan="6" style="text-align: center;">[]</td> </tr> </table> <ul style="list-style-type: none"> • b8 to b15: 1st octet • b0 to b7: 2nd octet 	b15	...	b8	b7	...	b0	[]						b15	...	b8	b7	...	b0	[]						0000001H to FFFFFFFEH	User
b15	...	b8	b7	...	b0																							
[]																												
b15	...	b8	b7	...	b0																							
[]																												

Operand: (s)											
Device	Item	Description	Setting range	Set by							
+5	Ethernet operation setting	Specify the operation setting. b15 ... b9 b8 b7 b6 b5 ... b2 b1 b0 <table border="1" style="margin-left: 20px;"> <tr> <td style="width: 20px;">0</td> <td style="width: 20px;">(3)</td> <td style="width: 20px;">0</td> <td style="width: 20px;">(2)</td> <td style="width: 20px;">0</td> <td style="width: 20px;">(1)</td> <td style="width: 20px;">0</td> </tr> </table> (1) Communication data code setting (b1) • 0: Binary • 1: ASCII (2) Online change enable/disable setting (b6) • 0: Disable all at once (SLMP) • 1: Enable all at once (SLMP) (3) Opening method setting (b8) • 0: Open with the program. • 1: Do not open with the program.	0	(3)	0	(2)	0	(1)	0	Left	User
0	(3)	0	(2)	0	(1)	0					

*1 The instruction clears and reinitializes the address information of the external device held by the Ethernet module so that data communication can be restarted. (The initialization normal completion signal (X19) turns on.)

*2 When auto negotiation is specified, use 1000BASE-T.

Processing details

- These instructions reinitializes the Ethernet module specified by (U). If changing the IP address is specified, change the IP address of the Ethernet module of the own station.

- The execution status and the completion status of the UINI instruction can be checked with the completion device (d) and the completion status indication device (d)+1.

- Completion device (d)

This device turns on during END processing of the scan where the UINI instruction completes, and turns off during the next END processing.

- Completion status indication device (d)+1

This device turns on or off depending on the completion status of the UINI instruction.

When completed successfully: The device remains off.

When completed with an error: The device turns on during END processing of the scan where the UINI instruction completes, and turns off during the next END processing.

- The following figure shows the operation at completion of the UINI instruction.

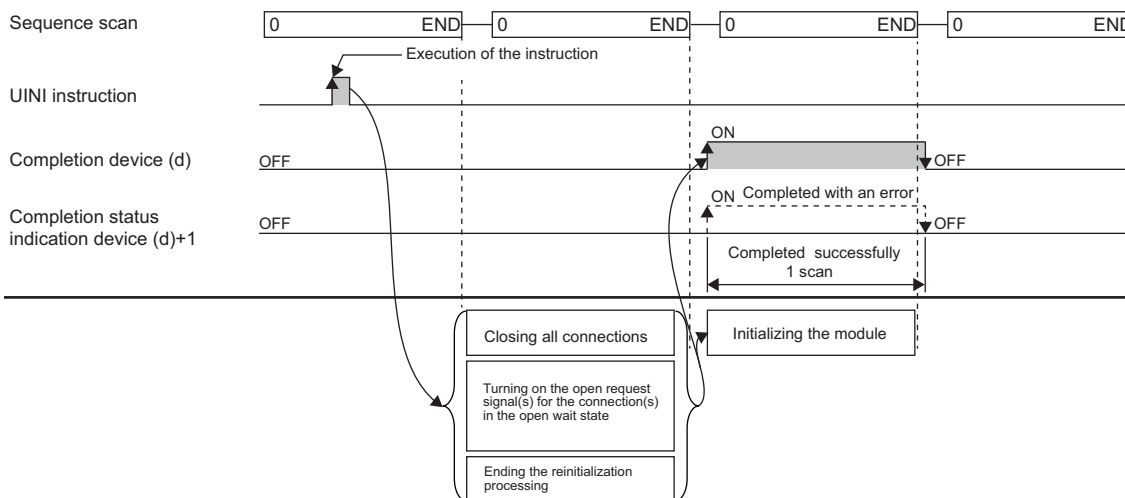

- The UINI instruction is executed on the rising edge (off to on) of the reinitialize command.



Precautions

- When executed, the instruction forcibly closes all connections and initialize the internal information of the module.

- If the IP address is changed, communication is stopped. When an engineering tool is connected via Ethernet, the IP address of the Ethernet-equipped module should be corrected to the new IP address in the "Specify Connection Destination Connection" window before restarting communications.

- If the IP address is changed while "Use IP address" is selected in "Network No. and station number setting method" of the engineering tool, the network number and station number are not changed and the value using the IP address that is set by a parameter remains unchanged.

Operation error

Error code ((s)+1)	Description
C000H to CFBFH	 MELSEC iQ-R Ethernet User's Manual (Application)
CFC0H to CFFFH	 MELSEC iQ-R CPU Module User's Manual (Application)

4.5 Executing the Protocols Registered for the Predefined Protocol Support Function

GP.ECPRTCL

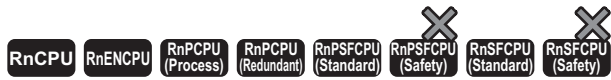

This instruction executes the communication protocol registered using the engineering tool.

Ladder	ST
	<pre>ENO:=GP_ECPRTCL(EN,U,s1,s2,s3,d);</pre>

FBD/LD

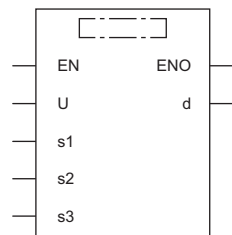

■ Execution condition

Instruction	Execution condition
GP.ECPRTCL	

Setting data

■ Description, range, data type

Operand	Description	Range	Data type	Data type (label)
(U)	Start I/O number (first three digits in four-digit hexadecimal representation) of own station or own node	00H to FEH	16-bit unsigned binary	ANY16
(s1)	Connection No.	1 to 16	16-bit unsigned binary	ANY16
(s2)	Number of protocols to be executed continuously	1 to 8	16-bit unsigned binary	ANY16
(s3)	Start device of the own station where control data is stored	Refer to the control data.	Device name	ANY16 ^{*1}
(d)	Device of the own station, which turns on for one scan upon completion of the instruction. When the instruction completes with an error, (d)+1 also turns on.	—	Bit	ANYBIT_ARRAY (Number of elements: 2)
EN	Execution condition	—	Bit	BOOL
ENO	Execution result	—	Bit	BOOL

*1 When specifying setting data by using a label, define an array to secure enough operation area and specify an element of the array label.

■Applicable devices

Operand	Bit		Word			Double word		Indirect specification	Constant			Others (U)
	X, Y, M, L, SM, F, B, SB, FX, FY	J□□	T, ST, C, D, W, SD, SW, FD, R, ZR, RD	U□V□, J□□, U3E□(H)G□	Z	LT, LST, LC	LZ		K, H	E	\$	
(U)	—	—	○	—	—	—	○	○	—	—	○	
(s1)	○*1	—	○*2	—	—	—	○	○	—	—	—	
(s2)	○*1	—	○*2	—	—	—	○	○	—	—	—	
(s3)	—	—	○*2	—	—	—	○	—	—	—	—	
(d)	○*1	—	○*3	—	—	—	—	—	—	—	—	

*1 FX and FY cannot be used.

*2 FD cannot be used.

*3 T, ST, C, and FD cannot be used.

■Control data

Operand: (s3)				
Device	Item	Description	Setting range	Set by
+0	Resulting number of executed protocols	The number of protocols executed by the GPECPRTCL instruction is stored. Any protocol where an error occurred is also included in the execution number. If the setting of setting data or control data contains an error, "0" is stored.	0, 1 to 8	System
+1	Completion status	The completion status is stored upon completion of the instruction. If two or more protocols are executed, the execution result of the last protocol will be stored. • 0: Completed successfully • Other than 0: Completed with an error (error code)	—	System
+2	Execution protocol number 1	Specify the number of the protocol to be executed first.	1 to 128	User
+3	Execution protocol number 2	Specify the number of the protocol to be executed second.	0, 1 to 128	User
+4	Execution protocol number 3	Specify the number of the protocol to be executed third.	0, 1 to 128	User
+5	Execution protocol number 4	Specify the number of the protocol to be executed fourth.	0, 1 to 128	User
+6	Execution protocol number 5	Specify the number of the protocol to be executed fifth.	0, 1 to 128	User
+7	Execution protocol number 6	Specify the number of the protocol to be executed sixth.	0, 1 to 128	User
+8	Execution protocol number 7	Specify the number of the protocol to be executed seventh.	0, 1 to 128	User
+9	Execution protocol number 8	Specify the number of the protocol to be executed eighth.	0, 1 to 128	User
+10	Receive packet number 1 successful in collation match	If receiving is included in the communication type of the protocol that has been executed first, the receive packet number successful in collation match is stored. If the communication type is "receive only", 0 is stored. If an error occurs during execution of the first protocol, 0 is stored.	0, 1 to 16	System
+11	Receive packet number 2 successful in collation match	If receiving is included in the communication type of the protocol that has been executed second, the receive packet number successful in collation match is stored. If the communication type is "receive only", 0 is stored. If an error occurs during execution of the second protocol, "0" is stored. If the number of protocols executed is less than 2, 0 is stored.	0, 1 to 16	System
+12	Receive packet number 3 successful in collation match	If receiving is included in the communication type of the protocol that has been executed third, the receive packet number successful in collation match is stored. If the communication type is "receive only", 0 is stored. If an error occurs during execution of the third protocol, 0 is stored. If the number of protocols executed is less than 3, 0 is stored.	0, 1 to 16	System

Operand: (s3)				
Device	Item	Description	Setting range	Set by
+13	Receive packet number 4 successful in collation match	If receiving is included in the communication type of the protocol that has been executed fourth, the receive packet number successful in collation match is stored. If the communication type is "receive only", 0 is stored. If an error occurs during execution of the fourth protocol, 0 is stored. If the number of protocols executed is less than 4, 0 is stored.	0, 1 to 16	System
+14	Receive packet number 5 successful in collation match	If receiving is included in the communication type of the protocol that has been executed fifth, the receive packet number successful in collation match is stored. If the communication type is "receive only", 0 is stored. If an error occurs during execution of the fifth protocol, 0 is stored. If the number of protocols executed is less than 5, 0 is stored.	0, 1 to 16	System
+15	Receive packet number 6 successful in collation match	If receiving is included in the communication type of the protocol that has been executed sixth, the receive packet number successful in collation match is stored. If the communication type is "receive only", 0 is stored. If an error occurs during execution of the sixth protocol, 0 is stored. If the number of protocols executed is less than 6, 0 is stored.	0, 1 to 16	System
+16	Receive packet number 7 successful in collation match	If receiving is included in the communication type of the protocol that has been executed seventh, the receive packet number successful in collation match is stored. If the communication type is "receive only", 0 is stored. If an error occurs during execution of the seventh protocol, 0 is stored. If the number of protocols executed is less than 7, 0 is stored.	0, 1 to 16	System
+17	Receive packet number 8 successful in collation match	If receiving is included in the communication type of the protocol that has been executed eighth, the receive packet number successful in collation match is stored. If the communication type is "receive only", 0 is stored. If an error occurs during execution of the eighth protocol, 0 is stored. If the number of protocols executed is less than 8, 0 is stored.	0, 1 to 16	System

Processing details

- This instruction executes the protocol registered by the communication protocol support tool of the engineering tool for the Ethernet module specified by (U). Using the connection specified by (s1), the instruction executes the protocol in accordance with the control data stored in the device specified by (s3) and later.
- The instruction continuously executes as many protocols as specified by (s2) (a maximum of 8 protocols) at one time.
- The number of executed protocols is stored in the device specified by (s3)+0.
- The execution status and the completion status of the GP.ECPRTCL instruction can be checked with the completion device (d) and the completion status indication device (d)+1.

• Completion device (d)

This device turns on during END processing of the scan where the GP.ECPRTCL instruction completes, and turns off during the next END processing.

• Completion status indication device (d)+1

This device turns on or off depending on the completion status of the GP.ECPRTCL instruction.

When completed successfully: The device remains off.

When completed with an error: The device turns on during END processing of the scan where the GP.ECPRTCL instruction completes, and turns off during the next END processing.

- The following figure shows the operation at completion of the GP.ECPRTCL instruction.

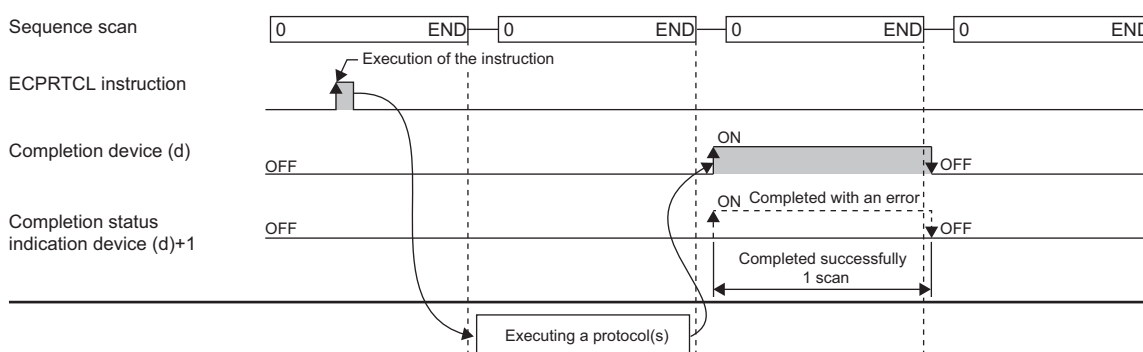

■Canceling protocol execution

A protocol can be canceled during its execution. The canceled protocol stops the processing and completes with an error. If multiple protocols are being executed sequentially, the current protocol is forcibly terminated, and the subsequent protocols are not executed.

Note that if the Ethernet-equipped module has started sending data, the send processing cannot be canceled even the protocol execution is canceled. The following table summarizes the cancellation timings and operation results.

Protocol operation	Cancellation timing (protocol execution status)	Operation result	
		Completion status	Handling of data
Sending data	'Protocol execution start' to 'Before transmission start (waiting for transmission)'	Completed with an error (protocol cancellation request error)	Data not being sent
	'Transmission start' to 'Before protocol execution completion'		Data being sent
Receiving data	Any time		Data not being received

To request a protocol cancellation, use the module label, "Protocol cancellation specification". Set 1 (Cancellation request) to the module label, "Protocol cancellation specification", of the cancellation-target connection. The label states transition as follows:

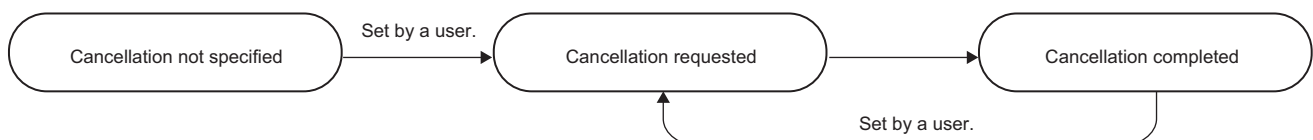

Protocol cancellation specification	Description
No cancellation specified	A state that a cancellation has never been requested since the system was powered on or the CPU module was reset. Once a protocol cancellation is requested, the label never returns to this state.
Cancellation requested	A state that a protocol cancellation has been requested by a user. The label is in this state until the processing completes.
Cancellation completed	A state that the cancellation processing has been completed



Point

- If a cancellation is requested while no protocol is being executed, the module performs no processing.
- The module periodically checks for a cancellation request. It may take time until the protocol is actually canceled after the cancellation was requested.
- While the protocol cancellation specification state is "Cancellation requested", another GP.ECPRTCL instruction cannot be executed.

Precautions

- If an error occurs in the m th protocol while multiple protocols are being executed, the instruction does not execute the " $m+1$ "th protocol and after and is completed with an error.
- The connections for which the GP.ECPRTCL instruction can be executed are only those for which "Communication protocol" is specified for the communication means.
- If a cancel request is received during execution of the m th protocol while multiple protocols are executed continuously, the Ethernet module stores the protocol number m being executed in the device specified by $(s3)+0$, the receive packet number successful in collation match for the already executed protocol in the device specified by 1 to $(m-1)$, and the protocol cancel request error (error code: C404H) in the device specified by $(s3)+1$.
- When a protocol including no-conversion variables is executed, the total data length of the variables used in one packet may exceed 1920 bytes. In this case, the instruction may obtain CPU device values over several scans. Therefore, do not change the CPU device values specified in non-conversion variables from the start of the dedicated instruction to the end of execution.
- The intelligent function module device (buffer memory) is not affected by the sequence scan of the CPU module and therefore can process protocols faster than assigning programmable controller devices to variables.
- If protocol setting data is written during execution of the GP.ECPRTCL instruction, the protocol in execution is canceled upon completion of writing and the instruction is completed with a protocol setting data write error (error code: C430H).
- If the fixed buffer send/receive mode (such as send) of the specified connection has an invalid combination with the communication type of the protocol to be executed (such as receive only) while the connection number of the Ethernet module is one from 1 to 16, the GP.ECPRTCL instruction is completed with a connection number setting error (error code: C407H).
- If the receive waiting time is set to "0: Infinite wait", the GP.ECPRTCL instruction is not completed until the data specified in the protocol setting is received.

Operation error

Error code $((s3)+1)$	Description
C000H to CFBFH	 MELSEC iQ-R Ethernet User's Manual (Application)
CFC0H to CFFFH	 MELSEC iQ-R CPU Module User's Manual (Application)

4.6 Clearing Error Information

GP.ERRRCLEAR, ZP.ERRRCLEAR

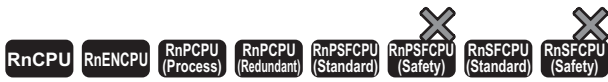

These instructions turn off the LEDs and clear error information.*1

Ladder	ST
	<pre>ENO:=GP_ERRRCLEAR(EN,U,s,d); ENO:=ZP_ERRRCLEAR(EN,U,s,d);</pre>

FBD/LD

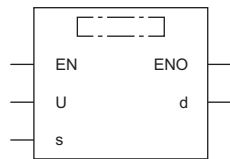

*1 To turn off the LEDs, use the RJ71EN71 with a firmware version of "05" or later.

Execution condition

Instruction	Execution condition
GP.ERRRCLEAR ZP.ERRRCLEAR	

Setting data

Description, range, data type

Operand	Description	Range	Data type	Data type (label)
(U)	GP.ERRRCLEAR Start I/O number (first three digits in four-digit hexadecimal representation) of own station or own node	00H to FEH	16-bit unsigned binary	ANY16
	ZP.ERRRCLEAR Start I/O number (first three digits in four-digit hexadecimal representation) of own station or own node	00H to FEH	String	ANY16_OR_STRING_SINGLE
(s)	Start device of the own station where control data is stored	Refer to the control data.	Device name	ANY16*1
(d)	Device of the own station, which turns on for one scan upon completion of the instruction. When the instruction completes with an error, (d)+1 also turns on.	—	Bit	ANYBIT_ARRAY (Number of elements: 2)
EN	Execution condition	—	Bit	BOOL
ENO	Execution result	—	Bit	BOOL

*1 When specifying setting data by using a label, define an array to secure enough operation area and specify an element of the array label.

■Applicable devices

Operand	Bit		Word			Double word		Indirect specification	Constant			Others (U)
	X, Y, M, L, SM, F, B, SB, FX, FY	J□□	T, ST, C, D, W, SD, SW, FD, R, ZR, RD	U□\G□, J□□, U3E□\□(H)G□	Z	LT, LST, LC	LZ		K, H	E	\$	
(U)	GP.ERRCLEAR	—	—	○	—	—	—	○	○	—	—	○
	ZP.ERRCLEAR	—	—	○	—	—	—	○	—	—	○	○
(s)		—	—	○*2	—	—	—	○	—	—	—	—
(d)		○*1	—	○*3	—	—	—	—	—	—	—	—

*1 FX and FY cannot be used.

*2 FD cannot be used.

*3 T, ST, C, and FD cannot be used.

■Control data

Operand: (s)				
Device	Item	Description	Setting range	Set by
+0	System area	—	—	—
+1	Completion status	The completion status is stored upon completion of the instruction. <ul style="list-style-type: none"> • 0: Completed successfully • Other than 0: Completed with an error (error code) 	—	System
+2	Clear target specification	Specify the error information to clear.	0000H to 0080H, 0100H, 0101H, 8101H, FFFFH	User
+3	Clear function specification	Specify the function to clear. <ul style="list-style-type: none"> • 0000H: Clear the error code. • FFFFH: Clear the error log. 	0000H, FFFFH	User
+4	LED off specification	Specify the off-target LED (ERR LED, P ERR LED of PORT1, or P ERR LED of PORT2). <ul style="list-style-type: none"> • 0000H: Do not turn off any ERR LED. • 0001H: Turn off the P ERR LED of PORT1. • 8001H: Turn off the P ERR LED of PORT2. • FFFFH: Turn off all ERR LEDs. If 0001H or 8001H is specified and the P ERR LEDs of PORT1 and PORT2 are both off after the ERRCLEAR instruction is executed, the ERR LED automatically turns off. If either one of the P ERR LED is on, the ERR LED also remains on.	0000H, 0001H, 8001H, FFFFH	User
+5 to +7	System area	—	—	—

Processing details

- These instructions clear following error information with regard to the module specified by (U).



Target name		Clear target specification (s)+2	Clear function specification (s)+3	Specify the error information to clear.	Buffer memory address	
					Network type: Ethernet	Network type: Q-compatible Ethernet
Initial error		0000H	0000H	Initial error code	1900025	105
Open error		0001H to 0080H ^{*1}	0000H	Open error code of connection The open error code of connection No. 1 to 128 (0001H to 0080H) is cleared.	100 to 163, 2000100 to 2000163	124, 134, 144, 154, 164, 174, 184, 194, 22564, 22574, 22584, 22594, 22604, 22614, 22624, 22634
Error log ^{*2}		0100H	FFFFH	Error log	—	227 to 372
Communication status (PORT1)	Status by protocol	0101H	FFFFH	PORT1 communication status by protocol	5000 to 5188	376 to 511
Communication status (PORT2) ^{*3}	Status by protocol	8101H	FFFFH	PORT2 communication status by protocol	2005000 to 2005188	—
All error information		FFFFH	FFFFH	All the information above is cleared.	—	—

*1 Only 0001H to 0010H can be specified when the network type is Q-compatible Ethernet.

*2 The error log can be cleared only when the network type is Q-compatible Ethernet.

*3 The initial error can be cleared only when the network type is Ethernet.

Operation error

Error code ((s)+1)	Description
C000H to CFBFH	 MELSEC iQ-R Ethernet User's Manual (Application)
CFC0H to CFFFH	 MELSEC iQ-R CPU Module User's Manual (Application)

4.7 Reading Error Information

GP.ERRRD, ZP.ERRRD

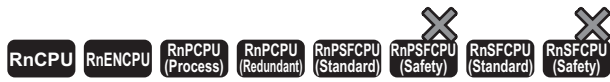

These instructions read error information.

Ladder	ST
	<pre>ENO:=GP_ERRRD(EN,U,s,d); ENO:=ZP_ERRRD(EN,U,s,d);</pre>

FBD/LD

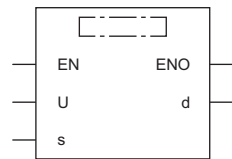

Execution condition

Instruction	Execution condition
GP.ERRRD ZP.ERRRD	

Setting data

Description, range, data type

Operand	Description	Range	Data type	Data type (label)
(U)	GP.ERRRD Start I/O number (first three digits in four-digit hexadecimal representation) of own station or own node	00H to FEH	16-bit unsigned binary	ANY16
	ZP.ERRRD Start I/O number (first three digits in four-digit hexadecimal representation) of own station or own node	00H to FEH	String	ANY16_OR_STRING_SINGLE
(s)	Start device of the own station where control data is stored	Refer to the control data.	Device name	ANY16 ^{*1}
(d)	Device of the own station, which turns on for one scan upon completion of the instruction. When the instruction completes with an error, (d)+1 also turns on.	—	Bit	ANYBIT_ARRAY (Number of elements: 2)
EN	Execution condition	—	Bit	BOOL
ENO	Execution result	—	Bit	BOOL

*1 When specifying setting data by using a label, define an array to secure enough operation area and specify an element of the array label.

■Applicable devices

Operand	Bit		Word			Double word		Indirect specification	Constant			Others (U)
	X, Y, M, L, SM, F, B, SB, FX, FY	J□□	T, ST, C, D, W, SD, SW, FD, R, ZR, RD	U□\G□, J□\□, U3E□\□(H)G□	Z	LT, LST, LC	LZ		K, H	E	\$	
(U)	GP.ERRRD	—	—	○	—	—	—	○	○	—	—	○
	ZP.ERRRD	—	—	○	—	—	—	○	—	—	○	○
(s)		—	—	○*2	—	—	—	○	—	—	—	—
(d)		○*1	—	○*3	—	—	—	—	—	—	—	—

*1 FX and FY cannot be used.

*2 FD cannot be used.

*3 T, ST, C, and FD cannot be used.

■Control data

Operand: (s)				
Device	Item	Description	Setting range	Set by
+0	System area	—	—	—
+1	Completion status	The completion status is stored upon completion of the instruction. • 0: Completed successfully • Other than 0: Completed with an error (error code)	—	System
+2	Read information specification	Specify the error information to read.	0000H to 0080H	User
+3	Read target information specification	Specify the target of the error information to read. • 0000H: Latest error information	0000H	User
+4	Error information	The error information that has been read is stored. • 0000H: No error • Other than 0000H: Error code	—	System
+5 to +7	System area	—	—	—

Processing details

- These instructions read the following error information with regard to the module specified by (U).

Target name	Read information specification (s)+2	Read target information specification (s)+3	Error information to read	Buffer memory address	
				Network type: Ethernet	Network type: Q-compatible Ethernet
Initial error	0000H	0000H	Initial error code	1900025	105
Open error	0001H to 0080H*1	0000H	Open error code of connection The open error code of connection No. 1 to 128 (0001H to 0080H) is read.	100 to 163, 2000100 to 2000163	124, 134, 144, 154, 164, 174, 184, 194, 22564, 22574, 22584, 22594, 22604, 22614, 22624, 22634

*1 Only 0001H to 0010H can be specified when the network type is Q-compatible Ethernet.

Operation error

Error code ((s)+1)	Description
C000H to CFBFH	MELSEC iQ-R Ethernet User's Manual (Application)
CFC0H to CFFFH	MELSEC iQ-R CPU Module User's Manual (Application)

5 CC-Link IE TSN INSTRUCTIONS

5.1 Reading Data from the Remote Station (16-bit Address Specified)

JP.REMFR, ZP.REMFR

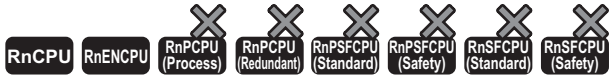

These instructions read data from the buffer memory of the remote station. (in units of words, 16-bit address specified).

Ladder	ST
	ENO:=JP_REMFR(EN,J,s1,s2,s3,s4,n,d1,d2); ENO:=ZP_REMFR(EN,J,s1,s2,s3,s4,n,d1,d2);

FBD/LD

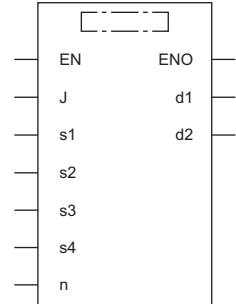

Execution condition

Instruction	Execution condition
JP.REMFR ZP.REMFR	

Setting data

■Description, range, data type

Operand		Description	Range	Data type	Data type (label)
(J)	JP.REMFR	Target network number	1 to 239	16-bit unsigned binary	ANY16
	ZP.REMFR	Target network number	1 to 239	String	ANY16_OR_STRING_SINGLE
(s1)		Channel of the own station, which is used for the instruction ^{*1}	1 to 32	16-bit unsigned binary	ANY16
(s2)		Target station number	1 to 120	16-bit unsigned binary	ANY16
(s3)		Start I/O number of target station	00H (fixed)	16-bit unsigned binary	ANY16
(s4)		Start address of the buffer memory area of the remote device station where the read-target data is stored	0000H to FFFFH (0 to 65535)	16-bit unsigned binary	ANY16
(d1)		Start device of the own station for storing the read data	—	Device name	ANY16 ^{*2}
(n)		Number of read data points (in units of words)	1 to 240	16-bit unsigned binary	ANY16
(d2)		Device of the own station, which turns on for one scan upon completion of the instruction. When the instruction completes with an error, (d2)+1 also turns on.	—	Bit	ANYBIT_ARRAY (Number of elements: 2)
EN		Execution condition	—	Bit	BOOL
ENO		Execution result	—	Bit	BOOL

*1 The channel is used for the REMFR, REMTO, REMFRD, REMTOD, REMFRIP, REMTOIP, REMFRDIP, and REMTODIP instructions. The same channel number used for the link dedicated instructions (such as the READ instruction) can be set.

*2 When specifying data with a label, define the array so that an area required for operation can be secured, and specify the array label element.

Point

Use the REMFRD or REMFRDIP instruction if the start address of the buffer memory area (s4) exceeds FFFFH (65535).

■Applicable devices

Operand	Bit			Word			Double word		Indirect specification	Constant			Others (J)
	X, Y, M, L, SM, F, B, SB, FX, FY	J□□		T, ST, C, D, W, SD, SW, FD, R, ZR, RD	U□□□, J□□, U3E□(H)□□	Z	LT, LST, LC	LZ		K, H	E	\$	
(J)	JP.REMFR	—	—	—	—	—	—	—	—	—	—	—	○
	ZP.REMFR	—	—	—	—	—	—	—	—	—	—	○	○
(s1)	○ ^{*1}	—	—	○ ^{*2}	—	—	—	○	○	—	—	—	—
(s2)	○ ^{*1}	—	—	○ ^{*2}	—	—	—	○	○	—	—	—	—
(s3)	○ ^{*1}	—	—	○ ^{*2}	—	—	—	○	○	—	—	—	—
(s4)	○ ^{*1}	—	—	○ ^{*2}	—	—	—	○	○	—	—	—	—
(d1)	—	—	—	○ ^{*2}	—	—	—	○	—	—	—	—	—
(n)	○ ^{*1}	—	—	○ ^{*2}	—	—	—	○	○	—	—	—	—
(d2)	○ ^{*1}	—	—	○ ^{*3}	—	—	—	—	—	—	—	—	—

*1 FX and FY cannot be used.

*2 FD cannot be used.

*3 T, ST, C, and FD cannot be used.

Processing details

- This instruction reads the data from the start address (s4) of the buffer memory area of the remote station to the word device ((d1) and later) of the own station for the specified number of words (n). Specify the target station by using (J), (s2), and (s3). The completion device (d2) turns on upon completion of the instruction.

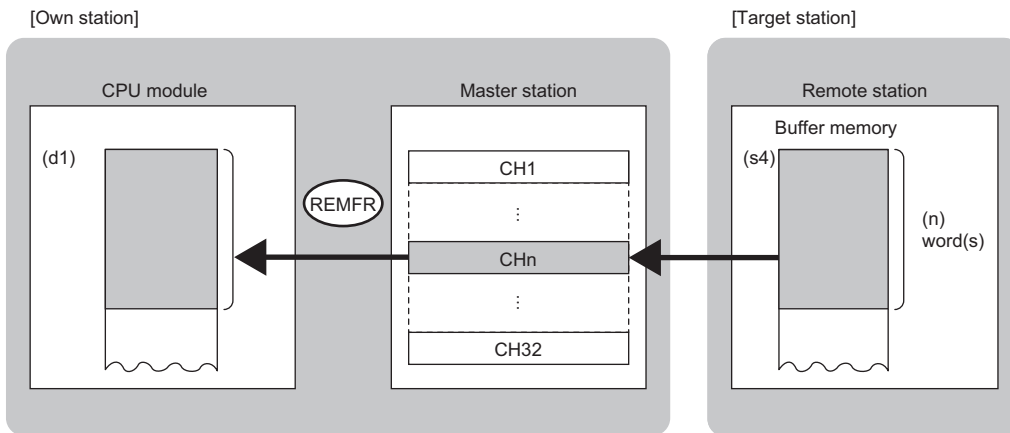

CH: Channel

- The execution status and the completion status of the REMFR instruction can be checked with the completion device (d2) and the completion status indication device (d2)+1.

- Completion device (d2)

This device turns on during END processing of the scan where the REMFR instruction completes, and turns off during the next END processing.

- Completion status indication device (d2)+1

This device turns on or off depending on the completion status of the REMFR instruction.

When completed successfully: The device remains off.

When completed with an error: The device turns on during END processing of the scan where the REMFR instruction completes, and turns off during the next END processing.

- The following figures show how the REMFR instruction operates when its execution has completed.
- When completed successfully

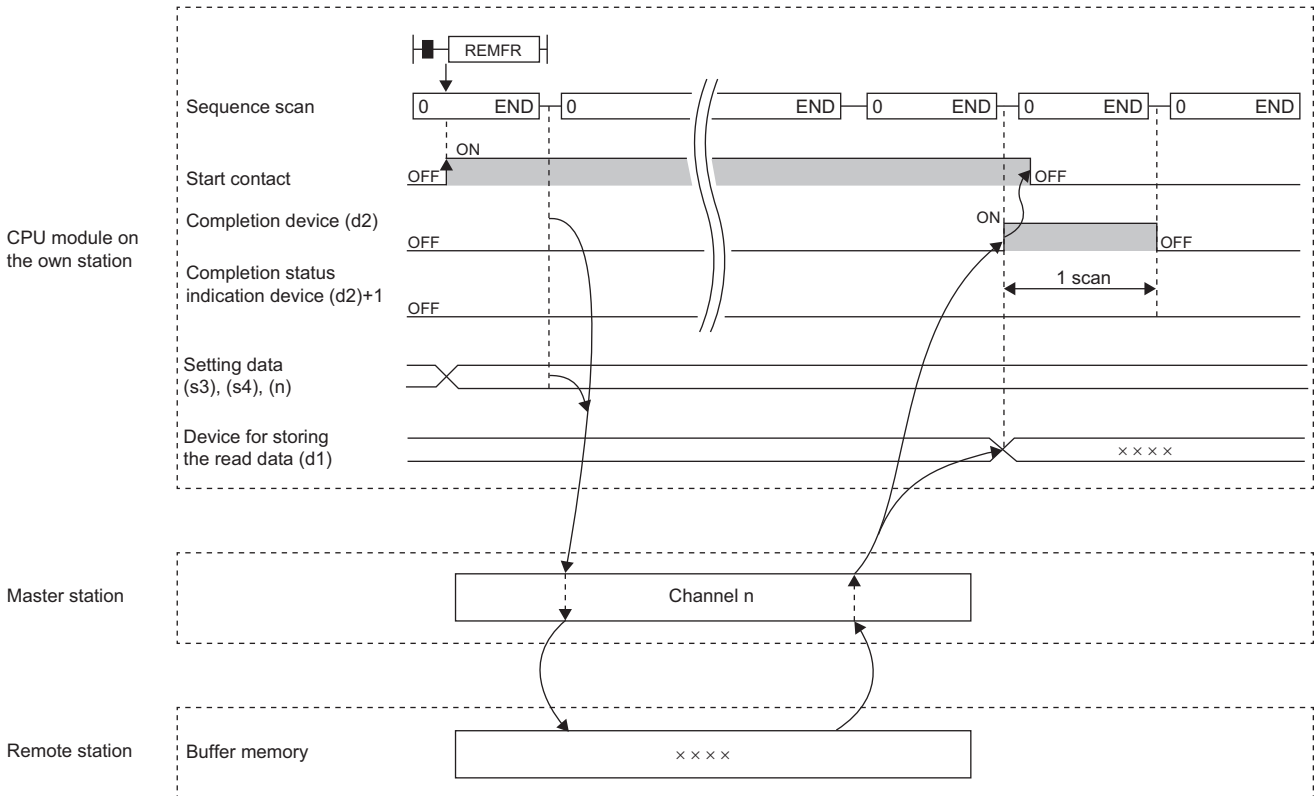

- When completed with an error

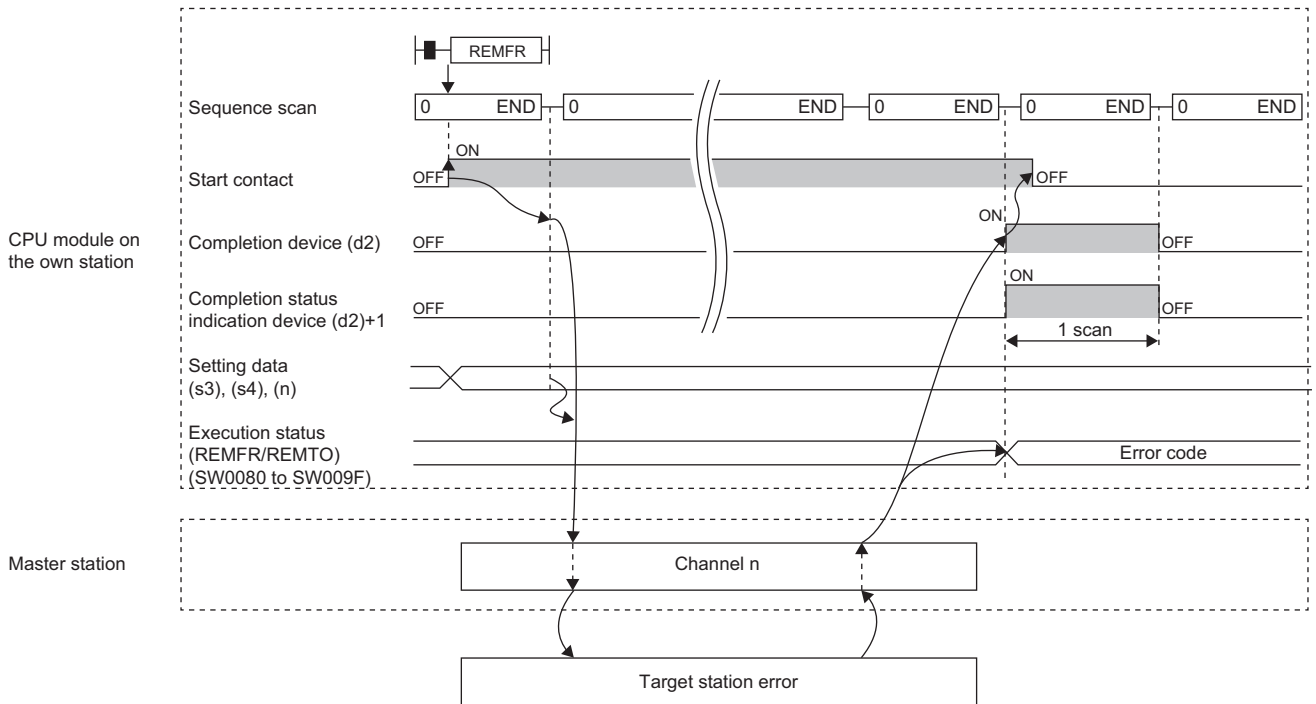

For the REMFR instruction, the number of resends and the response wait timer can be set in the following link special register (SW) areas.

- Number of resends (REMFR/REMTO) (SW001A)
- Response wait timer (REMFR/REMTO) (SW001B)

If the number of resends (REMFR/REMTO) (SW001A) is set, the REMFR instruction completes with an error after the following time has elapsed:

$(\text{Number of resends (REMFR/REMTO)} + 1) \times \text{Response wait timer (REMFR/REMTO)}$



Note, however, that no retry is performed if the target station is disconnected at the REMFR instruction execution. If the REMFR instruction completes with an error, execute the instruction again after the target station returns to the system.

Precautions

For the REMFR instruction, check the following before using the instruction.

- The REMFR instruction can be used in the target station.
- The area can be accessed in the target station.

Operation error

Error code (SW0080 to SW009F)	Description
4000H to 4FFFH	 Refer to the manual of the target station connected.
C000H to CFFFH D000H to DFFFH E000H to EFFFH	 MELSEC iQ-R CC-Link IE TSN User's Manual (Application)

5.2 Writing Data to the Remote Station (16-bit Address Specified)

JP.REMTO, ZP.REMTO

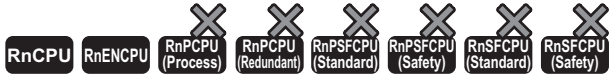

These instructions write data to the buffer memory area of the remote station. (in units of words, 16-bit address specified).

Ladder	ST
	ENO:=JP_REMTO(EN,J,s1,s2,s3,s4,s5,n,d); ENO:=ZP_REMTO(EN,J,s1,s2,s3,s4,s5,n,d);

FBD/LD

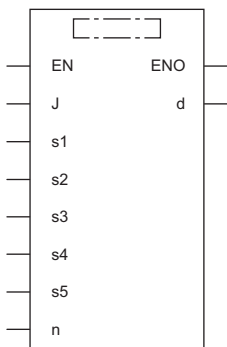

■ Execution condition

Instruction	Execution condition
JP.REMTO ZP.REMTO	

Setting data

■Description, range, data type

Operand		Description	Range	Data type	Data type (label)
(J)	JP.REMTO	Target network number	1 to 239	16-bit unsigned binary	ANY16
	ZP.REMTO	Target network number	1 to 239	String	ANY16_OR_STRING_SINGLE
(s1)		Channel of the own station, which is used for the instruction ^{*1}	1 to 32	16-bit unsigned binary	ANY16
(s2)		Target station number	1 to 120	16-bit unsigned binary	ANY16
(s3)		Start I/O number of target station	00H (fixed)	16-bit unsigned binary	ANY16
(s4)		Start address of the buffer memory area of the remote station where the data is written	0000H to FFFFH (0 to 65535)	16-bit unsigned binary	ANY16
(s5)		Start device of the own station, where the write-target data is stored	—	Device name	ANY16 ^{*2}
(n)		Number of write data points (in units of words)	1 to 240	16-bit unsigned binary	ANY16
(d)		Device of the own station, which turns on for one scan upon completion of the instruction. When the instruction completes with an error, (d)+1 also turns on.	—	Bit	ANYBIT_ARRAY (Number of elements: 2)
EN		Execution condition	—	Bit	BOOL
ENO		Execution result	—	Bit	BOOL

*1 A channel is used for the REMFR, REMTO, REMFRD, REMTOD, REMFRIP, REMTOIP, REMFRDIP, and REMTODIP instructions. The same channel number used for the link dedicated instructions (such as the READ instruction) can be set.

*2 When specifying data with a label, define the array so that an area required for operation can be secured, and specify the array label element.

Point

Use the REMTOD or REMTODIP instruction if the start address of the buffer memory area (s4) exceeds FFFFH (65535).

■Applicable devices

Operand	Bit	Word				Double word		Indirect specification	Constant			Others (J)	
		X, Y, M, L, SM, F, B, SB, FX, FY	J□□□	T, ST, C, D, W, SD, SW, FD, R, ZR, RD	U□□G□, J□□□, U3E□(H)G□	Z	LT, LST, LC		LZ	K, H	E		\$
(J)	JP.REMTO	—	—	—	—	—	—	—	—	—	—	—	○
	ZP.REMTO	—	—	—	—	—	—	—	—	—	—	○	○
(s1)	○ ^{*1}	—	○ ^{*2}	—	—	—	○	○	—	—	—	—	
(s2)	○ ^{*1}	—	○ ^{*2}	—	—	—	○	○	—	—	—	—	
(s3)	○ ^{*1}	—	○ ^{*2}	—	—	—	○	○	—	—	—	—	
(s4)	○ ^{*1}	—	○ ^{*2}	—	—	—	○	○	—	—	—	—	
(s5)	—	—	○ ^{*2}	—	—	—	○	—	—	—	—	—	
(n)	○ ^{*1}	—	○ ^{*2}	—	—	—	○	○	—	—	—	—	
(d)	○ ^{*1}	—	○ ^{*3}	—	—	—	—	—	—	—	—	—	

*1 FX and FY cannot be used.

*2 FD cannot be used.

*3 T, ST, C, and FD cannot be used.

Processing details

- These instructions write the data from the start device (s5) of the own station to the buffer memory areas ((s4) and later) of the remote station for the specified number of words (n). Specify the target station by using (J), (s2), and (s3). The completion device (d) turns on upon completion of the instruction.

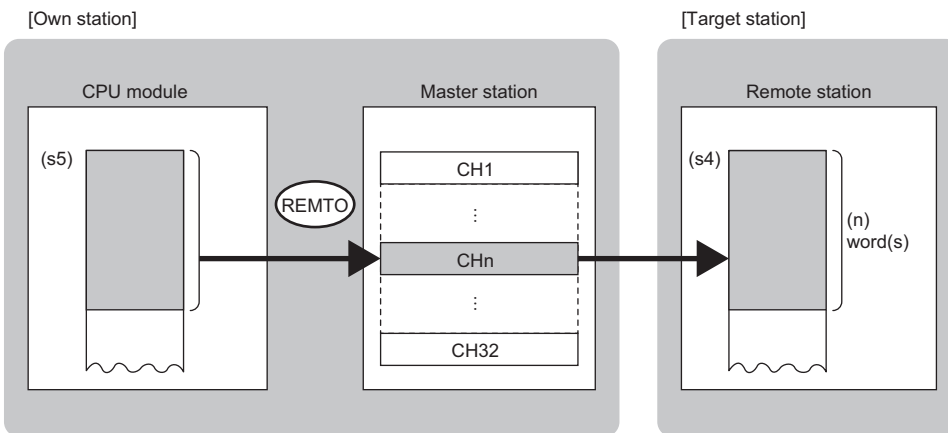

CH: Channel

- The execution status and the completion status of the REMTO instruction can be checked with the completion device (d) and the completion status indication device (d)+1.
 - Completion device (d)
This device turns on during END processing of the scan where the REMTO instruction completes, and turns off during the next END processing.
 - Completion status indication device (d)+1
This device turns on or off depending on the completion status of the REMTO instruction.
When completed successfully: The device remains off.
When completed with an error: The device turns on during END processing of the scan where the REMTO instruction completes, and turns off during the next END processing.

- The following figures show how the REMTO instruction operates when its execution has completed.
- When completed successfully

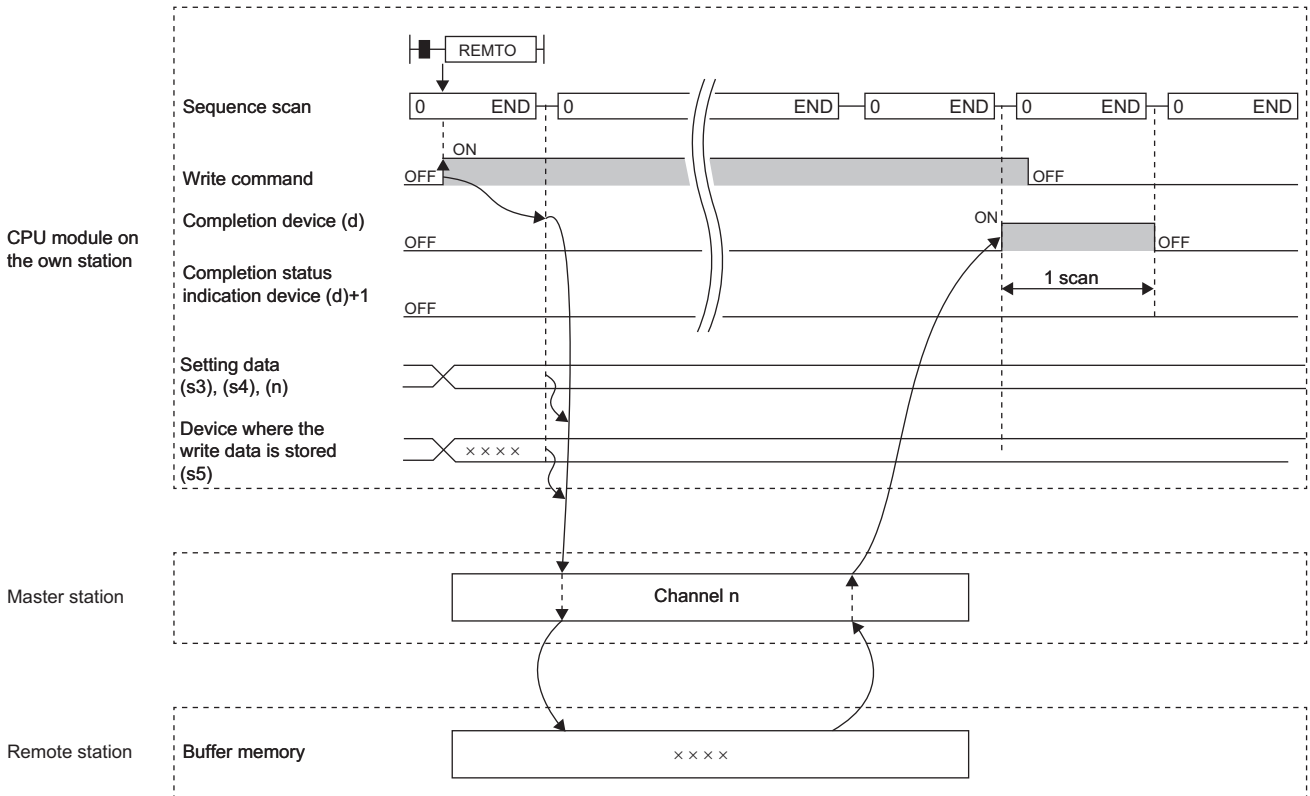

- When completed with an error

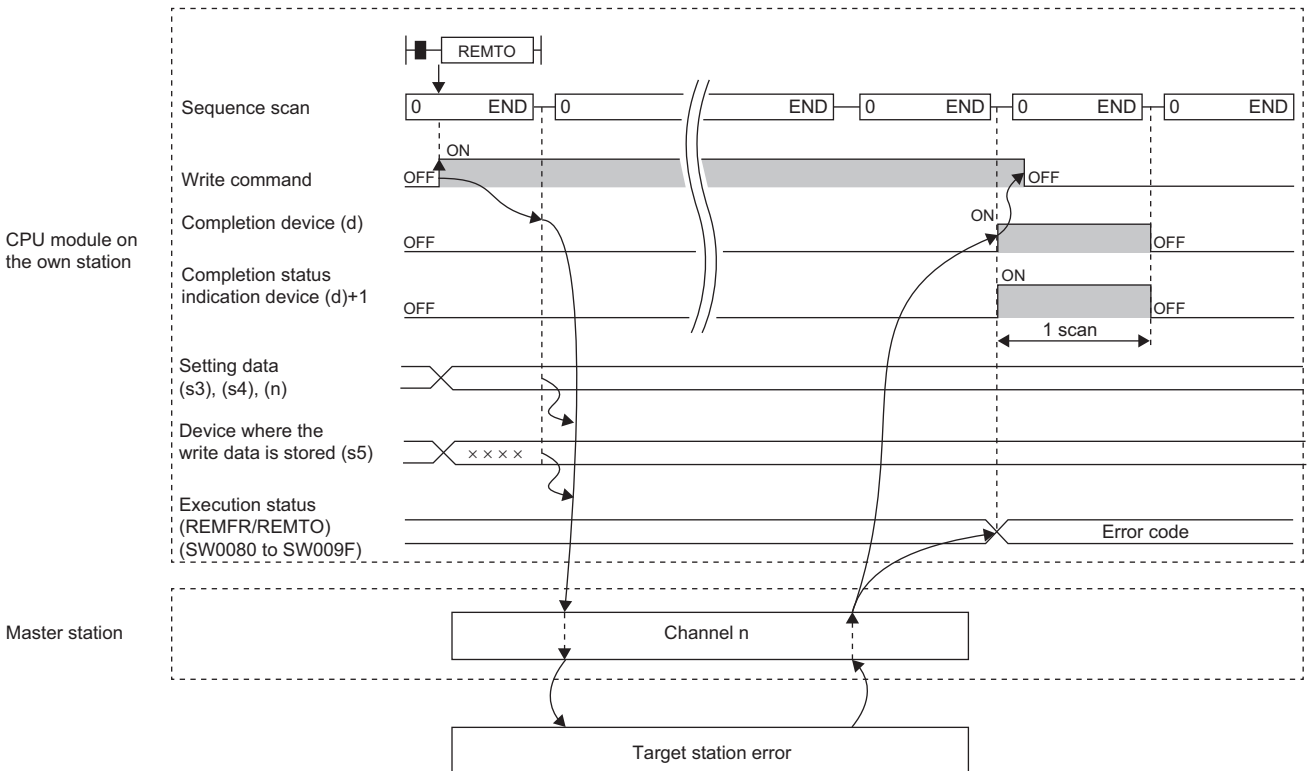

For the REMTO instruction, the number of resends and the response wait timer can be set in the following link special register (SW) areas.

- Number of resends (REMFR/REMTO) (SW001A)
- Response wait timer (REMFR/REMTO) (SW001B)

If the number of resends (REMFR/REMTO) (SW001A) is set, the REMTO instruction completes with an error after the following time has elapsed:

(Number of resends (REMFR/REMTO) + 1) × Response wait timer (REMFR/REMTO)



Note, however, that no retry is performed if the target station is disconnected at the REMTO instruction execution. If the REMTO instruction completes with an error, execute the instruction again after the target station returns to the system.

Precautions

For the REMTO instruction, check the following before using the instruction.

- The REMTO instruction can be used in the target station.
- The area can be accessed in the target station.

Operation error

Error code (SW0080 to SW009F)	Description
4000H to 4FFFH	 Refer to the manual of the target station connected.
C000H to CFFFH D000H to DFFFH E000H to EFFFH	 MELSEC iQ-R CC-Link IE TSN User's Manual (Application)

5.3 Reading Data from the Remote Station (32-bit Address Specified)

JP.REMFRD

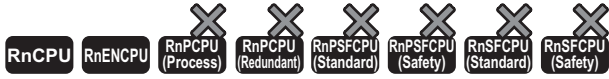

These instructions read data from the buffer memory of the remote station. (in units of words, 32-bit address specified).

Ladder	ST
	ENO:=JP_REMFRD(EN,J,s1,s2,s3,s4,n,d1,d2);

FBD/LD

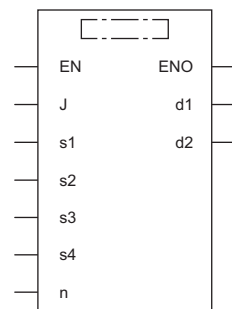

Execution condition

Instruction	Execution condition
JP.REMFRD	

Setting data

■Description, range, data type

Operand	Description	Range	Data type	Data type (label)
(J)	Target network number	1 to 239	16-bit unsigned binary	ANY16
(s1)	Channel of the own station, which is used for the instruction ^{*1}	1 to 32	16-bit unsigned binary	ANY16
(s2)	Target station number	1 to 120	16-bit unsigned binary	ANY16
(s3)	Start I/O number of target station	00H (fixed)	16-bit unsigned binary	ANY16
(s4)	Start address of the buffer memory area of the remote device station where the read-target data is stored	00000000H to FFFFFFFFH (0 to 4294967295)	32-bit unsigned binary	ANY32
(d1)	Start device of the own station for storing the read data	—	Device name	ANY16 ^{*2}
(n)	Number of read data points (in units of words)	1 to 240	16-bit unsigned binary	ANY16
(d2)	Device of the own station, which turns on for one scan upon completion of the instruction. When the instruction completes with an error, (d2)+1 also turns on.	—	Bit	ANYBIT_ARRAY (Number of elements: 2)
EN	Execution condition	—	Bit	BOOL
ENO	Execution result	—	Bit	BOOL

*1 A channel is used for the REMFR, REMTO, REMFRD, REMTOD, REMFRIP, REMTOIP, REMFRDIP, and REMTODIP instructions. The same channel number used for the link dedicated instructions (such as the READ instruction) can be set.

*2 When specifying data with a label, define the array so that an area required for operation can be secured, and specify the array label element.

■Applicable devices

Operand	Bit		Word			Double word		Indirect specification	Constant			Others (J)
	X, Y, M, L, SM, F, B, SB, FX, FY	J□□	T, ST, C, D, W, SD, SW, FD, R, ZR, RD	U□□G□, J□□□, U3E□□(H)G□	Z	LT, LST, LC	LZ		K, H	E	\$	
(J)	—	—	—	—	—	—	—	—	—	—	—	○
(s1)	○ ^{*1}	—	○ ^{*2}	—	—	—	○	○	—	—	—	—
(s2)	○ ^{*1}	—	○ ^{*2}	—	—	—	○	○	—	—	—	—
(s3)	○ ^{*1}	—	○ ^{*2}	—	—	—	○	○	—	—	—	—
(s4)	○ ^{*1}	—	○ ^{*2}	—	○	—	○	○	—	—	—	—
(d1)	—	—	○ ^{*2}	—	—	—	○	—	—	—	—	—
(n)	○ ^{*1}	—	○ ^{*2}	—	—	—	○	○	—	—	—	—
(d2)	○ ^{*1}	—	○ ^{*3}	—	—	—	—	—	—	—	—	—

*1 FX and FY cannot be used.

*2 FD cannot be used.

*3 T, ST, C, and FD cannot be used.

Processing details

- This instruction reads the data from the start address (s4) of the buffer memory area of the remote station to the word device ((d1) and later) of the own station for the specified number of words (n). Specify the target station by using (J), (s2), and (s3). The completion device (d2) turns on upon completion of the instruction.

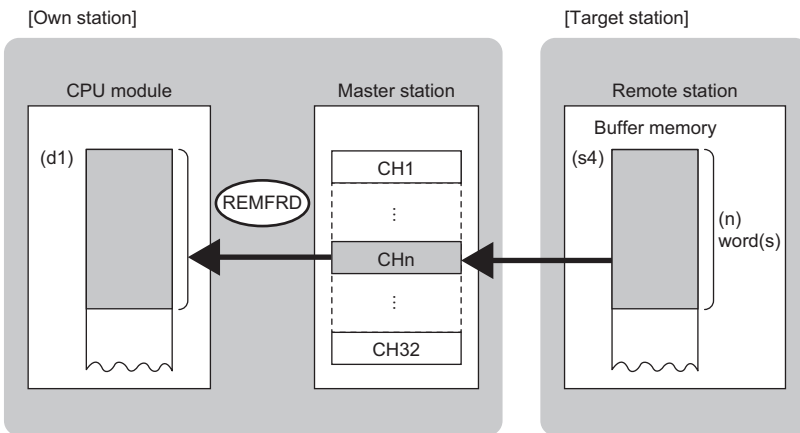

CH: Channel

- The execution status and the completion status of the REMFRD instruction can be checked with the completion device (d2) and the completion status indication device (d2)+1.

- Completion device (d2)

This device turns on during END processing of the scan where the REMFRD instruction completes, and turns off during the next END processing.

- Completion status indication device (d2)+1

This device turns on or off depending on the completion status of the REMFRD instruction.

When completed successfully: The device remains off.

When completed with an error: The device turns on during END processing of the scan where the REMFRD instruction completes, and turns off during the next END processing.

- The following figures show how the REMFRD instruction operates when its execution has completed.
- When completed successfully

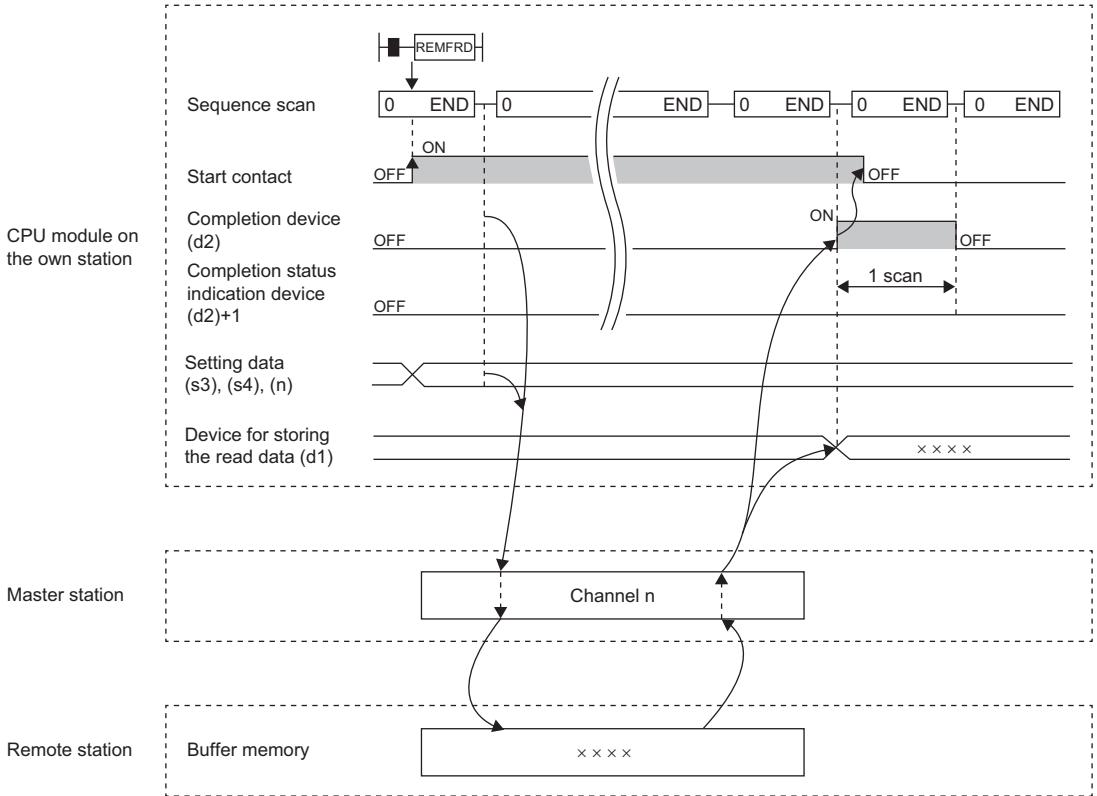

- When completed with an error

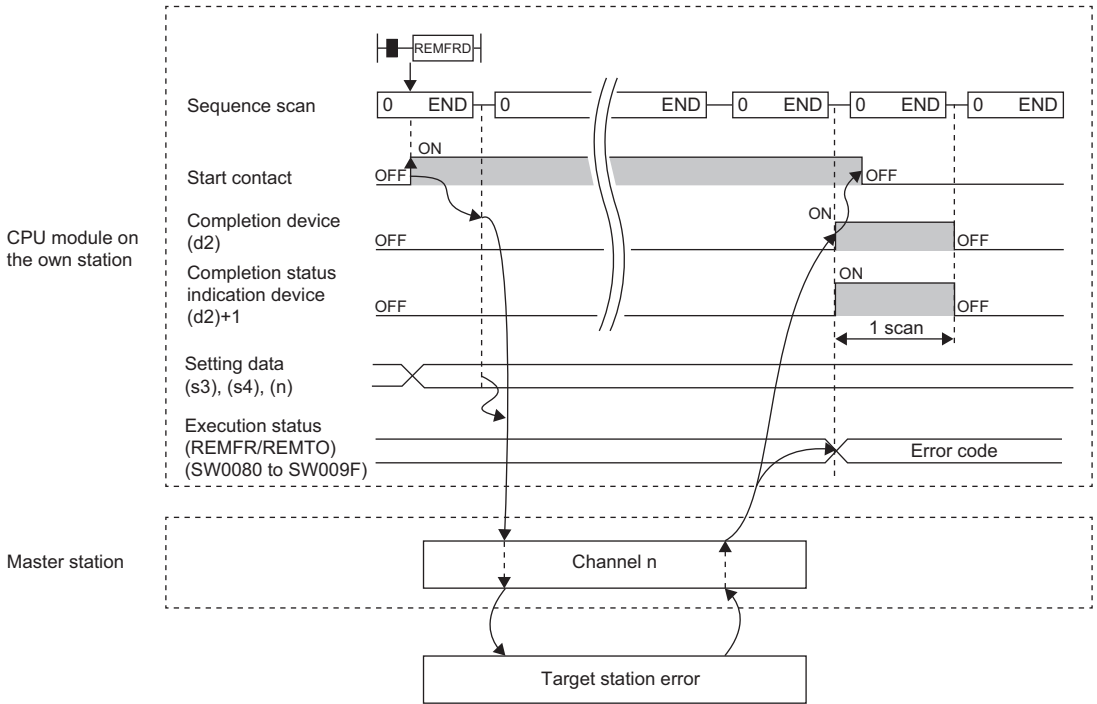

For the REMFRD instruction, the number of resends and the response wait timer can be set in the following link special register (SW) areas.

- Number of resends (REMFR/REMTO) (SW001A)
- Response wait timer (REMFR/REMTO) (SW001B)

If the number of resends (REMFR/REMTO) (SW001A) is set, the REMFRD instruction completes with an error after the following time has elapsed:

(Number of resends (REMFR/REMTO) + 1) × Response wait timer (REMFR/REMTO)



Note, however, that no retry is performed if the target station is disconnected at the REMFRD instruction execution. If the REMFRD instruction completes with an error, execute the instruction again after the target station returns to the system.

Precautions

For the REMFRD instruction, check the following before using the instruction.

- The REMFRD instruction can be used in the target station.
- The area can be accessed in the target station.

Operation error

Error code (SW0080 to SW009F)	Description
4000H to 4FFFH	 Refer to the manual of the target station connected.
C000H to CFFFH D000H to DFFFH E000H to EFFFH	 MELSEC iQ-R CC-Link IE TSN User's Manual (Application)

5.4 Writing Data to the Remote Station (32-bit Address Specified)

JP.REMTOD

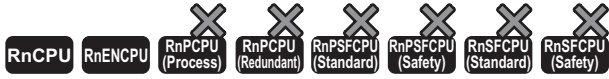

These instructions write data to the buffer memory area of the remote station. (in units of words, 32-bit address specified).

Ladder	ST
	<pre>ENO:=JP_REMTOD(EN,J,s1,s2,s3,s4,s5,n,d);</pre>

FBD/LD

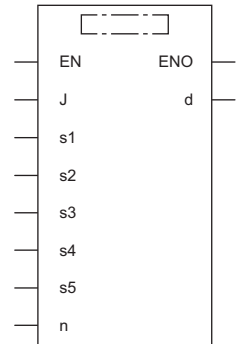

Execution condition

Instruction	Execution condition
JP.REMTOD	

Setting data

■Description, range, data type

Operand	Description	Range	Data type	Data type (label)
(J)	Target network number	1 to 239	16-bit unsigned binary	ANY16
(s1)	Channel of the own station, which is used for the instruction ^{*1}	1 to 32	16-bit unsigned binary	ANY16
(s2)	Target station number	1 to 120	16-bit unsigned binary	ANY16
(s3)	Start I/O number of target station	00H (fixed)	16-bit unsigned binary	ANY16
(s4)	Start address of the buffer memory area of the remote station where the data is written	00000000H to FFFFFFFFH (0 to 4294967295)	32-bit unsigned binary	ANY32
(s5)	Start device of the own station, where the write-target data is stored	—	Device name	ANY16 ^{*2}
(n)	Number of write data points (in units of words)	1 to 240	16-bit unsigned binary	ANY16
(d)	Device of the own station, which turns on for one scan upon completion of the instruction. When the instruction completes with an error, (d)+1 also turns on.	—	Bit	ANYBIT_ARRAY (Number of elements: 2)
EN	Execution condition	—	Bit	BOOL
ENO	Execution result	—	Bit	BOOL

*1 A channel is used for the REMFR, REMTO, REMFRD, REMTOD, REMFRIP, REMTOIP, REMFRDIP, and REMTODIP instructions. The same channel number used for the link dedicated instructions (such as the READ instruction) can be set.

*2 When specifying data with a label, define the array so that an area required for operation can be secured, and specify the array label element.

■Applicable devices

Operand	Bit		Word				Double word		Indirect specification	Constant			Others (J)
	X, Y, M, L, SM, F, B, SB, FX, FY	J□□□	T, ST, C, D, W, SD, SW, FD, R, ZR, RD	U□□G□, J□□□, U3E□□(H)G□	Z	LT, LST, LC	LZ	K, H, E, \$					
(J)	—	—	—	—	—	—	—	—	—	—	—	—	○
(s1)	○ ^{*1}	—	○ ^{*2}	—	—	—	—	○	○	—	—	—	—
(s2)	○ ^{*1}	—	○ ^{*2}	—	—	—	—	○	○	—	—	—	—
(s3)	○ ^{*1}	—	○ ^{*2}	—	—	—	—	○	○	—	—	—	—
(s4)	○ ^{*1}	—	○ ^{*2}	—	—	○	—	○	○	—	—	—	—
(s5)	—	—	○ ^{*2}	—	—	—	—	○	—	—	—	—	—
(n)	○ ^{*1}	—	○ ^{*2}	—	—	—	—	○	○	—	—	—	—
(d)	○ ^{*1}	—	○ ^{*3}	—	—	—	—	—	—	—	—	—	—

*1 FX and FY cannot be used.

*2 FD cannot be used.

*3 T, ST, C, and FD cannot be used.

Processing details

- These instructions write the data from the start device (s5) of the own station to the buffer memory areas ((s4) and later) of the remote station for the specified number of words (n). Specify the target station by using (J), (s2), and (s3). The completion device (d) turns on upon completion of the instruction.

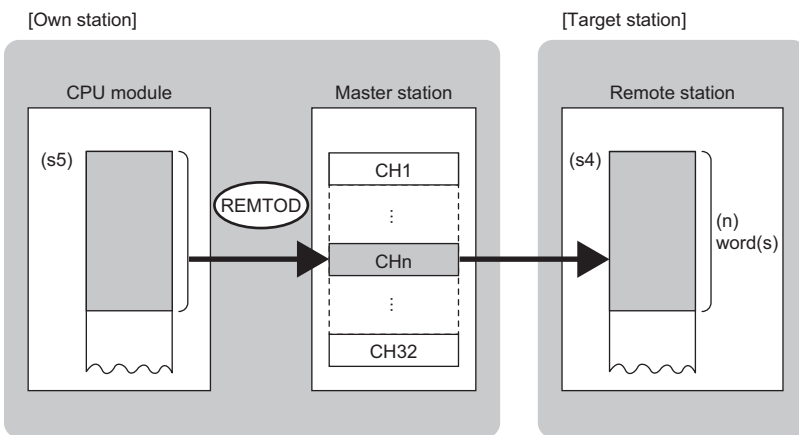

CH: Channel

- The execution status and the completion status of the REMTOD instruction can be checked with the completion device (d) and the completion status indication device (d)+1.

- Completion device (d)

This device turns on during END processing of the scan where the REMTOD instruction completes, and turns off during the next END processing.

- Completion status indication device (d)+1

This device turns on or off depending on the completion status of the REMTOD instruction.

When completed successfully: The device remains off.

When completed with an error: The device turns on during END processing of the scan where the REMTOD instruction completes, and turns off during the next END processing.

- The following figures show how the REMTOD instruction operates when its execution has completed.
- When completed successfully

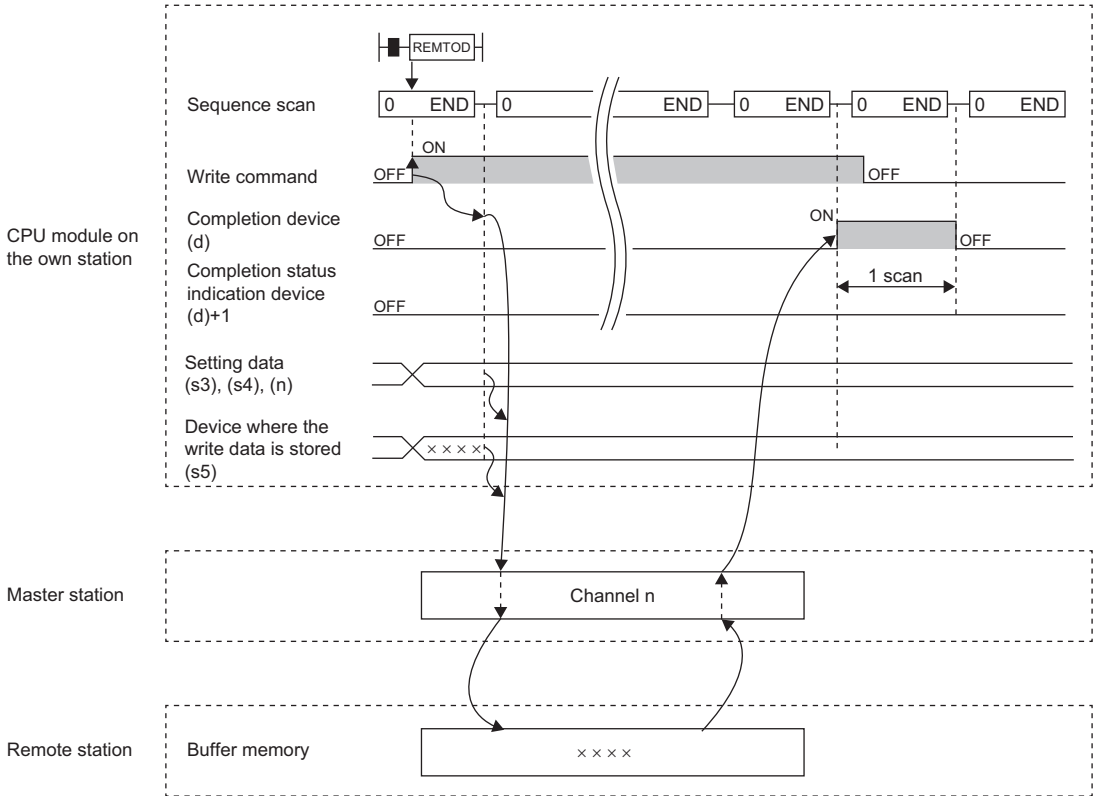

- When completed with an error

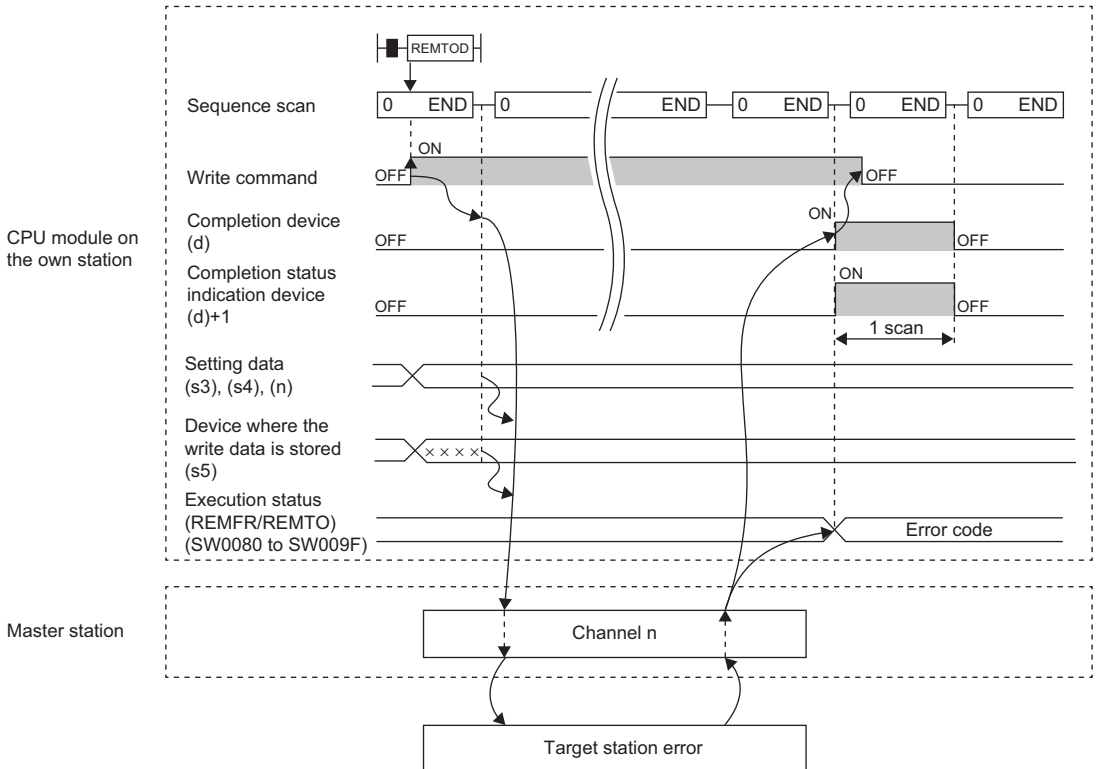

For the REMTOD instruction, the number of resends and the response wait timer can be set in the following link special register (SW) areas.

- Number of resends (REMFR/REMTO) (SW001A)
- Response wait timer (REMFR/REMTO) (SW001B)

If the number of resends (REMFR/REMTO) (SW001A) is set, the REMTOD instruction completes with an error after the following time has elapsed:

(Number of resends (REMFR/REMTO) + 1) × Response wait timer (REMFR/REMTO)



Note, however, that no retry is performed if the target station is disconnected at the REMTOD instruction execution. If the REMTOD instruction completes with an error, execute the instruction again after the target station returns to the system.

Precautions

For the REMTOD instruction, check the following before using the instruction.

- The REMTOD instruction can be used in the target station.
- The area can be accessed in the target station.

Operation error

Error code (SW0080 to SW009F)	Description
4000H to 4FFFH	 Refer to the manual of the target station connected.
C000H to CFFFH D000H to DFFFH E000H to EFFFH	 MELSEC iQ-R CC-Link IE TSN User's Manual (Application)

5.5 Reading Data from the Remote Station (16-bit Address Specified)

GP.REMFRIP

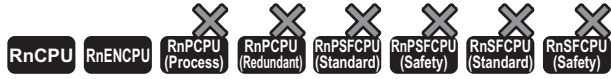

These instructions read data from the buffer memory of the remote station. (in units of words, 16-bit address specified). The target station is also specified by the IP address.

Ladder	ST
	<pre>ENO:=GP_REMFRIP(EN,U,s1,s2,d1,d2);</pre>

FBD/LD

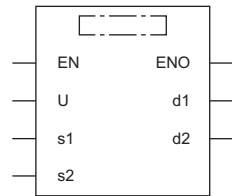

Execution condition

Instruction	Execution condition
GP.REMFRIP	

Setting data

Description, range, data type

Operand	Description	Range	Data type	Data type (label)
(U)	Start I/O number (first three digits in four-digit hexadecimal representation) of own station or own node	00H to FEH	16-bit unsigned binary	ANY16
(s1)	Own station start device where control data is stored	Page 233 Control data	Device name	ANY16 ^{*1}
(s2)	Start address of the buffer memory area of the remote device station where the read-target data is stored	0000H to FFFFH (0 to 65535)	16-bit unsigned binary	ANY16
(d1)	Start device of the own station for storing the read data	—	Device name	ANY16
(d2)	Device of the own station, which turns on for one scan upon completion of the instruction. When the instruction completes with an error, (d2)+1 also turns on.	—	Bit	ANYBIT_ARRAY (Number of elements: 2)
EN	Execution condition	—	Bit	BOOL
ENO	Execution result	—	Bit	BOOL

*1 When specifying data with a label, define the array so that an area required for operation can be secured, and specify the array label element.

Point

Use the REMFRDIP instruction if the start address of the buffer memory area (s2) exceeds FFFFH (65535).

■Applicable devices

Operand	Bit		Word			Double word		Indirect specification	Constant			Others (U)
	X, Y, M, L, SM, F, B, SB, FX, FY	J□□	T, ST, C, D, W, SD, SW, FD, R, ZR, RD	U□V□, J□□, U3E□(H)G□	Z	LT, LST, LC	LZ		K, H	E	\$	
(U)	—	—	○	—	—	—	○	○	—	—	○	
(s1)	—	—	○*2	—	—	—	○	—	—	—	—	
(s2)	○*1	—	○*2	—	—	—	○	○	—	—	—	
(d1)	—	—	○*2	—	—	—	○	—	—	—	—	
(d2)	○*1	—	○*3	—	—	—	—	—	—	—	—	

*1 FX and FY cannot be used.

*2 FD cannot be used.

*3 T, ST, C, and FD cannot be used.

■Control data

Operand: (s1)				
Device	Item	Description	Setting range	Set by
+0	Execution/error completion type	b15 b14 ... b0 (1) <input type="text" value="0"/> (1) Target station address specification method (b15) • 0: Specify "network No." in (s1)+4, and "station number" in (s1)+5. • 1: Specify "IP address" in (s1)+4, 5	0000H 8000H	User
+1	Completion status	The instruction completion status is stored. • 0: Completed successfully • Other than 0: Completed with an error (error code)	—	System
+2	Own station channel ¹	Specify the channel of the own station which is used for the instruction.	1 to 32	User
+3	Start I/O number of target station	Specify the start I/O number of the target station.	0000H (fixed)	User
+4	Target network number	■When "0" is specified in bit 15 of (s1)+0 Specify the network number (1 to 239) of the target station. ■When "1" is specified in bit 15 of (s1)+0 Specify the IP address (third and fourth octets) of the target station. b15 ... b8 b7 ... b0 <input type="text"/> • b8 to b15: 3rd octet • b0 to b7: 4th octet	■(s1)+4 • Network number: 1 to 239 ■(s1)+5 • Station number: 1 to 120 ■(s1)+4, 5 • IP address: 00000001H to DFFFFFFEH	User
+5	Target station number	■When "0" is specified in bit 15 of (s1)+0 Specify the station number of the target station. • 1 to 120 ■When "1" is specified in bit 15 of (s1)+0 Specify the IP address (first and second octets) of the target station. b15 ... b8 b7 ... b0 <input type="text"/> • b8 to b15: 1st octet • b0 to b7: 2nd octet	00000001H to DFFFFFFEH	User
+6	Not used	—	—	—
+7	Number of resends	■Before instruction execution Specify the number of resends to be performed if the instruction is not completed within the monitoring time specified by (s1)+8. • 0 to 15 times ■At completion of instruction The number of resends performed (result) is stored. • 0 to 15 times ²	0 to 15	User/system
+8	Arrival monitoring time	Specify the monitoring time until completion of processing. If processing is not completed within the monitoring time, the request is resent by the number of resends specified in (s1)+7. • 0: 10s • 1 to 32767: 1 to 32767s	0 to 32767	User
+9	Read data length	Specify the number of words to be read.	1 to 240	User

Operand: (s1)				
Device	Item	Description	Setting range	Set by
+10 to +17	Not used	—	—	—

*1 A channel is used for the REMFR, REMTO, REMFRD, REMTOD, REMFRIP, REMTOIP, REMFRDIP, and REMTODIP instructions. The same channel number used for the link dedicated instructions (such as the READ instruction) can be set.

*2 If an error was detected, the number of resends performed (result) between error detection and resend stop is stored.

Processing details

- This instruction reads the data from the start address (s2) of the buffer memory area of the remote station to the word device ((d1) and later) of the own station for the specified number of words ((s1)+9). Specify the target station by using (U) and (s1)+3 to (s1)+5. The completion device (d2) turns on upon completion of the instruction.

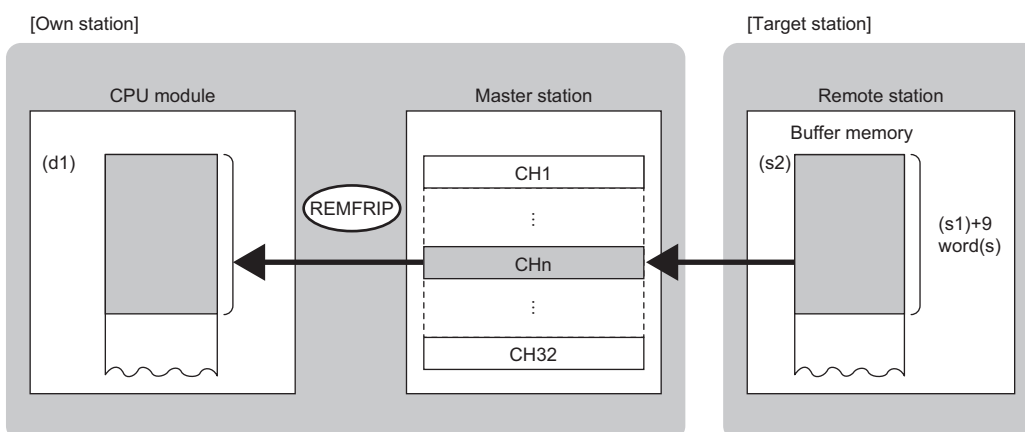

CH: Channel

- The execution status and the completion status of the REMFRIP instruction can be checked with the completion device (d2) and the completion status indication device (d2)+1.

- Completion device (d2)

This device turns on during END processing of the scan where the REMFRIP instruction completes, and turns off during the next END processing.

- Completion status indication device (d2)+1

This device turns on or off depending on the completion status of the REMFRIP instruction.

When completed successfully: The device remains off.

When completed with an error: The device turns on during END processing of the scan where the REMFRIP instruction completes, and turns off during the next END processing.

Precautions

For the REMFRIP instruction, check the following before using the instruction.

- The REMFRIP instruction can be used in the target station.
- The area can be accessed in the target station.

Operation error

Error code ((s1)+1)	Description
4000H to 4FFFH	Refer to the manual of the target station connected.
C000H to CFFFH D000H to DFFFH E000H to EFFFH	MELSEC iQ-R CC-Link IE TSN User's Manual (Application)

5.6 Writing Data to the Remote Station (Target Station IP Address Specified) (16-bit Address Specified)

GP.REMTOIP

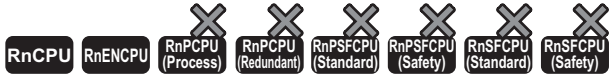

These instructions write data to the buffer memory area of the remote station. (in units of words, 16-bit address specified). The target station is also specified by the IP address.

Ladder	ST
	<pre>ENO:=GP_REMTOIP(EN,U,s1,s2,d1,d2);</pre>

FBD/LD

Execution condition

Instruction	Execution condition
GP.REMTOIP	

Setting data

Description, range, data type

Operand	Description	Range	Data type	Data type (label)
(U)	Start I/O number (first three digits in four-digit hexadecimal representation) of own station or own node	00H to FEH	16-bit unsigned binary	ANY16
(s1)	Own station start device where control data is stored	☞ Page 236 Control data	Device name	ANY16 ^{*1}
(s2)	Start device of the own station, where the write-target data is stored	—	Device name	ANY16 ^{*1}
(d1)	Start address of the buffer memory area of the remote station where the data is written	0000H to FFFFH (0 to 65535)	16-bit unsigned binary	ANY16
(d2)	Device of the own station, which turns on for one scan upon completion of the instruction. When the instruction completes with an error, (d2)+1 also turns on.	—	Bit	ANYBIT_ARRAY (Number of elements: 2)
EN	Execution condition	—	Bit	BOOL
ENO	Execution result	—	Bit	BOOL

*1 When specifying data with a label, define the array so that an area required for operation can be secured, and specify the array label element.



Use the REMTODIP instruction if the start address of the buffer memory area (d1) exceeds FFFFH (65535).

■Applicable devices

Operand	Bit		Word			Double word		Indirect specification	Constant			Others (U)
	X, Y, M, L, SM, F, B, SB, FX, FY	J□□	T, ST, C, D, W, SD, SW, FD, R, ZR, RD	U□V□, J□□, U3E□(H)G□	Z	LT, LST, LC	LZ		K, H	E	\$	
(U)	—	—	○	—	—	—	○	○	—	—	○	
(s1)	—	—	○*2	—	—	—	○	—	—	—	—	
(s2)	—	—	○*2	—	—	—	○	—	—	—	—	
(d1)	○*1	—	○*2	—	—	—	○	○	—	—	—	
(d2)	○*1	—	○*3	—	—	—	—	—	—	—	—	

*1 FX and FY cannot be used.

*2 FD cannot be used.

*3 T, ST, C, and FD cannot be used.

■Control data

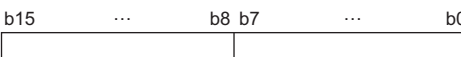
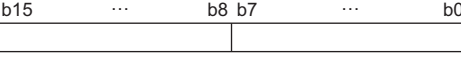
Operand: (s1)				
Device	Item	Description	Setting range	Set by
+0	Execution/error completion type	b15 b14 ... b0  <p>(1) Target station address specification method (b15)</p> <ul style="list-style-type: none"> • 0: Specify "network No." in (s1)+4, and "station number" in (s1)+5. • 1: Specify "IP address" in (s1)+4, 5 	0000H 8000H	User
+1	Completion status	The instruction completion status is stored. <ul style="list-style-type: none"> • 0: Completed successfully • Other than 0: Completed with an error (error code) 	—	System
+2	Own station channel ^{*1}	Specify the channel of the own station which is used for the instruction.	1 to 32	User
+3	Start I/O number of target station	Specify the start I/O number of the target station.	0000H (fixed)	User
+4	Target network number	■When "0" is specified in bit 15 of (s1)+0 Specify the network number (1 to 239) of the target station. ■When "1" is specified in bit 15 of (s1)+0 Specify the IP address (third and fourth octets) of the target station. b15 ... b8 b7 ... b0  <ul style="list-style-type: none"> • b8 to b15: 3rd octet • b0 to b7: 4th octet 	■(s1)+4 • Network number: 1 to 239 ■(s1)+5 • Station number: 1 to 120 ■(s1)+4, 5 • IP address: 00000001H to DFFFFFFEH	User
+5	Target station number	■When "0" is specified in bit 15 of (s1)+0 Specify the station number of the target station. <ul style="list-style-type: none"> • 1 to 120 ■When "1" is specified in bit 15 of (s1)+0 Specify the IP address (first and second octets) of the target station. b15 ... b8 b7 ... b0  <ul style="list-style-type: none"> • b8 to b15: 1st octet • b0 to b7: 2nd octet 	00000001H to DFFFFFFEH	User
+6	Not used	—	—	—
+7	Number of resends	■Before instruction execution Specify the number of resends to be performed if the instruction is not completed within the monitoring time specified by (s1)+8. <ul style="list-style-type: none"> • 0 to 15 times ■At completion of instruction The number of resends performed (result) is stored. <ul style="list-style-type: none"> • 0 to 15 times^{*2} 	0 to 15	User/system
+8	Arrival monitoring time	Specify the monitoring time until completion of processing. If processing is not completed within the monitoring time, the request is resent by the number of resends specified in (s1)+7. <ul style="list-style-type: none"> • 0: 10s • 1 to 32767: 1 to 32767s 	0 to 32767	User
+9	Write data length	Specify the number of words to be written.	1 to 240	User

Operand: (s1)				
Device	Item	Description	Setting range	Set by
+10 to +17	Not used	—	—	—

*1 A channel is used for the REMFR, REMTO, REMFRD, REMTOD, REMFRIP, REMTOIP, REMFRDIP, and REMTODIP instructions. The same channel number used for the link dedicated instructions (such as the READ instruction) can be set.

*2 If an error was detected, the number of resends performed (result) between error detection and resend stop is stored.

Processing details

- These instructions write the data from the start device (s2) of the own station to the buffer memory areas ((d1) and later) of the remote station for the specified number of words ((s1)+9). Specify the target station by using (U) and (s1)+3 to (s1)+5. The completion device (d2) turns on upon completion of the instruction.

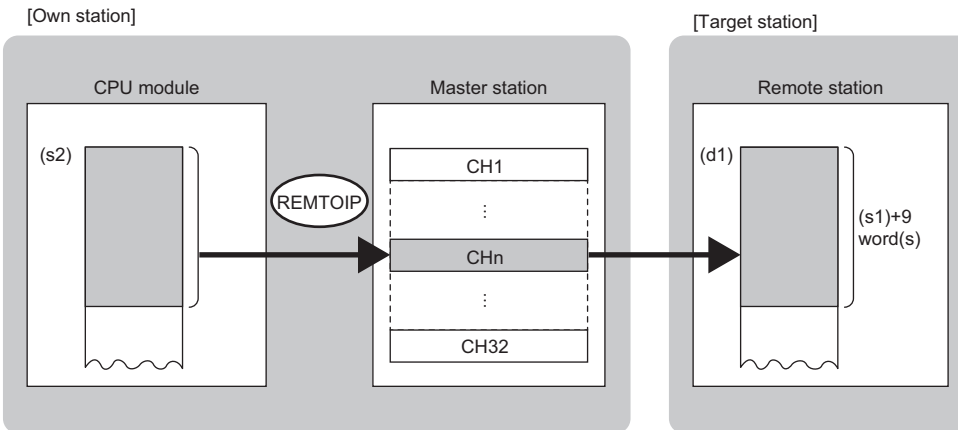

CH: Channel

- The execution status and the completion status of the REMTOIP instruction can be checked with the completion device (d2) and the completion status indication device (d2)+1.

- Completion device (d2)

This device turns on during END processing of the scan where the REMTOIP instruction completes, and turns off during the next END processing.

- Completion status indication device (d2)+1

This device turns on or off depending on the completion status of the REMTOIP instruction.

When completed successfully: The device remains off.

When completed with an error: The device turns on during END processing of the scan where the REMTOIP instruction completes, and turns off during the next END processing.

Precautions

For the REMTOIP instruction, check the following before using the instruction.

- The REMTOIP instruction can be used in the target station.
- The area can be accessed in the target station.

Operation error

Error code ((s1)+1)	Description
4000H to 4FFFH	Refer to the manual of the target station connected.
C000H to CFFFH D000H to DFFFH E000H to EFFFH	MELSEC iQ-R CC-Link IE TSN User's Manual (Application)

5.7 Reading Data from the Remote Station (Target Station IP Address Specified) (32-bit Address Specified)

GP.REMFRDIP



These instructions read data from the buffer memory of the remote station. (in units of words, 32-bit address specified). The target station is also specified by the IP address.

Ladder	ST
	<pre>ENO:=GP_REMFRDIP(EN,U,s1,s2,d1,d2);</pre>

FBD/LD

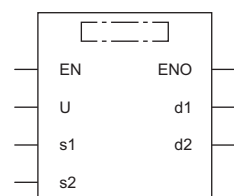

Execution condition

Instruction	Execution condition
GP.REMFRDIP	

Setting data

Description, range, data type

Operand	Description	Range	Data type	Data type (label)
(U)	Start I/O number (first three digits in four-digit hexadecimal representation) of own station or own node	00H to FEH	16-bit unsigned binary	ANY16
(s1)	Own station start device where control data is stored	Page 239 Control data	Device name	ANY16 ^{*1}
(s2)	Start address of the buffer memory area of the remote device station where the read-target data is stored	00000000H to FFFFFFFFH (0 to 4294967295)	32-bit unsigned binary	ANY32
(d1)	Start device of the own station for storing the read data	—	Device name	ANY16
(d2)	Device of the own station, which turns on for one scan upon completion of the instruction. When the instruction completes with an error, (d2)+1 also turns on.	—	Bit	ANYBIT_ARRAY (Number of elements: 2)
EN	Execution condition	—	Bit	BOOL
ENO	Execution result	—	Bit	BOOL

*1 When specifying data with a label, define the array so that an area required for operation can be secured, and specify the array label element.

■Applicable devices

Operand	Bit		Word			Double word		Indirect specification	Constant				Others (U)
	X, Y, M, L, SM, F, B, SB, FX, FY	J□□	T, ST, C, D, W, SD, SW, FD, R, ZR, RD	U□\G□, J□□□, U3E□(H)G□	Z	LT, LST, LC	LZ		K, H	E	\$		
(U)	—	—	○	—	—	—	○	○	—	—	○		
(s1)	—	—	○*2	—	—	—	○	—	—	—	—		
(s2)	○*1	—	○*2	—	—	○	○	○	—	—	—		
(d1)	—	—	○*2	—	—	—	○	—	—	—	—		
(d2)	○*1	—	○*3	—	—	—	—	—	—	—	—		

*1 FX and FY cannot be used.

*2 FD cannot be used.

*3 T, ST, C, and FD cannot be used.

■Control data

Operand: (s1)				
Device	Item	Description	Setting range	Set by
+0	Execution/error completion type	b15 b14 ... b0 (1) <input type="text" value="0"/> <p>(1) Target station address specification method (b15)</p> <ul style="list-style-type: none"> • 0: Specify "network No." in (s1)+4, and "station number" in (s1)+5. • 1: Specify "IP address" in (s1)+4, 5 	0000H 8000H	User
+1	Completion status	The instruction completion status is stored. <ul style="list-style-type: none"> • 0: Completed successfully • Other than 0: Completed with an error (error code) 	—	System
+2	Own station channel*1	Specify the channel of the own station which is used for the instruction.	1 to 32	User
+3	Start I/O number of target station	Specify the start I/O number of the target station.	0000H (fixed)	User
+4	Target network number	■When "0" is specified in bit 15 of (s1)+0 Specify the network number (1 to 239) of the target station. ■When "1" is specified in bit 15 of (s1)+0 Specify the IP address (third and fourth octets) of the target station. b15 ... b8 b7 ... b0 <input type="text"/> <ul style="list-style-type: none"> • b8 to b15: 3rd octet • b0 to b7: 4th octet 	■(s1)+4 • Network number: 1 to 239 ■(s1)+5 • Station number: 1 to 120 ■(s1)+4, 5 • IP address: 00000001H to DFFFFFFEH	User
+5	Target station number	■When "0" is specified in bit 15 of (s1)+0 Specify the station number of the target station. • 1 to 120 ■When "1" is specified in bit 15 of (s1)+0 Specify the IP address (first and second octets) of the target station. b15 ... b8 b7 ... b0 <input type="text"/> <ul style="list-style-type: none"> • b8 to b15: 1st octet • b0 to b7: 2nd octet 	00000001H to DFFFFFFEH	User
+6	Not used	—	—	—
+7	Number of resends	■Before instruction execution Specify the number of resends to be performed if the instruction is not completed within the monitoring time specified by (s1)+8. <ul style="list-style-type: none"> • 0 to 15 times ■At completion of instruction The number of resends performed (result) is stored. <ul style="list-style-type: none"> • 0 to 15 times*2 	0 to 15	User/system
+8	Arrival monitoring time	Specify the monitoring time until completion of processing. If processing is not completed within the monitoring time, the request is resent by the number of resends specified in (s1)+7. <ul style="list-style-type: none"> • 0: 10s • 1 to 32767: 1 to 32767s 	0 to 32767	User
+9	Read data length	Specify the number of words to be read.	1 to 240	User

Operand: (s1)				
Device	Item	Description	Setting range	Set by
+10 to +17	Not used	—	—	—

*1 A channel is used for the REMFR, REMTO, REMFRD, REMTOD, REMFRIP, REMTOIP, REMFRDIP, and REMTODIP instructions. The same channel number used for the link dedicated instructions (such as the READ instruction) can be set.

*2 If an error was detected, the number of resends performed (result) between error detection and resend stop is stored.

Processing details

- This instruction reads the data from the start address (s2) of the buffer memory area of the remote station to the word device ((d1) and later) of the own station for the specified number of words ((s1)+9). Specify the target station by using (U) and (s1)+3 to (s1)+5. The completion device (d2) turns on upon completion of the instruction.

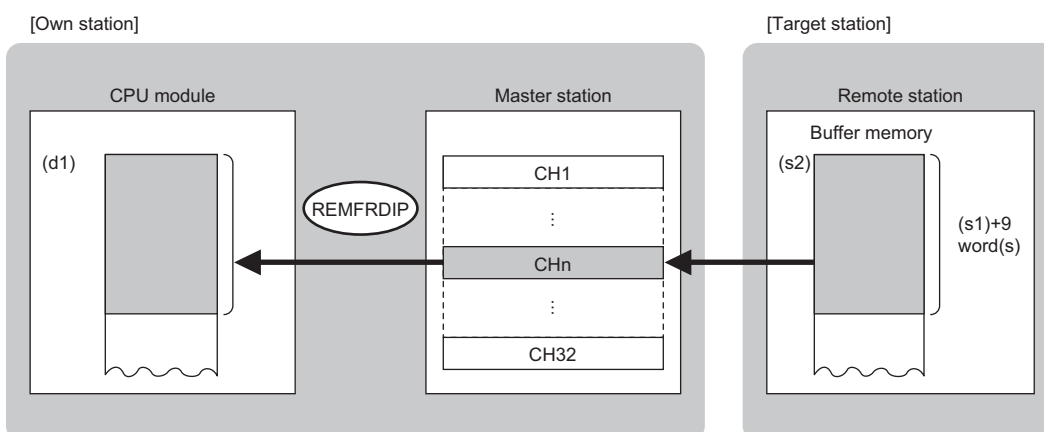

CH: Channel

- The execution status and the completion status of the REMFRDIP instruction can be checked with the completion device (d2) and the completion status indication device (d2)+1.

- Completion device (d2)

This device turns on during END processing of the scan where the REMFRDIP instruction completes, and turns off during the next END processing.

- Completion status indication device (d2)+1

This device turns on or off depending on the completion status of the REMFRDIP instruction.

When completed successfully: The device remains off.

When completed with an error: The device turns on during END processing of the scan where the REMFRDIP instruction completes, and turns off during the next END processing.

Precautions

For the REMFRDIP instruction, check the following before using the instruction.

- The REMFRDIP instruction can be used in the target station.
- The area can be accessed in the target station.

Operation error

Error code ((s1)+1)	Description
4000H to 4FFFH	Refer to the manual of the target station connected.
C000H to CFFFH D000H to DFFFH E000H to EFFFH	MELSEC iQ-R CC-Link IE TSN User's Manual (Application)

5.8 Writing Data to the Remote Station (Target Station IP Address Specified) (32-bit Address Specified)

GP.REMTODIP

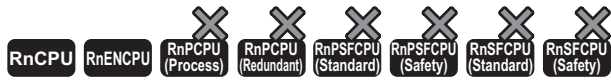

These instructions write data to the buffer memory area of the remote station. (in units of words, 32-bit address specified). The target station is also specified by the IP address.

Ladder	ST
	<pre>ENO:=GP_REMTODIP(EN,U,s1,s2,d1,d2);</pre>

FBD/LD

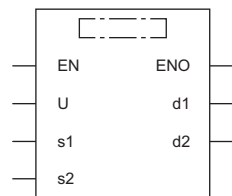

Execution condition

Instruction	Execution condition
GP.REMTODIP	

Setting data

Description, range, data type

Operand	Description	Range	Data type	Data type (label)
(U)	Start I/O number (first three digits in four-digit hexadecimal representation) of own station or own node	00H to FEH	16-bit unsigned binary	ANY16
(s1)	Own station start device where control data is stored	Page 242 Control data	Device name	ANY16 ^{*1}
(s2)	Start device of the own station, where the write-target data is stored	—	Device name	ANY16 ^{*1}
(d1)	Start address of the buffer memory area of the remote station where the data is written	00000000H to FFFFFFFFH (0 to 4294967295)	32-bit unsigned binary	ANY32
(d2)	Device of the own station, which turns on for one scan upon completion of the instruction. When the instruction completes with an error, (d2)+1 also turns on.	—	Bit	ANYBIT_ARRAY (Number of elements: 2)
EN	Execution condition	—	Bit	BOOL
ENO	Execution result	—	Bit	BOOL

*1 When specifying data with a label, define the array so that an area required for operation can be secured, and specify the array label element.

■Applicable devices

Operand	Bit		Word				Double word		Indirect specification	Constant			Others (U)
	X, Y, M, L, SM, F, B, SB, FX, FY	J□□	T, ST, C, D, W, SD, SW, FD, R, ZR, RD	U□V□, J□□, U3E□(H)G□	Z	LT, LST, LC	LZ	K, H, E, \$					
(U)	—	—	○	—	—	—	—	○	○	—	—	○	
(s1)	—	—	○*2	—	—	—	—	○	—	—	—	—	
(s2)	—	—	○*2	—	—	—	—	○	—	—	—	—	
(d1)	○*1	—	○*2	—	—	○	—	○	○	—	—	—	
(d2)	○*1	—	○*3	—	—	—	—	—	—	—	—	—	

*1 FX and FY cannot be used.

*2 FD cannot be used.

*3 T, ST, C, and FD cannot be used.

■Control data

Operand: (s1)				
Device	Item	Description	Setting range	Set by
+0	Execution/error completion type	b15 b14 ... b0 (1) <input type="text" value="0"/> (1) Target station address specification method (b15) • 0: Specify "network No." in (s1)+4, and "station number" in (s1)+5. • 1: Specify "IP address" in (s1)+4, 5	0000H 8000H	User
+1	Completion status	The instruction completion status is stored. • 0: Completed successfully • Other than 0: Completed with an error (error code)	—	System
+2	Own station channel ¹	Specify the channel of the own station which is used for the instruction.	1 to 32	User
+3	Start I/O number of target station	Specify the start I/O number of the target station.	0000H (fixed)	User
+4	Target network number	■When "0" is specified in bit 15 of (s1)+0 Specify the network number (1 to 239) of the target station. ■When "1" is specified in bit 15 of (s1)+0 Specify the IP address (third and fourth octets) of the target station. b15 ... b8 b7 ... b0 <input type="text"/> • b8 to b15: 3rd octet • b0 to b7: 4th octet	■(s1)+4 • Network number: 1 to 239 ■(s1)+5 • Station number: 1 to 120 ■(s1)+4, 5 • IP address: 00000001H to DFFFFFFEH	User
+5	Target station number	■When "0" is specified in bit 15 of (s1)+0 Specify the station number of the target station. • 1 to 120 ■When "1" is specified in bit 15 of (s1)+0 Specify the IP address (first and second octets) of the target station. b15 ... b8 b7 ... b0 <input type="text"/> • b8 to b15: 1st octet • b0 to b7: 2nd octet	00000001H to DFFFFFFEH	User
+6	Not used	—	—	—
+7	Number of resends	■Before instruction execution Specify the number of resends to be performed if the instruction is not completed within the monitoring time specified by (s1)+8. • 0 to 15 times ■At completion of instruction The number of resends performed (result) is stored. • 0 to 15 times ²	0 to 15	User/system
+8	Arrival monitoring time	Specify the monitoring time until completion of processing. If processing is not completed within the monitoring time, the request is resent by the number of resends specified in (s1)+7. • 0: 10s • 1 to 32767: 1 to 32767s	0 to 32767	User
+9	Write data length	Specify the number of words to be written.	1 to 240	User

Operand: (s1)				
Device	Item	Description	Setting range	Set by
+10 to +17	Not used	—	—	—

*1 A channel is used for the REMFR, REMTO, REMFRD, REMTOD, REMFRIP, REMTOIP, REMFRDIP, and REMTODIP instructions. The same channel number used for the link dedicated instructions (such as the READ instruction) can be set.

*2 If an error was detected, the number of resends performed (result) between error detection and resend stop is stored.

Processing details

- These instructions write the data from the start device (s2) of the own station to the buffer memory areas ((d1) and later) of the remote station for the specified number of words ((s1)+9). Specify the target station by using (U) and (s1)+3 to (s1)+5. The completion device (d2) turns on upon completion of the instruction.

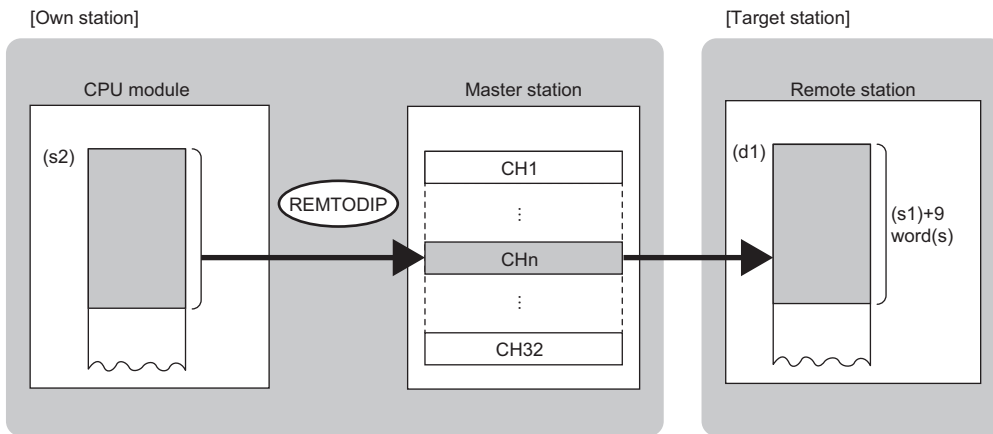

CH: Channel

- The execution status and the completion status of the REMTODIP instruction can be checked with the completion device (d2) and the completion status indication device (d2)+1.

- Completion device (d2)

This device turns on during END processing of the scan where the REMTODIP instruction completes, and turns off during the next END processing.

- Completion status indication device (d2)+1

This device turns on or off depending on the completion status of the REMTODIP instruction.

When completed successfully: The device remains off.

When completed with an error: The device turns on during END processing of the scan where the REMTODIP instruction completes, and turns off during the next END processing.

Precautions

For the REMTODIP instruction, check the following before using the instruction.

- The REMTODIP instruction can be used in the target station.
- The area can be accessed in the target station.

Operation error

Error code ((s1)+1)	Description
4000H to 4FFFH	Refer to the manual of the target station connected.
C000H to CFFFH D000H to DFFFH E000H to EFFFH	MELSEC iQ-R CC-Link IE TSN User's Manual (Application)

5.9 Setting Parameters

G(P).CCPASETX



Set parameters to the RJ71GN11-T2.

Ladder	ST
	<pre>ENO:=G_CCPASETX(EN,U,s1,s2,s3,s4,s5,d); ENO:=GP_CCPASETX(EN,U,s1,s2,s3,s4,s5,d);</pre>

FBD/LD

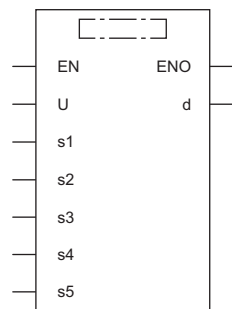

Execution condition

Instruction	Execution condition
G.CCPASETX	
GP.CCPASETX	

Setting data

Description, range, data type

Operand	Description	Range	Data type	Data type (label)
(U)	Start I/O number (first three digits in four-digit hexadecimal representation) of own station or own node	00H to FEH	16-bit unsigned binary	ANY16
(s1)	Own station start device where control data is stored	Page 245 Control data	Device name	ANY16 ^{*1}
(s2)	Own station start device where the network configuration setting is stored	Page 247 Network configuration setting data (for master station setting only)	Device name	ANY16 ^{*1}
(s3)	Own station start device where the reserved station specification is stored	Page 248 Reserved station setting data (for master station setting only)	Device name	ANY16 ^{*1}
(s4)	Own station start device where the error invalid station settings is stored	Page 249 Error invalid station setting data (for master station setting only)	Device name	ANY16 ^{*1}
(s5)	Own station start device where the communication cycle data is stored	Page 250 Communication cycle setting data (for master station setting only)	Device name	ANY16 ^{*1}
(d)	Device of the own station, which turns on for one scan upon completion of the instruction. When the instruction completes with an error, (d)+1 also turns on.	—	Bit	ANYBIT_ARRAY (Number of elements: 2)
EN	Execution condition	—	Bit	BOOL
ENO	Execution result	—	Bit	BOOL

*1 When specifying data with a label, define the array so that an area required for operation can be secured, and specify the array label element.

■Applicable devices

Operand	Bit		Word			Double word		Indirect specification	Constant			Others (U)
	X, Y, M, L, SM, F, B, SB, FX, FY	J□□	T, ST, C, D, W, SD, SW, FD, R, ZR, RD	U□\G□, J□\□, U3E□\□(H)G□	Z	LT, LST, LC	LZ		K, H	E	\$	
(U)	—	—	○	—	—	—	○	○	—	—	○	
(s1)	—	—	○*2	—	—	—	○	—	—	—	—	
(s2)	—	—	○*2	—	—	—	○	—	—	—	—	
(s3)	—	—	○*2	—	—	—	○	—	—	—	—	
(s4)	—	—	○*2	—	—	—	○	—	—	—	—	
(s5)	—	—	○*2	—	—	—	○	—	—	—	—	
(d)	○*1	—	○*3	—	—	—	—	—	—	—	—	

*1 FX and FY cannot be used.

*2 FD cannot be used.

*3 T, ST, C, and FD cannot be used.

■Control data

Operand: (s1)				
Device	Item	Description	Setting range*1	Set by
+0	Completion status	The instruction completion status is stored. • 0: Normal • Other than 0: Error (error code)	—	System
+1	Setting flag	Specify whether the setting data in (s2) to (s4) are valid/invalid. b15b14b13b12b11b10 b9 b8 b7 b6 b5 b4 b3 b2 b1 b0 (9) 0 (8) (7) 0 (6) (5) 0 (4) 0 (3) (2) (1)	Left	User
+2	Total number of stations	Specify the total number of slave stations connected.	2 to 121	User
+3	Disconnection detection setting	Specify the continuous communications failure count before the slave station is detected to be disconnected. • 1: 2 times • 2: 4 times • 3: 8 times	1 to 3	User
+4	Communication mode	Set communication mode. • 0: Unicast • 1: Multicast*3	0, 1	User

*1 If a value outside the setting range is set, the instruction will complete with an error.

*2 If "Invalid" is set, the default parameter will be used.

*3 Firmware version "04" or later supports the settings.

Point 

For the startup in the local station, only Data link faulty station setting (bit 8 of (s1)+1), Output setting for CPU STOP (bit 9 of (s1)+1), and Communication speed setting (bit 11 of (s1)+1) will be valid. Any other changed settings will be ignored during execution of the instruction, without causing an error.

■ Network configuration setting data (for master station setting only)

Operand: (s2)																											
Device	Item	Description	Setting range ^{*1}	Set by																							
+0	For 1st module (Master station)	Station setting information	Specify the station number, the number of occupied stations, and the station type for each slave station.	F100H (fixed)	User																						
+1 to +6		Not used	—	—	—																						
+7 +8		LB offset	Specify the offset value from the head of LB (in units of 16 points). ^{*2}	0 to 32752	User																						
+9 +10		Number of LB points	Specify the number of LB points in units of 16 points (in units of 16 points). ^{*2}	0 to 32768	User																						
+11 +12		LW offset	Specify the offset value from the head of LW. ^{*2}	0 to 16383	User																						
+13 +14		Number of LW points	Specify the number of LW points. ^{*2}	0 to 16384	User																						
+15		For 2nd module (Slave station)	Station setting information	Specify the station number, the number of occupied stations, and the station type for each slave station. <table border="1" style="margin-left: 20px;"> <tr> <td>b15</td><td>...</td><td>b13</td><td>b12</td><td>b11</td><td>...</td><td>b9</td><td>b8</td><td>b7</td><td>...</td><td>b0</td> </tr> <tr> <td>0</td><td></td><td>(3)</td><td></td><td>0</td><td></td><td>(2)</td><td></td><td></td><td></td><td>(1)</td> </tr> </table> <ul style="list-style-type: none"> (1) Station number <ul style="list-style-type: none"> • 1 to 120 (2) Number of occupied stations <ul style="list-style-type: none"> • 1 (fixed) (3) Station type <ul style="list-style-type: none"> • 0: Remote station • 1: Local station 	b15	...	b13	b12	b11	...	b9	b8	b7	...	b0	0		(3)		0		(2)				(1)	Left
b15	...		b13	b12	b11	...	b9	b8	b7	...	b0																
0			(3)		0		(2)				(1)																
+16 +17	RX/Ry offset		Specify the offset value from the head of RX/Ry (in units of 16 points). ^{*2}	0 to 16368	User																						
+18	Number of RX/Ry points		Specify the number of RX/Ry points (in units of 16 points). ^{*2}	0 to 16384	User																						
+19 +20	RWr/RWw offset		Specify the offset value from the start of RWr/RWw (in units of 4 points). ^{*2}	0 to 8188	User																						
+21	Number of RWr/RWw points		Specify the number of RWr/RWw points (in units of 4 points). ^{*2}	0 to 8192	User																						
+22 +23	LB offset		Specify the offset value from the head of LB (in units of 16 points). ^{*2}	0 to 32752	User																						
+24 +25	Number of LB points		Specify the number of LB points in units of 16 points (in units of 16 points). ^{*2}	0 to 32768	User																						
+26 +27	LW offset		Specify the offset value from the head of LW. ^{*2}	0 to 16383	User																						
+28 +29	Number of LW points		Specify the number of LW points. ^{*2}	0 to 16384	User																						
+30	IP address		Specify the IP address (third and fourth octets) of the target station. <table border="1" style="margin-left: 20px;"> <tr> <td>b15</td><td>...</td><td>b8</td><td>b7</td><td>...</td><td>b0</td> </tr> <tr> <td colspan="3"></td><td colspan="3"></td> </tr> </table> <ul style="list-style-type: none"> • b8 to b15: 3rd octet • b0 to b7: 4th octet 	b15	...	b8	b7	...	b0							0000001H to DFFFFFFEH	User										
b15			...	b8	b7	...	b0																				
+31	Specify the IP address (first and second octets) of the target station. <table border="1" style="margin-left: 20px;"> <tr> <td>b15</td><td>...</td><td>b8</td><td>b7</td><td>...</td><td>b0</td> </tr> <tr> <td colspan="3"></td><td colspan="3"></td> </tr> </table> <ul style="list-style-type: none"> • b8 to b15: 1st octet • b0 to b7: 2nd octet 	b15	...	b8	b7	...	b0							User													
b15	...	b8	b7	...	b0																						
+32	Communication cycle setting	Specify the communication cycle. <ul style="list-style-type: none"> • 0: Standard cycle • 1: Medium speed • 2: Low speed 	0 to 2	User																							

Operand: (s2)				
Device	Item	Description	Setting range*1	Set by
+33 to +2174	For 3rd to 121st module (Slave station)	It is the same as the description for the second module ((s2)+15 to (s2)+32).		User

*1 If a value outside the setting range is set for the appropriate station information setting, the instruction will complete with an error.

*2 The specified number of points is regarded as the number of RX/Ry, RWr/RWw, or LB/LW points.
Set parameters for the total number of stations that was set in the control data.



If the specified total number of stations does not match the individual station setting data, the total number of individual stations specified in the total number of stations take precedence. Individual station information which is specified exceeding the total number of stations is ignored.

For instance, when station information are set for 10 modules even though the specified total number of stations is two, the set station information become valid for the 1st and 2nd modules only, and parameters written to the 3rd to 10th modules are ignored.

Reserved station setting data (for master station setting only)

Operand: (s3)																																																																																																																																																																																																																																																																																																					
Device	Item	Description	Setting range	Set by																																																																																																																																																																																																																																																																																																	
+0 to +15	Station 1 to 120 specification*1	Specify the reserved station. • 0: Not specified • 1: Specified Each number in the table indicates a station number. <table border="1" style="margin-left: 40px;"> <thead> <tr> <th></th> <th>b15</th><th>b14</th><th>b13</th><th>b12</th><th>b11</th><th>b10</th><th>b9</th><th>b8</th><th>b7</th><th>b6</th><th>b5</th><th>b4</th><th>b3</th><th>b2</th><th>b1</th><th>b0</th> </tr> </thead> <tbody> <tr> <td>(s3)+0</td> <td>16</td><td>15</td><td>14</td><td>13</td><td>12</td><td>11</td><td>10</td><td>9</td><td>8</td><td>7</td><td>6</td><td>5</td><td>4</td><td>3</td><td>2</td><td>1</td> </tr> <tr> <td>(s3)+1</td> <td>32</td><td>31</td><td>30</td><td>29</td><td>28</td><td>27</td><td>26</td><td>25</td><td>24</td><td>23</td><td>22</td><td>21</td><td>20</td><td>19</td><td>18</td><td>17</td> </tr> <tr> <td>(s3)+2</td> <td>48</td><td>47</td><td>46</td><td>45</td><td>44</td><td>43</td><td>42</td><td>41</td><td>40</td><td>39</td><td>38</td><td>37</td><td>36</td><td>35</td><td>34</td><td>33</td> </tr> <tr> <td>(s3)+3</td> <td>64</td><td>63</td><td>62</td><td>61</td><td>60</td><td>59</td><td>58</td><td>57</td><td>56</td><td>55</td><td>54</td><td>53</td><td>52</td><td>51</td><td>50</td><td>49</td> </tr> <tr> <td>(s3)+4</td> <td>80</td><td>79</td><td>78</td><td>77</td><td>76</td><td>75</td><td>74</td><td>73</td><td>72</td><td>71</td><td>70</td><td>69</td><td>68</td><td>67</td><td>66</td><td>65</td> </tr> <tr> <td>(s3)+5</td> <td>96</td><td>95</td><td>94</td><td>93</td><td>92</td><td>91</td><td>90</td><td>89</td><td>88</td><td>87</td><td>86</td><td>85</td><td>84</td><td>83</td><td>82</td><td>81</td> </tr> <tr> <td>(s3)+6</td> <td>112</td><td>111</td><td>110</td><td>109</td><td>108</td><td>107</td><td>106</td><td>105</td><td>104</td><td>103</td><td>102</td><td>101</td><td>100</td><td>99</td><td>98</td><td>97</td> </tr> <tr> <td>(s3)+7</td> <td colspan="8" style="text-align: center;">-</td> <td>120</td><td>119</td><td>118</td><td>117</td><td>116</td><td>115</td><td>114</td><td>113</td> </tr> <tr> <td>(s3)+8</td> <td colspan="16" style="text-align: center;">-</td> </tr> <tr> <td>(s3)+9</td> <td colspan="16" style="text-align: center;">-</td> </tr> <tr> <td>(s3)+10</td> <td colspan="16" style="text-align: center;">-</td> </tr> <tr> <td>(s3)+11</td> <td colspan="16" style="text-align: center;">-</td> </tr> <tr> <td>(s3)+12</td> <td colspan="16" style="text-align: center;">-</td> </tr> <tr> <td>(s3)+13</td> <td colspan="16" style="text-align: center;">-</td> </tr> <tr> <td>(s3)+14</td> <td colspan="16" style="text-align: center;">-</td> </tr> <tr> <td>(s3)+15</td> <td colspan="16" style="text-align: center;">-</td> </tr> </tbody> </table> The default parameter specifies that all stations are 0 (not specified). The master station cannot be specified as a reserved station.		b15	b14	b13	b12	b11	b10	b9	b8	b7	b6	b5	b4	b3	b2	b1	b0	(s3)+0	16	15	14	13	12	11	10	9	8	7	6	5	4	3	2	1	(s3)+1	32	31	30	29	28	27	26	25	24	23	22	21	20	19	18	17	(s3)+2	48	47	46	45	44	43	42	41	40	39	38	37	36	35	34	33	(s3)+3	64	63	62	61	60	59	58	57	56	55	54	53	52	51	50	49	(s3)+4	80	79	78	77	76	75	74	73	72	71	70	69	68	67	66	65	(s3)+5	96	95	94	93	92	91	90	89	88	87	86	85	84	83	82	81	(s3)+6	112	111	110	109	108	107	106	105	104	103	102	101	100	99	98	97	(s3)+7	-								120	119	118	117	116	115	114	113	(s3)+8	-																(s3)+9	-																(s3)+10	-																(s3)+11	-																(s3)+12	-																(s3)+13	-																(s3)+14	-																(s3)+15	-																Left	User
	b15	b14	b13	b12	b11	b10	b9	b8	b7	b6	b5	b4	b3	b2	b1	b0																																																																																																																																																																																																																																																																																					
(s3)+0	16	15	14	13	12	11	10	9	8	7	6	5	4	3	2	1																																																																																																																																																																																																																																																																																					
(s3)+1	32	31	30	29	28	27	26	25	24	23	22	21	20	19	18	17																																																																																																																																																																																																																																																																																					
(s3)+2	48	47	46	45	44	43	42	41	40	39	38	37	36	35	34	33																																																																																																																																																																																																																																																																																					
(s3)+3	64	63	62	61	60	59	58	57	56	55	54	53	52	51	50	49																																																																																																																																																																																																																																																																																					
(s3)+4	80	79	78	77	76	75	74	73	72	71	70	69	68	67	66	65																																																																																																																																																																																																																																																																																					
(s3)+5	96	95	94	93	92	91	90	89	88	87	86	85	84	83	82	81																																																																																																																																																																																																																																																																																					
(s3)+6	112	111	110	109	108	107	106	105	104	103	102	101	100	99	98	97																																																																																																																																																																																																																																																																																					
(s3)+7	-								120	119	118	117	116	115	114	113																																																																																																																																																																																																																																																																																					
(s3)+8	-																																																																																																																																																																																																																																																																																																				
(s3)+9	-																																																																																																																																																																																																																																																																																																				
(s3)+10	-																																																																																																																																																																																																																																																																																																				
(s3)+11	-																																																																																																																																																																																																																																																																																																				
(s3)+12	-																																																																																																																																																																																																																																																																																																				
(s3)+13	-																																																																																																																																																																																																																																																																																																				
(s3)+14	-																																																																																																																																																																																																																																																																																																				
(s3)+15	-																																																																																																																																																																																																																																																																																																				

*1 Make the setting for the station number that was set with the appropriate setting information setting data.

■Error invalid station setting data (for master station setting only)

Operand: (s4)																																																																																																																																																																																																																																																																																																					
Device	Item	Description	Setting range	Set by																																																																																																																																																																																																																																																																																																	
+0 to +15	Station 1 to 120 specification *1	Specify the error invalid station. • 0: Not specified • 1: Specified Each number in the table indicates a station number. <table border="1" style="margin-left: 40px;"> <thead> <tr> <th></th> <th>b15</th><th>b14</th><th>b13</th><th>b12</th><th>b11</th><th>b10</th><th>b9</th><th>b8</th><th>b7</th><th>b6</th><th>b5</th><th>b4</th><th>b3</th><th>b2</th><th>b1</th><th>b0</th> </tr> </thead> <tbody> <tr> <td>(s4)+0</td> <td>16</td><td>15</td><td>14</td><td>13</td><td>12</td><td>11</td><td>10</td><td>9</td><td>8</td><td>7</td><td>6</td><td>5</td><td>4</td><td>3</td><td>2</td><td>1</td> </tr> <tr> <td>(s4)+1</td> <td>32</td><td>31</td><td>30</td><td>29</td><td>28</td><td>27</td><td>26</td><td>25</td><td>24</td><td>23</td><td>22</td><td>21</td><td>20</td><td>19</td><td>18</td><td>17</td> </tr> <tr> <td>(s4)+2</td> <td>48</td><td>47</td><td>46</td><td>45</td><td>44</td><td>43</td><td>42</td><td>41</td><td>40</td><td>39</td><td>38</td><td>37</td><td>36</td><td>35</td><td>34</td><td>33</td> </tr> <tr> <td>(s4)+3</td> <td>64</td><td>63</td><td>62</td><td>61</td><td>60</td><td>59</td><td>58</td><td>57</td><td>56</td><td>55</td><td>54</td><td>53</td><td>52</td><td>51</td><td>50</td><td>49</td> </tr> <tr> <td>(s4)+4</td> <td>80</td><td>79</td><td>78</td><td>77</td><td>76</td><td>75</td><td>74</td><td>73</td><td>72</td><td>71</td><td>70</td><td>69</td><td>68</td><td>67</td><td>66</td><td>65</td> </tr> <tr> <td>(s4)+5</td> <td>96</td><td>95</td><td>94</td><td>93</td><td>92</td><td>91</td><td>90</td><td>89</td><td>88</td><td>87</td><td>86</td><td>85</td><td>84</td><td>83</td><td>82</td><td>81</td> </tr> <tr> <td>(s4)+6</td> <td>112</td><td>111</td><td>110</td><td>109</td><td>108</td><td>107</td><td>106</td><td>105</td><td>104</td><td>103</td><td>102</td><td>101</td><td>100</td><td>99</td><td>98</td><td>97</td> </tr> <tr> <td>(s4)+7</td> <td colspan="8" style="text-align: center;">-</td> <td>120</td><td>119</td><td>118</td><td>117</td><td>116</td><td>115</td><td>114</td><td>113</td> </tr> <tr> <td>(s4)+8</td> <td colspan="16" style="text-align: center;">-</td> </tr> <tr> <td>(s4)+9</td> <td colspan="16" style="text-align: center;">-</td> </tr> <tr> <td>(s4)+10</td> <td colspan="16" style="text-align: center;">-</td> </tr> <tr> <td>(s4)+11</td> <td colspan="16" style="text-align: center;">-</td> </tr> <tr> <td>(s4)+12</td> <td colspan="16" style="text-align: center;">-</td> </tr> <tr> <td>(s4)+13</td> <td colspan="16" style="text-align: center;">-</td> </tr> <tr> <td>(s4)+14</td> <td colspan="16" style="text-align: center;">-</td> </tr> <tr> <td>(s4)+15</td> <td colspan="16" style="text-align: center;">-</td> </tr> </tbody> </table> The default parameter specifies that all stations are 0 (not specified). The master station cannot be specified as a reserved station.		b15	b14	b13	b12	b11	b10	b9	b8	b7	b6	b5	b4	b3	b2	b1	b0	(s4)+0	16	15	14	13	12	11	10	9	8	7	6	5	4	3	2	1	(s4)+1	32	31	30	29	28	27	26	25	24	23	22	21	20	19	18	17	(s4)+2	48	47	46	45	44	43	42	41	40	39	38	37	36	35	34	33	(s4)+3	64	63	62	61	60	59	58	57	56	55	54	53	52	51	50	49	(s4)+4	80	79	78	77	76	75	74	73	72	71	70	69	68	67	66	65	(s4)+5	96	95	94	93	92	91	90	89	88	87	86	85	84	83	82	81	(s4)+6	112	111	110	109	108	107	106	105	104	103	102	101	100	99	98	97	(s4)+7	-								120	119	118	117	116	115	114	113	(s4)+8	-																(s4)+9	-																(s4)+10	-																(s4)+11	-																(s4)+12	-																(s4)+13	-																(s4)+14	-																(s4)+15	-																Left	User
	b15	b14	b13	b12	b11	b10	b9	b8	b7	b6	b5	b4	b3	b2	b1	b0																																																																																																																																																																																																																																																																																					
(s4)+0	16	15	14	13	12	11	10	9	8	7	6	5	4	3	2	1																																																																																																																																																																																																																																																																																					
(s4)+1	32	31	30	29	28	27	26	25	24	23	22	21	20	19	18	17																																																																																																																																																																																																																																																																																					
(s4)+2	48	47	46	45	44	43	42	41	40	39	38	37	36	35	34	33																																																																																																																																																																																																																																																																																					
(s4)+3	64	63	62	61	60	59	58	57	56	55	54	53	52	51	50	49																																																																																																																																																																																																																																																																																					
(s4)+4	80	79	78	77	76	75	74	73	72	71	70	69	68	67	66	65																																																																																																																																																																																																																																																																																					
(s4)+5	96	95	94	93	92	91	90	89	88	87	86	85	84	83	82	81																																																																																																																																																																																																																																																																																					
(s4)+6	112	111	110	109	108	107	106	105	104	103	102	101	100	99	98	97																																																																																																																																																																																																																																																																																					
(s4)+7	-								120	119	118	117	116	115	114	113																																																																																																																																																																																																																																																																																					
(s4)+8	-																																																																																																																																																																																																																																																																																																				
(s4)+9	-																																																																																																																																																																																																																																																																																																				
(s4)+10	-																																																																																																																																																																																																																																																																																																				
(s4)+11	-																																																																																																																																																																																																																																																																																																				
(s4)+12	-																																																																																																																																																																																																																																																																																																				
(s4)+13	-																																																																																																																																																																																																																																																																																																				
(s4)+14	-																																																																																																																																																																																																																																																																																																				
(s4)+15	-																																																																																																																																																																																																																																																																																																				

*1 Make the setting for the station number that was set with the appropriate setting information setting data.
 If both the error invalid and reserved stations are specified for the same station, the reserved station setting will take priority.

Point

Any station numbers outside the range specified by the total number of stations or other than those specified in the individual station information settings are ignored even if they are specified as reserved stations or temporary error invalid stations.

For instance, assume that station No.3 and station No.4 are specified as reserved stations with items set as follows: total number of stations = 2, information for 1st module = station No.1, information for 2nd module = station No.2, information for 3rd module = station No.3, information for 4th module = station No.4. Since parameters become valid for information of the 1st and 2nd modules only, the reserved station settings for station No.3 and station No.4 are ignored. (In this case, when the total number of stations is changed to 4, the reserved station settings for station No.3 and station No.4 become valid.)

■Communication cycle setting data (for master station setting only)

Operand: (s5)				
Device	Item	Description	Setting range	Set by
+0	Setting in units of 1 μ s	Specify "Set" or "Not set" in units of 1 μ s to the communication cycle interval. <ul style="list-style-type: none"> • 0: Not set • 1: Set 	0, 1	User
+1 +2	Communication cycle interval setting	Specify the communication cycle interval. ■When "0" is specified in (s5)+0 [Specification method] Set any of the following values in (s5)+1. (The value set in (s5)+2 is ignored.) <ul style="list-style-type: none"> • 2: 125.00μs • 3: 250.00μs • 4: 500.00μs • 5: 1000.00μs • 6: 2000.00μs • 7: 4000.00μs • 8: 8000.00μs^{*1} [Setting range] 2 to 8 [Setting example] To set 250.00 μ s: (s5)+1 \rightarrow 3, (s5)+2 \rightarrow 0 ■When "1" is specified in (s5)+0 [Specification method] <ul style="list-style-type: none"> • (s5)+1: Value in units of ms • (s5)+2: Value in units of μs [Setting range] 125.00 μ s to 10000.00 μ s ^{*2} [Setting example] To set 162.00 μ s: (s5)+1 \rightarrow 0, (s5)+2 \rightarrow 162	Left	User
+3	Not used	—	—	—
+4	System reservation time	Set the system reservation time. <ul style="list-style-type: none"> • 0: 20.00μs • 1: 200.00μs 	0, 1	User
+5 +6	Cyclic transmission time	Specify the cyclic transmission time of the CC-Link IE TSN. ■Specification method <ul style="list-style-type: none"> • (s5)+5: Value in units of ms • (s5)+6: Value in units of μs ■Setting range 5 μ s to 9966.00 μ s ^{*3} ■Example: When the value is 38μs (0ms, 38μs) <ul style="list-style-type: none"> • (s5)+5: 0 • (s5)+6: 38 	Left	User
+7 +8	Not used	—	—	—
+9	Medium speed	Specify the medium speed to the communication cycle interval specified in (s5)+1 to (s5)+3. (Unit: Double)	4 (fixed)	User
+10	Low speed	Specify the low speed to the communication cycle interval specified in (s5)+1 to (s5)+3. (Unit: Double)	16 (fixed)	User

*1 Firmware version "04" or later supports the settings.

*2 The setting range of firmware version "03" or earlier is 125.00 μ s to 4000.00 μ s.

*3 The setting range of firmware version "03" or earlier is 5 μ s to 3966.00 μ s.

Processing details

- Set parameters to the RJ71GN11-T2.

[Own station]

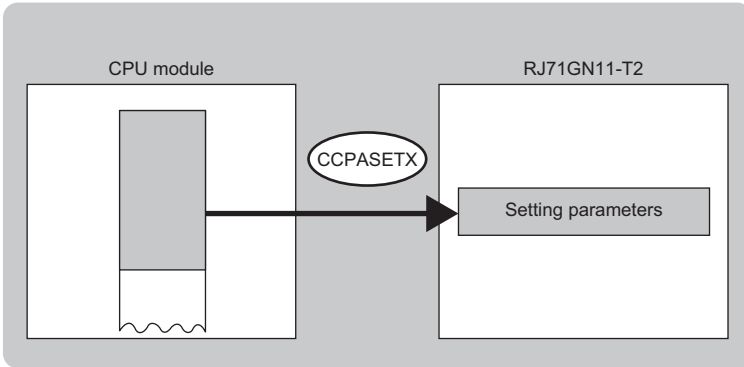

- The execution status and the completion status of the G(P).CCPASETX instruction can be checked with the completion device (d) and the completion status indication device (d)+1.

- Completion device (d)

This device turns on during END processing of the scan where the G(P).CCPASETX instruction completes, and turns off during the next END processing.

- Completion status indication device (d)+1

This device turns on or off depending on the completion status of the G(P).CCPASETX instruction.

When completed successfully: The device remains off.

When completed with an error: The device turns on during END processing of the scan where the G(P).CCPASETX instruction completes, and turns off during the next END processing.

Precautions

- The G(P).CCPASETX instruction can be executed only one time after power-on. If this instruction is executed two times or more, an error (error code: DA1AH) is detected.
- Before executing the G(P).CCPASETX instruction, execute the UINI instruction or module FB (M+RJ71GN11_SetAddress) and specify the station number and IP address. (Execute the above regardless of the setting value of the "Station Number/ IP Address Setting" that is set from the module parameter of the engineering tool.)
- Values set for the master station must be consistent with values set for the slave stations in the network configuration setting data (s2). If they are not consistent, an error (error code: 2221H) is detected.

Operation error

Error code ((s1)+0)	Description
C000H to CFFFH D000H to DFFFH E000H to EFFFH	MELSEC iQ-R CC-Link IE TSN User's Manual (Application)

5.10 Setting Parameters

G(P).CCPASET

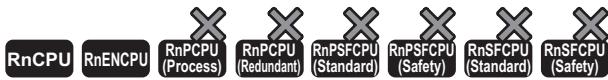

Set parameters to the RJ71GN11-T2. (For CC-Link IE Field Network instruction compatibility)

Ladder	ST
	<pre>ENO:=G_CCPASET(EN,U,s1,s2,s3,s4,d); ENO:=GP_CCPASET(EN,U,s1,s2,s3,s4,d);</pre>

FBD/LD

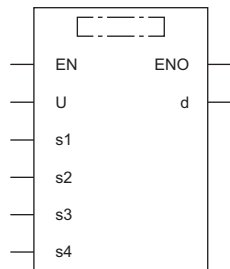

Execution condition

Instruction	Execution condition
G.CCPASET	
GP.CCPASET	

Setting data

Description, range, data type

Operand	Description	Range	Data type	Data type (label)
(U)	Start I/O number (first three digits in four-digit hexadecimal representation) of own station or own node	00H to FEH	16-bit unsigned binary	ANY16
(s1)	Own station start device where control data is stored	Page 253 Control data	Device name	ANY16*1
(s2)	Own station start device where the network configuration setting is stored	Page 254 Network configuration setting data (for master station setting only)	Device name	ANY16*1
(s3)	Own station start device where the reserved station specification is stored	Page 255 Reserved station setting data (for master station setting only)	Device name	ANY16*1
(s4)	Own station start device where the error invalid station settings are stored	Page 255 Error invalid station setting data (for master station setting only)	Device name	ANY16*1
(d)	Device of the own station, which turns on for one scan upon completion of the instruction. When the instruction completes with an error, (d)+1 also turns on.	—	Bit	ANYBIT_ARRAY (Number of elements: 2)
EN	Execution condition	—	Bit	BOOL
ENO	Execution result	—	Bit	BOOL

*1 When specifying data with a label, define the array so that an area required for operation can be secured, and specify the array label element.

■Applicable devices

Operand	Bit		Word			Double word		Indirect specification	Constant			Others (U)
	X, Y, M, L, SM, F, B, SB, FX, FY	J□□	T, ST, C, D, W, SD, SW, FD, R, ZR, RD	U□\G□, J□\□, U3E□\□(H)G□	Z	LT, LST, LC	LZ		K, H	E	\$	
(U)	—	—	○	—	—	—	—	○	○	—	—	○
(s1)	—	—	○*2	—	—	—	—	○	—	—	—	—
(s2)	—	—	○*2	—	—	—	—	○	—	—	—	—
(s3)	—	—	○*2	—	—	—	—	○	—	—	—	—
(s4)	—	—	○*2	—	—	—	—	○	—	—	—	—
(d)	○*1	—	○*3	—	—	—	—	—	—	—	—	—

*1 FX and FY cannot be used.

*2 FD cannot be used.

*3 T, ST, C, and FD cannot be used.

■Control data

Operand: (s1)													
Device	Item	Description	Setting range*1	Set by									
+0	Completion status	The instruction completion status is stored. • 0: Normal • Other than 0: Error (error code)	—	System									
+1	Setting flag	Specify whether the setting data in (s2) to (s4) are valid/invalid. b15 b14 b13 b12 b11 b10 b9 b8 b7 b6 b5 b4 b3 b2 b1 b0 <table border="1" style="margin-left: 20px;"> <tr> <td>0</td> <td>(6)</td> <td>0</td> <td>(5)</td> <td>(4)</td> <td>0</td> <td>(3)</td> <td>(2)</td> <td>(1)</td> </tr> </table> (1) Presence of network configuration setting data (bit 0) • 0: Invalid*2 • 1: Valid (2) Presence of reserved station setting data (bit 1) • 0: Invalid*2 • 1: Valid (3) Presence of error invalid station setting data (bit 2) • 0: Invalid*2 • 1: Valid (4) Data link faulty station setting (bit 8) • 0: Cleared • 1: Held (5) Output setting for CPU STOP (bit 9) • 0: Held • 1: Cleared (6) Output setting for CPU error (bit 12) • 0: Cleared • 1: Held	0	(6)	0	(5)	(4)	0	(3)	(2)	(1)	Left	User
0	(6)	0	(5)	(4)	0	(3)	(2)	(1)					
+2	Total number of slave stations	Specify the total number of slave stations connected.	1 to 120	User									
+3 to +5	Not used	—	—	—									

*1 If a value outside the setting range is set, the instruction will complete with an error.

*2 If "Invalid" is set, the default parameter will be used.

For the startup in the local station, only Data link faulty station setting (bit 8 of (s1)+1) and Output setting for CPU STOP (bit 9 of (s1)+1) will be valid. Any other changed settings will be ignored during execution of the instruction, without causing an error.

Network configuration setting data (for master station setting only)

Operand: (s2)							
Device	Item	Description	Setting range ^{*1}	Set by			
+0	For 1st module	Slave station setting information Specify the station type, the number of occupied stations, and the station number. b15 ... b12 b11 ... b8 b7 ... b0 <table border="1" style="margin-left: 20px; width: 100%;"> <tr> <td style="width: 33%; text-align: center;">(3)</td> <td style="width: 33%; text-align: center;">(2)</td> <td style="width: 33%; text-align: center;">(1)</td> </tr> </table> (1) Station number • 1 to 120: Station number (2) Number of occupied stations • 1: Fixed (3) Station type • 0 to 2: Remote station • 3: Local station	(3)	(2)	(1)	Left	User
(3)	(2)	(1)					
+1		RX/RX offset	Specify the offset value from the head of RX/RX (in units of 16 points). ^{*2}	0 to 16368	User		
+2		Number of RX/RX points	Specify the number of RX/RX points (in units of 16 points). ^{*2}	0 to 16384	User		
+3		RWw/RWw offset	Specify the offset value from the start of RWw/RWw (in units of 4 points). ^{*2}	0 to 8188	User		
+4		Number of RWw/RWw points	Specify the number of RWw/RWw points (in units of 4 points). ^{*2}	0 to 8192	User		
+5 to +599	For 2nd to 120th module	Same as above			User		

*1 If a value outside the setting range is set for the appropriate station information setting, the instruction will complete with an error.
*2 The specified number of points is regarded as the number of RX/RX or RWw/RWw points.
Set parameters for the total number of slave stations that was set in the control data.

If the specified total number of slave stations does not match the individual station setting data, the total number of individual stations specified in the total number of slave stations take precedence. Individual station information which is specified exceeding the total number of slave stations is ignored.
For instance, when station information are set for 10 modules even though the specified total number of slave stations is two, the set station information become valid for the 1st and 2nd modules only, and parameters written to 3rd to 10th modules are ignored.

Reserved station setting data (for master station setting only)

Operand: (s3)																																																																																																																																																													
Device	Item	Description	Setting range	Set by																																																																																																																																																									
+0 to +7	Station 1 to 120 specification ^{*1}	Specify the reserved station. • 0: Not specified • 1: Specified Each number in the table indicates a station number. <table border="1" style="margin-left: 40px;"> <thead> <tr> <th></th> <th>b15</th><th>b14</th><th>b13</th><th>b12</th><th>b11</th><th>b10</th><th>b9</th><th>b8</th><th>b7</th><th>b6</th><th>b5</th><th>b4</th><th>b3</th><th>b2</th><th>b1</th><th>b0</th> </tr> </thead> <tbody> <tr> <td>(s3)+0</td> <td>16</td><td>15</td><td>14</td><td>13</td><td>12</td><td>11</td><td>10</td><td>9</td><td>8</td><td>7</td><td>6</td><td>5</td><td>4</td><td>3</td><td>2</td><td>1</td> </tr> <tr> <td>(s3)+1</td> <td>32</td><td>31</td><td>30</td><td>29</td><td>28</td><td>27</td><td>26</td><td>25</td><td>24</td><td>23</td><td>22</td><td>21</td><td>20</td><td>19</td><td>18</td><td>17</td> </tr> <tr> <td>(s3)+2</td> <td>48</td><td>47</td><td>46</td><td>45</td><td>44</td><td>43</td><td>42</td><td>41</td><td>40</td><td>39</td><td>38</td><td>37</td><td>36</td><td>35</td><td>34</td><td>33</td> </tr> <tr> <td>(s3)+3</td> <td>64</td><td>63</td><td>62</td><td>61</td><td>60</td><td>59</td><td>58</td><td>57</td><td>56</td><td>55</td><td>54</td><td>53</td><td>52</td><td>51</td><td>50</td><td>49</td> </tr> <tr> <td>(s3)+4</td> <td>80</td><td>79</td><td>78</td><td>77</td><td>76</td><td>75</td><td>74</td><td>73</td><td>72</td><td>71</td><td>70</td><td>69</td><td>68</td><td>67</td><td>66</td><td>65</td> </tr> <tr> <td>(s3)+5</td> <td>96</td><td>95</td><td>94</td><td>93</td><td>92</td><td>91</td><td>90</td><td>89</td><td>88</td><td>87</td><td>86</td><td>85</td><td>84</td><td>83</td><td>82</td><td>81</td> </tr> <tr> <td>(s3)+6</td> <td>112</td><td>111</td><td>110</td><td>109</td><td>108</td><td>107</td><td>106</td><td>105</td><td>104</td><td>103</td><td>102</td><td>101</td><td>100</td><td>99</td><td>98</td><td>97</td> </tr> <tr> <td>(s3)+7</td> <td>—</td><td>—</td><td>—</td><td>—</td><td>—</td><td>—</td><td>—</td><td>—</td><td>120</td><td>119</td><td>118</td><td>117</td><td>116</td><td>115</td><td>114</td><td>113</td> </tr> </tbody> </table> The default parameter specifies that all stations are 0 (not specified).		b15	b14	b13	b12	b11	b10	b9	b8	b7	b6	b5	b4	b3	b2	b1	b0	(s3)+0	16	15	14	13	12	11	10	9	8	7	6	5	4	3	2	1	(s3)+1	32	31	30	29	28	27	26	25	24	23	22	21	20	19	18	17	(s3)+2	48	47	46	45	44	43	42	41	40	39	38	37	36	35	34	33	(s3)+3	64	63	62	61	60	59	58	57	56	55	54	53	52	51	50	49	(s3)+4	80	79	78	77	76	75	74	73	72	71	70	69	68	67	66	65	(s3)+5	96	95	94	93	92	91	90	89	88	87	86	85	84	83	82	81	(s3)+6	112	111	110	109	108	107	106	105	104	103	102	101	100	99	98	97	(s3)+7	—	—	—	—	—	—	—	—	120	119	118	117	116	115	114	113	Left	User
	b15	b14	b13	b12	b11	b10	b9	b8	b7	b6	b5	b4	b3	b2	b1	b0																																																																																																																																													
(s3)+0	16	15	14	13	12	11	10	9	8	7	6	5	4	3	2	1																																																																																																																																													
(s3)+1	32	31	30	29	28	27	26	25	24	23	22	21	20	19	18	17																																																																																																																																													
(s3)+2	48	47	46	45	44	43	42	41	40	39	38	37	36	35	34	33																																																																																																																																													
(s3)+3	64	63	62	61	60	59	58	57	56	55	54	53	52	51	50	49																																																																																																																																													
(s3)+4	80	79	78	77	76	75	74	73	72	71	70	69	68	67	66	65																																																																																																																																													
(s3)+5	96	95	94	93	92	91	90	89	88	87	86	85	84	83	82	81																																																																																																																																													
(s3)+6	112	111	110	109	108	107	106	105	104	103	102	101	100	99	98	97																																																																																																																																													
(s3)+7	—	—	—	—	—	—	—	—	120	119	118	117	116	115	114	113																																																																																																																																													

*1 Make the setting for the station number that was set with the appropriate setting information setting data.

Error invalid station setting data (for master station setting only)

Operand: (s4)																																																																																																																																																													
Device	Item	Description	Setting range	Set by																																																																																																																																																									
+0 to +7	Station 1 to 120 specification ^{*1}	Specify the error invalid station. • 0: Not specified • 1: Specified Each number in the table indicates a station number. <table border="1" style="margin-left: 40px;"> <thead> <tr> <th></th> <th>b15</th><th>b14</th><th>b13</th><th>b12</th><th>b11</th><th>b10</th><th>b9</th><th>b8</th><th>b7</th><th>b6</th><th>b5</th><th>b4</th><th>b3</th><th>b2</th><th>b1</th><th>b0</th> </tr> </thead> <tbody> <tr> <td>(s4)+0</td> <td>16</td><td>15</td><td>14</td><td>13</td><td>12</td><td>11</td><td>10</td><td>9</td><td>8</td><td>7</td><td>6</td><td>5</td><td>4</td><td>3</td><td>2</td><td>1</td> </tr> <tr> <td>(s4)+1</td> <td>32</td><td>31</td><td>30</td><td>29</td><td>28</td><td>27</td><td>26</td><td>25</td><td>24</td><td>23</td><td>22</td><td>21</td><td>20</td><td>19</td><td>18</td><td>17</td> </tr> <tr> <td>(s4)+2</td> <td>48</td><td>47</td><td>46</td><td>45</td><td>44</td><td>43</td><td>42</td><td>41</td><td>40</td><td>39</td><td>38</td><td>37</td><td>36</td><td>35</td><td>34</td><td>33</td> </tr> <tr> <td>(s4)+3</td> <td>64</td><td>63</td><td>62</td><td>61</td><td>60</td><td>59</td><td>58</td><td>57</td><td>56</td><td>55</td><td>54</td><td>53</td><td>52</td><td>51</td><td>50</td><td>49</td> </tr> <tr> <td>(s4)+4</td> <td>80</td><td>79</td><td>78</td><td>77</td><td>76</td><td>75</td><td>74</td><td>73</td><td>72</td><td>71</td><td>70</td><td>69</td><td>68</td><td>67</td><td>66</td><td>65</td> </tr> <tr> <td>(s4)+5</td> <td>96</td><td>95</td><td>94</td><td>93</td><td>92</td><td>91</td><td>90</td><td>89</td><td>88</td><td>87</td><td>86</td><td>85</td><td>84</td><td>83</td><td>82</td><td>81</td> </tr> <tr> <td>(s4)+6</td> <td>112</td><td>111</td><td>110</td><td>109</td><td>108</td><td>107</td><td>106</td><td>105</td><td>104</td><td>103</td><td>102</td><td>101</td><td>100</td><td>99</td><td>98</td><td>97</td> </tr> <tr> <td>(s4)+7</td> <td>—</td><td>—</td><td>—</td><td>—</td><td>—</td><td>—</td><td>—</td><td>—</td><td>120</td><td>119</td><td>118</td><td>117</td><td>116</td><td>115</td><td>114</td><td>113</td> </tr> </tbody> </table> The default parameter specifies that all stations are 0 (not specified).		b15	b14	b13	b12	b11	b10	b9	b8	b7	b6	b5	b4	b3	b2	b1	b0	(s4)+0	16	15	14	13	12	11	10	9	8	7	6	5	4	3	2	1	(s4)+1	32	31	30	29	28	27	26	25	24	23	22	21	20	19	18	17	(s4)+2	48	47	46	45	44	43	42	41	40	39	38	37	36	35	34	33	(s4)+3	64	63	62	61	60	59	58	57	56	55	54	53	52	51	50	49	(s4)+4	80	79	78	77	76	75	74	73	72	71	70	69	68	67	66	65	(s4)+5	96	95	94	93	92	91	90	89	88	87	86	85	84	83	82	81	(s4)+6	112	111	110	109	108	107	106	105	104	103	102	101	100	99	98	97	(s4)+7	—	—	—	—	—	—	—	—	120	119	118	117	116	115	114	113	Left	User
	b15	b14	b13	b12	b11	b10	b9	b8	b7	b6	b5	b4	b3	b2	b1	b0																																																																																																																																													
(s4)+0	16	15	14	13	12	11	10	9	8	7	6	5	4	3	2	1																																																																																																																																													
(s4)+1	32	31	30	29	28	27	26	25	24	23	22	21	20	19	18	17																																																																																																																																													
(s4)+2	48	47	46	45	44	43	42	41	40	39	38	37	36	35	34	33																																																																																																																																													
(s4)+3	64	63	62	61	60	59	58	57	56	55	54	53	52	51	50	49																																																																																																																																													
(s4)+4	80	79	78	77	76	75	74	73	72	71	70	69	68	67	66	65																																																																																																																																													
(s4)+5	96	95	94	93	92	91	90	89	88	87	86	85	84	83	82	81																																																																																																																																													
(s4)+6	112	111	110	109	108	107	106	105	104	103	102	101	100	99	98	97																																																																																																																																													
(s4)+7	—	—	—	—	—	—	—	—	120	119	118	117	116	115	114	113																																																																																																																																													

*1 Make the setting for the station number that was set with the appropriate setting information setting data.

If both the error invalid and reserved stations are specified for the same station, the reserved station setting will take priority.

Point

Any station numbers outside the range specified by the total number of slave stations or other than those specified in the individual station information settings are ignored even if they are specified as reserved stations or temporary error invalid stations.

For instance, assume that station No.3 and station No.4 are specified as reserved stations with items set as follows: total number of slave stations = 2, information for 1st module = station No.1, information for 2nd module = station No.2, information for 3rd module = station No.3, information for 4th module = station No.4. Since parameters become valid for information of the 1st and 2nd modules only, the reserved station settings for station No.3 and station No.4 are ignored. (In this case, when the total number of slave stations is changed to 4, the reserved station settings for station No.3 and station No.4 become valid.)

Processing details

- Set parameters to the RJ71GN11-T2.

[Own station]

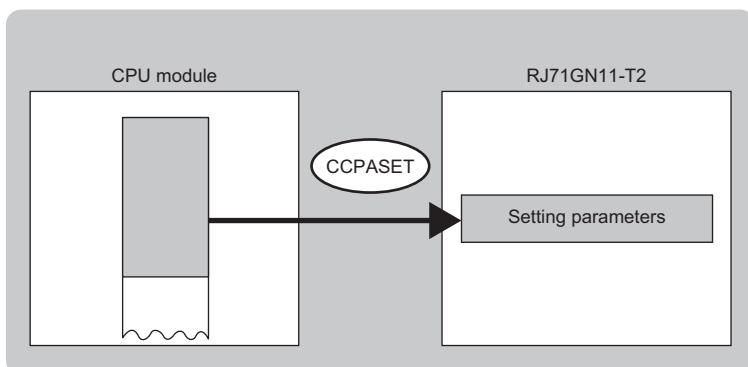

- The execution status and the completion status of the G(P).CCPASET instruction can be checked with the completion device (d) and the completion status indication device (d)+1.

- Completion device (d)

This device turns on during END processing of the scan where the G(P).CCPASET instruction completes, and turns off during the next END processing.

- Completion status indication device (d)+1

This device turns on or off depending on the completion status of the G(P).CCPASET instruction.

When completed successfully: The device remains off.

When completed with an error: The device turns on during END processing of the scan where the G(P).CCPASET instruction completes, and turns off during the next END processing.

Point

The CCPASET instruction can be used when the CCPASET instruction of the CC-Link IE Field Network instruction is applied.

When setting the new parameters to the RJ71GN11-T2, use the CCPASETX instruction.

☞ Page 244 G(P).CCPASETX

Precautions

- The G(P).CCPASET instruction can be executed only once. If this instruction is executed two times or more, an error (error code: DA1AH) is detected.
- Before executing the G(P).CCPASET instruction, execute the UINI instruction or module FB (M+RJ71GN11_SetAddress) and specify the station number and IP address. (Execute them regardless of the setting value of the "Station Number/IP Address Setting" that is set from the module parameter of the engineering tool.)
- For the network configuration setting data (S2), set a same value to the items listed below. If set values are different from each other, an error (error code: 2221H) is detected. (Set values in the same way for the 3rd module or later (slave station).)

Module	Items where a same value must be set	
1st module (master station)	RX/Ry offset ((S2)+1)	RW/r/RWw offset ((S2)+3)
2nd module (slave station)	RX/Ry offset ((S2)+6)	RW/r/RWw offset ((S2)+8)

- Initial values of the module are set for parameters that cannot be set by using the G(P).CCPASET instruction. (MELSEC iQ-R CC-Link IE TSN User's Manual (Application))

Operation error

Error code ((s1)+0)	Description
C000H to CFFFH D000H to DFFFH E000H to EFFFH	MELSEC iQ-R CC-Link IE TSN User's Manual (Application)

5.11 Own Station Number/IP Address Setting

G(P).UINI, Z(P).UINI

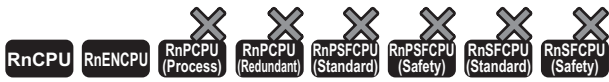

These instructions specify the station number and IP address to the own station which they are not set yet.

Ladder	ST
	<pre> ENO:=G_UINI(EN,U,s,d); ENO:=GP_UINI(EN,U,s,d); ENO:=Z_UINI(EN,U,s,d); ENO:=ZP_UINI(EN,U,s,d); </pre>

FBD/LD

Execution condition

Instruction	Execution condition
G.UINI Z.UINI	
GP.UINI ZP.UINI	

Setting data

Description, range, data type

Operand	Description	Range	Data type	Data type (label)	
(U)	G(P).UINI	Start I/O number (first three digits in four-digit hexadecimal representation) of own station or own node	00H to FEH	16-bit unsigned binary	ANY16
	Z(P).UINI	Start I/O number (first three digits in four-digit hexadecimal representation) of own station or own node	00H to FEH	String	ANY16_OR_STRING_SINGLE
(s)	Own station start device where control data is stored	Page 258 Control data	Device name	ANY16 ^{*1}	
(d)	Device of the own station, which turns on for one scan upon completion of the instruction. When the instruction completes with an error, (d)+1 also turns on.	—	Bit	ANYBIT_ARRAY (Number of elements: 2)	
EN	Execution condition	—	Bit	BOOL	
ENO	Execution result	—	Bit	BOOL	

*1 When specifying data with a label, define the array so that an area required for operation can be secured, and specify the array label element.

■Applicable devices

Operand		Bit		Word			Double word		Indirect specification	Constant			Others (U)
		X, Y, M, L, SM, F, B, SB, FX, FY	J□\□	T, ST, C, D, W, SD, SW, FD, R, ZR, RD	U□\G□, J□\□, U3E□\□(H)G□	Z	LT, LST, LC	LZ		K, H	E	\$	
(U)	G(P).UINI	—	—	○	—	—	—	—	○	○	—	—	○
	Z(P).UINI	—	—	○	—	—	—	—	○	—	—	○	○
(s)		—	—	○*2	—	—	—	—	○	—	—	—	—
(d)		○*1	—	○*3	—	—	—	—	—	—	—	—	—

*1 FX and FY cannot be used.

*2 FD cannot be used.

*3 T, ST, C, and FD cannot be used.

■Control data

Operand: (s)				
Device	Item	Description	Setting range	Set by
+0	Not used	—	—	—
+1	Completion status	The instruction completion status is stored. • 0: Normal • Other than 0: Error (error code)	—	System
+2	Change target specification	0003H (fixed)	0003H	User
+3	Station number of own station	Specifies the station number to be set. • 0: Master station • 1 to 120: Local station	0 to 120	User
+4	IP address	Specify the IP address (third and fourth octets) of the own station. b15 ... b8 b7 ... b0 <input type="text"/>	0000001H to DFFFFFFEH	User
+5		Specify the IP address (first and second octets) of the own station. b15 ... b8 b7 ... b0 <input type="text"/>		User
+6 to +9	Not used	—	—	—

Point

- The UINI instruction can be executed only once.
- If the UINI instruction is executed after the station number and IP address have been determined, it will complete with an error.
- If the UINI instruction completes with an error before the station number and IP address are determined, take corrective action to correct the error content before retrying to execute the instruction.
- Set the subnet mask and default gateway using the engineering tool as necessary.

Processing details

- Sets the station number and IP address for the own station.

[Own station]

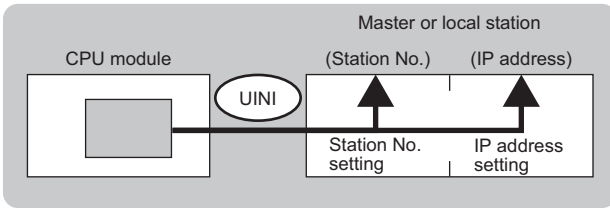

- The execution status and the completion status of the UINI instruction can be checked with the completion device (d) and the completion status indication device (d)+1.

- Completion device (d)

This device turns on during END processing of the scan where the UINI instruction completes, and turns off during the next END processing.

- Completion status indication device (d)+1

This device turns on or off depending on the completion status of the UINI instruction.

When completed successfully: The device remains off.

When completed with an error: The device turns on during END processing of the scan where the UINI instruction completes, and turns off during the next END processing.

5

Precautions

Do not set the broadcast address and the reserved address to the IP address ((s)+4, 5). If set, the instruction may not be executed properly.

Operation error

Error code ((s)+1)	Description
C000H to CFFFH D000H to DFFFH E000H to EFFFH	MELSEC iQ-R CC-Link IE TSN User's Manual (Application)

5.12 Sending an SLMP Message

J(P).SLMPSND, G(P).SLMPSND

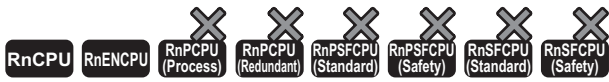

These instructions send/receive an SLMP message to the SLMP-compatible device in the same network.

Ladder	ST
	<pre> ENO:=J_SLMPSND(EN,J,s1,s2,d1,d2); ENO:=JP_SLMPSND(EN,J,s1,s2,d1,d2); ENO:=G_SLMPSND(EN,U,s1,s2,d1,d2); ENO:=GP_SLMPSND(EN,U,s1,s2,d1,d2); </pre>

FBD/LD

Execution condition

Instruction	Execution condition
J.SLMPSND G.SLMPSND	
JP.SLMPSND GP.SLMPSND	

Setting data

Description, range, data type

Operand	Description	Range	Data type	Data type (label)
(J/U)	J(P).SLMPSND (J): Own station network number	1 to 239	16-bit unsigned binary	ANY16
	G(P).SLMPSND (U): Start I/O number (first three digits in four-digit hexadecimal representation) of own station or own node	00H to FEH	16-bit unsigned binary	ANY16
(s1)	Own station start device where control data is stored	Page 261 Control data	Device name	ANY16 ^{*1}
(s2)	Own station start device where request data is stored	Page 263 Request data	Device name	ANY16 ^{*1}
(d1)	Own station start device for storing response data	Page 263 Response data	Device name	ANY16 ^{*1}
(d2)	Device of the own station, which turns on for one scan upon completion of the instruction. When the instruction completes with an error, (d2)+1 also turns on.	—	Bit	ANYBIT_ARRAY (Number of elements: 2)
EN	Execution condition	—	Bit	BOOL
ENO	Execution result	—	Bit	BOOL

*1 When specifying data with a label, define the array so that an area required for operation can be secured, and specify the array label element.

■Applicable devices

Operand		Bit		Word			Double word		Indirect specification	Constant			Others	
		X, Y, M, L, SM, F, B, SB, FX, FY	J□□	T, ST, C, D, W, SD, SW, FD, R, ZR, RD	U□\G□, J□□, U3E□(H)G□	Z	LT, LST, LC	LZ		K, H, E, \$	J, U			
(J/U)	J(P).SLM PSND	—	—	—	—	—	—	—	—	—	—	—	○	—
	G(P).SLM PSND	—	—	○	—	—	—	—	○	—	—	—	—	○
(s1)		—	—	○*2	—	—	—	—	○	—	—	—	—	—
(s2)		—	—	○*2	—	—	—	—	○	—	—	—	—	—
(d1)		—	—	○*2	—	—	—	—	○	—	—	—	—	—
(d2)		○*1	—	○*3	—	—	—	—	—	—	—	—	—	—

*1 FX and FY cannot be used.

*2 FD cannot be used.

*3 T, ST, C, and FD cannot be used.

■Control data

Operand: (s1)								
Device	Item	Description	Setting range	Set by				
+0	Execution/error completion type	b15 ... b7 ... b0 <table border="1" style="margin-left: 20px;"> <tr> <td style="width: 40px;">0</td> <td style="width: 40px;">(2)</td> <td style="width: 40px;">0</td> <td style="width: 40px;">(1)</td> </tr> </table> <p>(1)Execution type (bit 0)</p> <ul style="list-style-type: none"> 0: Without arrival check (The instruction is regarded as completed when a request message is sent from own station.)¹ 1: With arrival check (The instruction is regarded as completed when a response message is received from the external device.) <p>(2)Error completion type (bit 7)</p> <p>Specify whether to set data at completion with an error or not.</p> <ul style="list-style-type: none"> 0: Do not store data at completion with an error in (s1)+13 and later. (The data in (s1)+13 and later will be cleared.) 1: Store data at completion with an error in (s1)+13 and later. 	0	(2)	0	(1)	0000H 0001H 0080H 0081H	User
0	(2)	0	(1)					
+1	Completion status	The instruction completion status is stored. <ul style="list-style-type: none"> 0: Normal Other than 0: Error (error code) 	—	System				
+2	Own station channel	Specify the channel to be used by own station. Whether or not a serial number is given to the request message depends on the channel. ² <ul style="list-style-type: none"> 1: No serial number is set 2 to 9: Serial number is set 10 to 17: Station number extension frame 	1 to 17	User				
+3	IP address of external device	Specify the IP address (third and fourth octets) of external device. b15 ... b8 b7 ... b0 <table border="1" style="margin-left: 20px;"> <tr> <td style="width: 40px;"></td> <td style="width: 40px;"></td> </tr> </table> <ul style="list-style-type: none"> b8 to b15: 3rd octet b0 to b7: 4th octet 			00000001H to DFFFFFFEH	User		
+4	Specify the IP address (first and second octets) of external device. b15 ... b8 b7 ... b0 <table border="1" style="margin-left: 20px;"> <tr> <td style="width: 40px;"></td> <td style="width: 40px;"></td> </tr> </table> <ul style="list-style-type: none"> b8 to b15: 1st octet b0 to b7: 2nd octet 			User				
+5	Destination port number	Specify the destination port number. For the available port number, refer to the manual of the external device.	1 to FFFE (1 to 65534)	User				
+6	Request destination network number	0000H (fixed)	0000H	User				
+7	Request destination station number	00FFH (fixed)	00FFH	User				

Operand: (s1)																
Device	Item	Description	Setting range	Set by												
+8	Request destination module I/O number	Specify a module I/O number of the request destination. <ul style="list-style-type: none"> • 03E0H: Multiple CPU No.1 • 03E1H: Multiple CPU No.2 • 03E2H: Multiple CPU No.3 • 03E3H: Multiple CPU No.4 • 03FFH: Own station/control CPU 	03E0H to 03E3H and 03FFH	User												
+9	Request destination multidrop station number	0000H (fixed)	0000H	User												
+10	Number of resends	Effective when the execution type specified by the bit 0 in (s1) is "1: Arrival acknowledgment used". ■At instruction execution Specify the number of resends to be performed if the instruction is not completed within the monitoring time specified by (s1)+11. <ul style="list-style-type: none"> • 0 to 15 times ■At completion of instruction The number of resends performed (result) is stored. <ul style="list-style-type: none"> • 0 to 15 times^{*3} 	0 to 15	User/system												
+11	Arrival monitoring time	Specify the monitoring time until completion of processing. If the processing is not completed within the monitoring time, data is resent until the value specified in "(s1)+10" is reached. <ul style="list-style-type: none"> • 0: 10s • 1 to 32767: 1 to 32767s 	0 to 32767	User												
+12	Clock setting flag	The validity status (valid or invalid) of the data in (s1)+13 and later is stored. Note that the data in (s1)+13 and later is cleared when the instruction is completed successfully. <ul style="list-style-type: none"> • 0: Invalid • 1: Valid 	—	System												
+13	Clock data	Upper 8 bits: Month (01H to 12H) Lower 8 bits: Lower 2 digits of year (00H to 99H)	—	System												
+14		Upper 8 bits: Hour (00H to 23H) Lower 8 bits: Day (01H to 31H)	—	System												
+15		Upper 8 bits: Second (00H to 59H) Lower 8 bits: Minute (00H to 59H)	—	System												
+16		Upper 8 bits: Upper 2 digits of year (00H to 99H) Lower 8 bits: Day of the week (00H (Sun.) to 06H (Sat.))	—	System												
+17		Error-detected device IP address	The IP address (third and fourth octets) of the station where an error was detected is stored. <table border="1" style="width: 100%; border-collapse: collapse;"> <tr> <td style="text-align: center;">b15</td> <td style="text-align: center;">...</td> <td style="text-align: center;">b8</td> <td style="text-align: center;">b7</td> <td style="text-align: center;">...</td> <td style="text-align: center;">b0</td> </tr> <tr> <td colspan="6" style="text-align: center;"> <div style="border: 1px solid black; width: 100%; height: 15px; margin-bottom: 5px;"></div> </td> </tr> </table> <ul style="list-style-type: none"> • b8 to b15: 3rd octet • b0 to b7: 4th octet 	b15	...	b8	b7	...	b0	<div style="border: 1px solid black; width: 100%; height: 15px; margin-bottom: 5px;"></div>						—
b15	...		b8	b7	...	b0										
<div style="border: 1px solid black; width: 100%; height: 15px; margin-bottom: 5px;"></div>																
+18	The IP address (first and second octets) of the station where an error was detected is stored. <table border="1" style="width: 100%; border-collapse: collapse;"> <tr> <td style="text-align: center;">b15</td> <td style="text-align: center;">...</td> <td style="text-align: center;">b8</td> <td style="text-align: center;">b7</td> <td style="text-align: center;">...</td> <td style="text-align: center;">b0</td> </tr> <tr> <td colspan="6" style="text-align: center;"> <div style="border: 1px solid black; width: 100%; height: 15px; margin-bottom: 5px;"></div> </td> </tr> </table> <ul style="list-style-type: none"> • b8 to b15: 1st octet • b0 to b7: 2nd octet 	b15	...	b8	b7	...	b0	<div style="border: 1px solid black; width: 100%; height: 15px; margin-bottom: 5px;"></div>						—	System	
b15	...	b8	b7	...	b0											
<div style="border: 1px solid black; width: 100%; height: 15px; margin-bottom: 5px;"></div>																

*1 When the execution type specified by the bit 0 in (s1) is "0: No arrival acknowledgment", the response message is not received. Specify this type when a command that does not return a response message is used or when a response message is not referred.

Command that does not return a response message is used: Remote Reset (command: 1006)

*2 Set the serial numbers when sending multiple request messages to the same SLMP-compatible device. Serial numbers to be set are automatically numbered by the system. For details on the serial number, refer to the following.

SLMP Reference Manual

*3 If an error was detected, the number of resends performed (result) between error detection and resend stop is stored.

■Request data

Operand: (s2)				
Device	Item	Description	Setting range	Set by
+0	Request data length	Specify the data length from the monitoring timer to the request data. (Unit: Byte)	1 to 2000	User
+1	Monitoring timer	Sets the waiting time for the external device that received a request message to wait for the response after it issued a processing request to the access destination. (Unit: Increments of 250ms) <ul style="list-style-type: none"> • 0: Infinite wait • 1 to 65535: 1 to 65535 × 250ms 	0 to 65535	User
+2 to +□	Request data	The request data of the SLMP message is stored. For details on the request data, refer to the following.  SLMP Reference Manual	Refer to the specifications of the external device.	User

■Response data

Operand: (d1)				
Device	Item	Description	Setting range	Set by
+0	Response data length	The data length from the end code to the response data is stored. (Unit: Byte)	—	System
+1	End code	Stores the result of command processing of the request data. In normal end, 0 is stored. In abnormal end, an error code of the external device is stored. For details, refer to the following.	—	System
+2 to +□	Response data	Stores the data such as the read data for the request data. (Some commands do not return response data.) For details on the response data, refer to the following.  SLMP Reference Manual	—	System

Processing details

- This instruction sends the request data in the device specified by (s2) and later to the external device specified by the external device IP address in the control data. When a response message is received from the external device, it is stored in the device specified by (d1).
- The SLMPSND instruction uses the UDP/IP communication methods in binary code.
- The execution status and the completion status of the SLMPSND instruction can be checked with the completion device (d2) and the completion status indication device (d2)+1.
 - Completion device (d2)
This device turns on during END processing of the scan where the SLMPSND instruction completes, and turns off during the next END processing.
 - Completion status indication device (d2)+1
This device turns on or off depending on the completion status of the SLMPSND instruction.
When completed successfully: The device remains off.
When completed with an error: The device turns on during END processing of the scan where the SLMPSND instruction completes, and turns off during the next END processing.
- When executing multiple SLMPSND instructions concurrently, be careful not to overlap the channels of the SLMPSND instructions. Multiple SLMPSND instructions specifying the same channels cannot be used concurrently.
- When the execution conditions of the SLMPSND instructions in the same channel are satisfied in the same sequence scan, only the SLMPSND instruction that has been executed first is enabled and the subsequent SLMPSND instructions are not executed. In addition, any subsequent SLMPSND instruction of the same channel setting as the SLMPSND instruction being executed is not executed.
- Specify the arrival monitoring time ((s1)+11) of the control data and monitoring timer ((s2)+1) of the request frame so that the arrival monitoring time \geq monitoring timer.

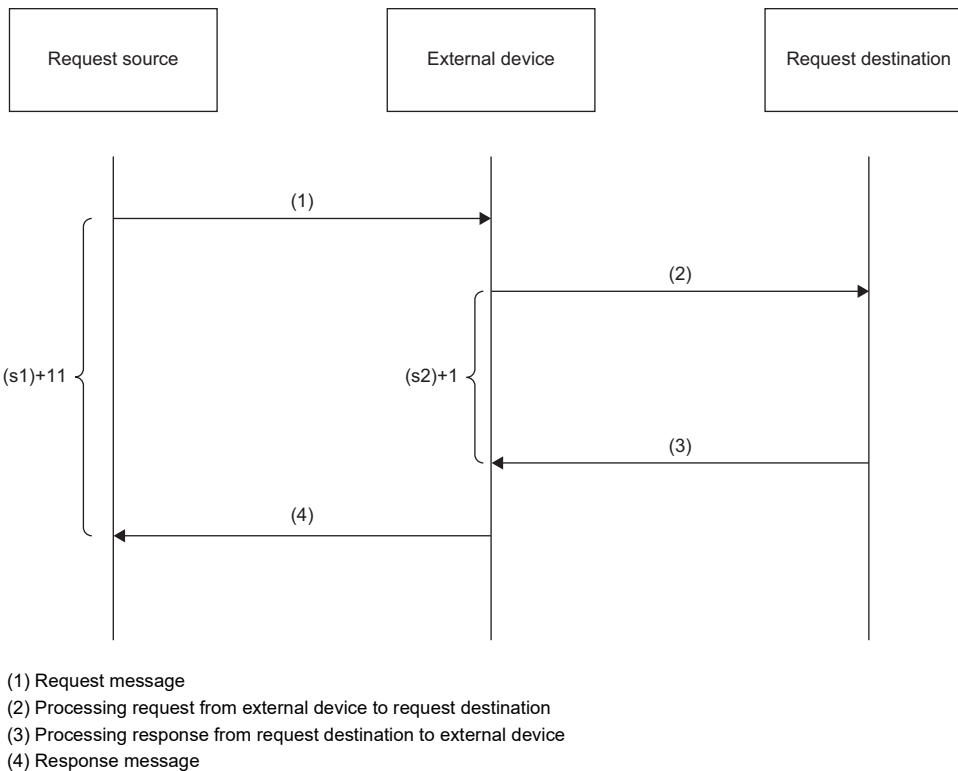

■ Message format (3E/4E frame)

The following figures show the request data of 3E/4E frame and the response data in normal/abnormal end.

• Request message

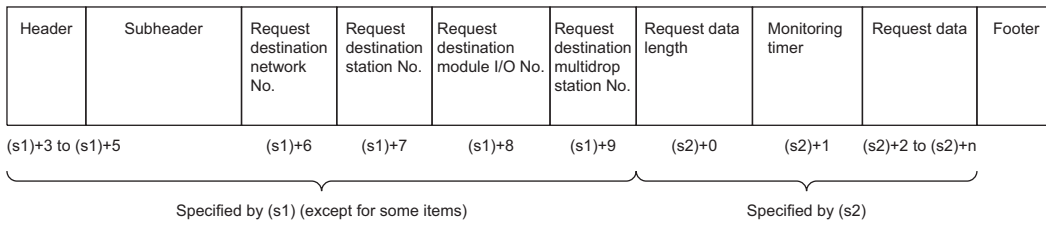

• Response message (in normal end)

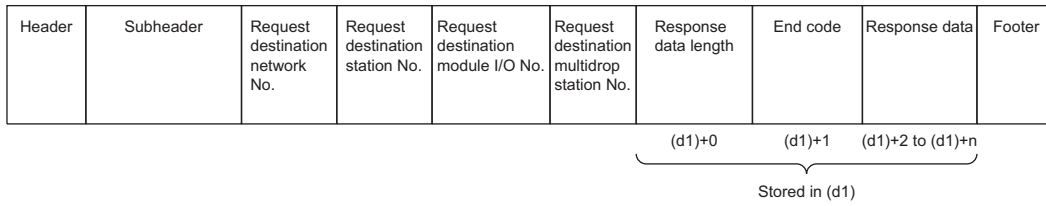

• Response message (in abnormal end)

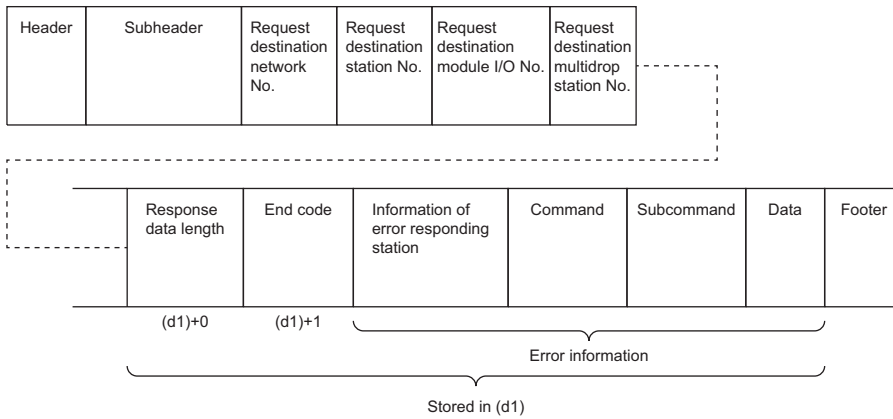

The network number, station number, request destination module I/O number, and multidrop station number are stored to the information of the error responding station.

■Message format (station number extension frame)

The following figures show the request data of station number extension frame and the response data in normal/abnormal end.

• Request message

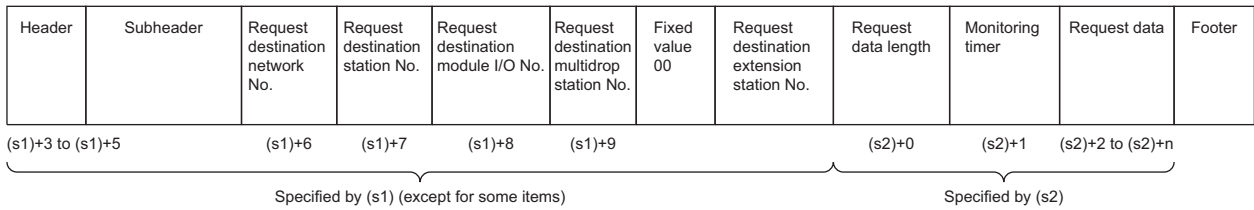

• Response message (in normal end)

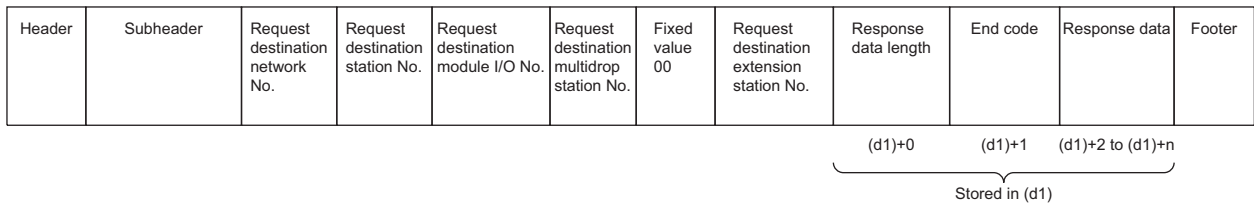

• Response message (in abnormal end)

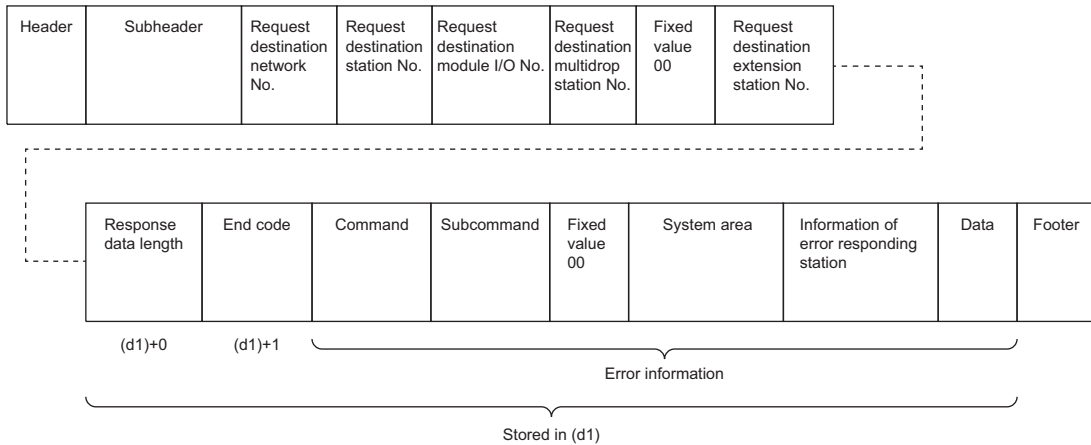

The network number, station number, request destination module I/O number, multidrop station number, 00 (fixed value), and extension station number are stored to the information of the error responding station.

Ex.

When sending "Read (command: 0401H)" (reading in units of words) which reads the value in D100 to D102

- The following example shows that request data is stored in (s2)+2 and later (3E/4E frame).

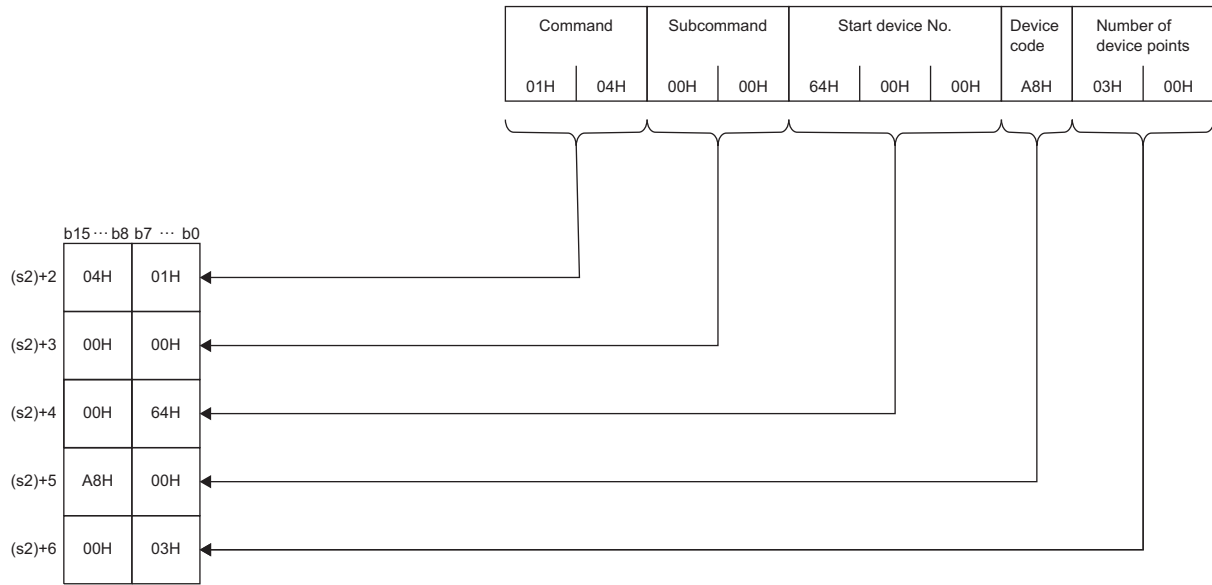

- The following example shows that response data is stored in (d1)+2 and later (3E/4E frame).

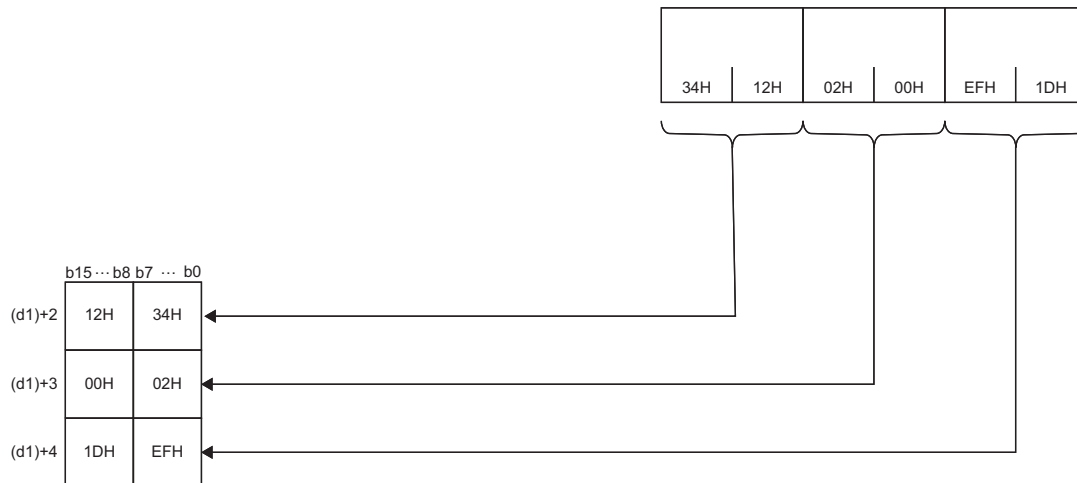

- The following example shows that request data is stored in (s2)+2 and later (station number extension frame).

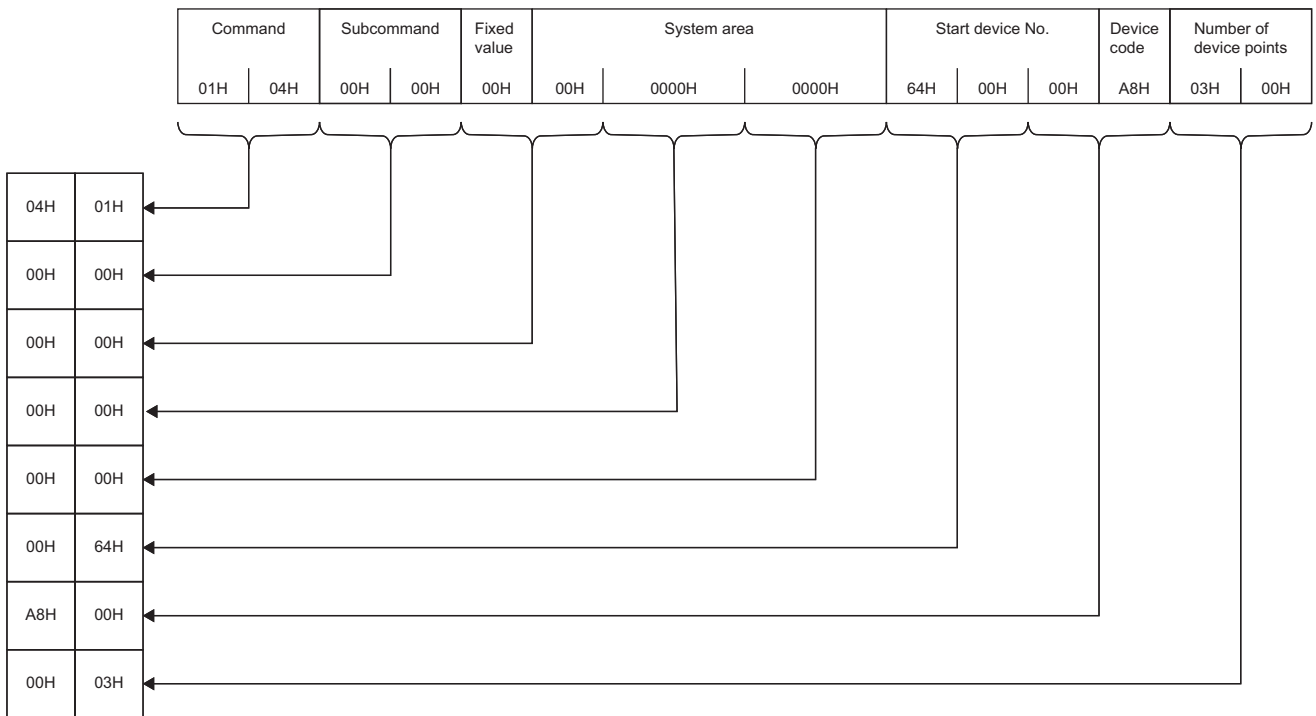

- The following example shows that response data is stored in (d1)+2 and later (station number extension frame).

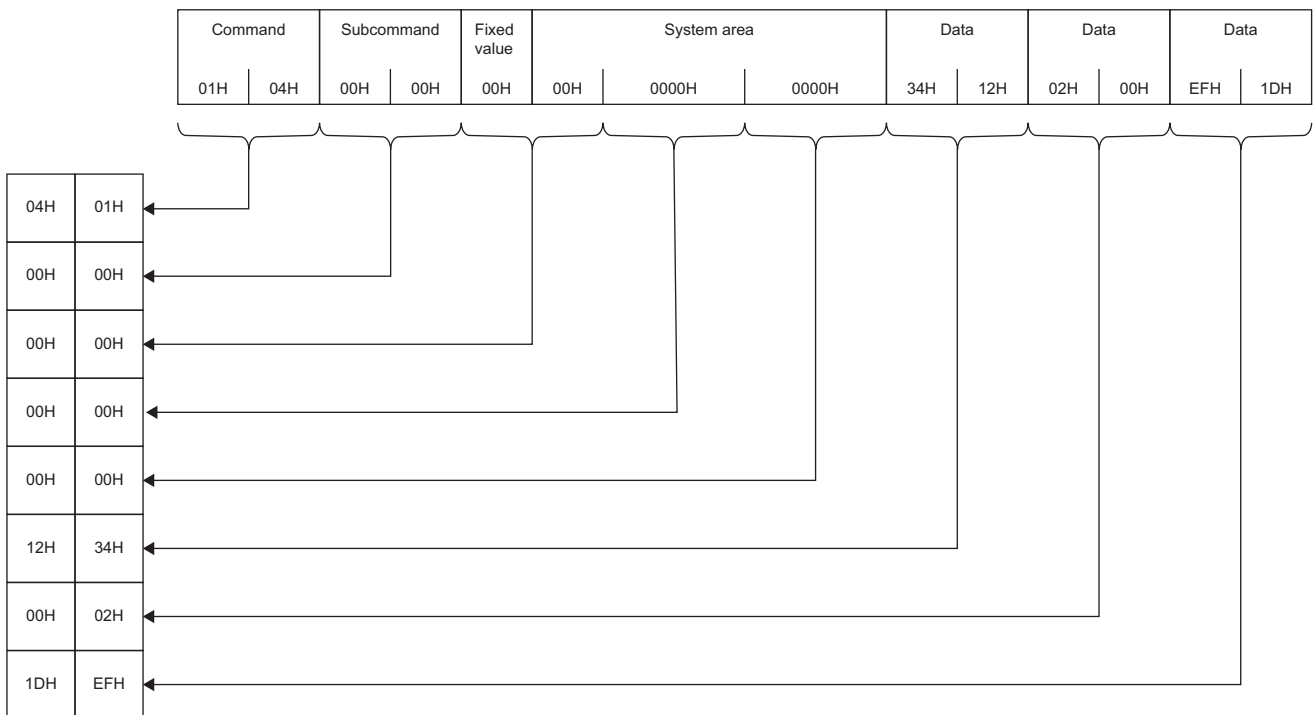

Operation error

Error code ((s1)+1)	Description
1000H to 3FFFH	MELSEC iQ-R CC-Link IE TSN User's Manual (Application)
4000H to 4FFFH	MELSEC iQ-R CPU Module User's Manual (Application)
D000H to DFFFH	MELSEC iQ-R CC-Link IE TSN User's Manual (Application)

Point 

The SLMPSND instruction is successfully completed even if the target device returns an abnormal response. When the SLMPSND instruction is completed successfully, the response is whether normal or abnormal can be identified by the end code of the response frame. When an abnormal response is returned, check the manual of the SLMP-compatible device being used and take corrective action.

6 CC-Link IE Controller Network AND MELSECNET/H COMMON INSTRUCTIONS

Point

This chapter describes the instructions used commonly by MELSEC iQ-R series modules. For the instructions when MELSEC-Q series modules are used, refer to the manuals for each module used and create programs. For precautions when using modules, refer to the following.

MELSEC iQ-R Module Configuration Manual

6.1 Remote RUN

J(P).RRUN, G(P).RRUN, Z(P).RRUN



These instructions execute remote RUN for the programmable controller on another station.

Ladder	ST
	<pre> ENO:=J_RRUN(EN,J,s1,s2,s3,s4,d); ENO:=JP_RRUN(EN,J,s1,s2,s3,s4,d); ENO:=G_RRUN(EN,U,s1,s2,s3,s4,d); ENO:=GP_RRUN(EN,U,s1,s2,s3,s4,d); ENO:=Z_RRUN(EN,J/U,s1,s2,s3,s4,d); ENO:=ZP_RRUN(EN,J/U,s1,s2,s3,s4,d); </pre>

FBD/LD

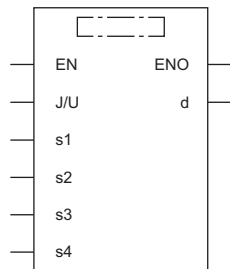

Execution condition

Instruction	Execution condition
J.RRUN G.RRUN Z.RRUN	
JP.RRUN GP.RRUN ZP.RRUN	

Setting data

■Description, range, data type

Operand		Description	Range	Data type	Data type (label)																		
(J/U)	J(P).RRUN	(J): Target station network number	1 to 239	16-bit unsigned binary	ANY16																		
	G(P).RRUN	(U): Start I/O number (first three digits in four-digit hexadecimal representation) of own station or own node	00H to FEH	16-bit unsigned binary	ANY16																		
	Z(P).RRUN	(J): Target station network number	1 to 239	String	ANY16_OR_STRING_SINGLE																		
	Z(P).RRUN	(U): Start I/O number (first three digits in four-digit hexadecimal representation) of own station or own node	00H to FEH	String	ANY16_OR_STRING_SINGLE																		
(s1)		Own station channel ( Page 66 Range of available channels) Specifies the channel to be used by the own station or node. Specify the channel that was specified, as being used by the own station, in the RSTOP instruction.	—	16-bit unsigned binary	ANY16																		
(s2)		Specify the station number of the target station/target node. (1) Station number specification [Ethernet or CC-Link IE Controller Network] • 1 to 120 [MELSECNET/H] • 1 to 64 (2) Group specification ^{*1} 81H to A0H: All stations of group numbers 1 to 32 (3) All-station specification ^{*1} FFH: All stations of target network numbers, except own station	—	16-bit unsigned binary	ANY16																		
(s3)		Specify that CPU module in the target station that is to be accessed. • 0000H: Addressed to target station CPU (control CPU) • 03D0H: Addressed to control system CPU ^{*2} • 03D1H: Addressed to standby system CPU ^{*2} • 03D2H: Addressed to system A CPU • 03D3H: Addressed to system B CPU • 03E0H: Addressed to multiple CPU No. 1 • 03E1H: Addressed to multiple CPU No. 2 • 03E2H: Addressed to multiple CPU No. 3 • 03E3H: Addressed to multiple CPU No. 4 • 03FFH: Addressed to target station CPU (control CPU)	—	16-bit unsigned binary	ANY16																		
(s4)		Specify the operation and clear modes. <table border="1" style="margin-left: 20px;"> <tr> <td style="text-align: center;">b15</td> <td style="text-align: center;">...</td> <td style="text-align: center;">b8</td> <td style="text-align: center;">b7</td> <td style="text-align: center;">...</td> <td style="text-align: center;">b4</td> <td style="text-align: center;">b3</td> <td style="text-align: center;">...</td> <td style="text-align: center;">b0</td> </tr> <tr> <td style="text-align: center;">0</td> <td></td> <td style="text-align: center;">(2)</td> <td></td> <td></td> <td style="text-align: center;">(1)</td> <td></td> <td></td> <td></td> </tr> </table> (1) Operation mode Specifies whether or not remote RUN be forcibly executed. • 1H: Not forcibly executed • 3H: Forcibly executed The forcible execution function forcibly executes remote RUN from another station when the station that executed remote STOP can no longer execute remote RUN. (2) Clear mode Specifies the CPU unit device status resulting after remote RUN is executed. • 0H: Not cleared, except local devices • 1H: Cleared, except the latch range • 2H: Cleared, including the latch range The clear mode setting specifies the clear, or initialization, processing for the CPU module device at the operation start of CPU module calculation by remote RUN. After completion of the specified clear processing, the CPU module executes RUN according to the initial device values of the engineering tool.	b15	...	b8	b7	...	b4	b3	...	b0	0		(2)			(1)				—	16-bit unsigned binary	ANY16
b15	...	b8	b7	...	b4	b3	...	b0															
0		(2)			(1)																		
(d)		Device of the own station, which turns on for one scan upon completion of the instruction. When the instruction completes with an error, (d)+1 also turns on.	—	Bit	ANYBIT_ARRAY (Number of elements: 2)																		
EN		Execution condition	—	Bit	BOOL																		
ENO		Execution result	—	Bit	BOOL																		

- *1 If the instruction is executed with group or all stations specification:
For the target station CPU type (s3), specify either 0000H or 03FFH. If the target station is in CC-Link IE Field Network, group specification is not available. To check that the data has been written successfully in the target station, examine whether the CPU module of the destination has entered the RUN state.
- *2 If the instruction is executed with the control system CPU (03D0H) or standby system CPU (03D1H) specified, it may complete with an error if system switching occurs in the target station (error code: 4244H, 4248H).
Retry to execute the instruction if it completed with an error due to the above error.

Point

- Remote RUN is enabled when the RUN/STOP/RESET switch of the target station CPU module is "RUN".
- If the target station CPU module is system protected, remote RUN will fail.
- If the target station CPU module has already been remotely stopped or paused from another station, RUN will fail if (s4) is "Not forcibly executed (0001H)".

Applicable devices

Operand	Bit	Word				Double word		Indirect specification	Constant			Others		
		X, Y, M, L, SM, F, B, SB, FX, FY	J□□□	T, ST, C, D, W, SD, SW, FD, R, ZR, RD	U□\G□, J□□□, U3E□(H)G□	Z	LT, LST, LC		LZ	K, H, E, \$	J, U			
(J/U)	J(P).R RUN	—	—	—	—	—	—	—	—	—	—	—	—	—
	G(P).RRUN	—	—	○	—	—	—	○	○	—	—	—	—	○
	Z(P).R RUN	—	—	○	—	—	—	○	—	—	○	○	○	○
(s1)	○*1	—	—	○*2	—	—	—	○	○	—	—	—	—	—
(s2)	○*1	—	—	○*2	—	—	—	○	○	—	—	—	—	—
(s3)	○*1	—	—	○*2	—	—	—	○	○	—	—	—	—	—
(s4)	○*1	—	—	○*2	—	—	—	○	○	—	—	—	—	—
(d)	○*1	—	—	○*3	—	—	—	—	—	—	—	—	—	—

- *1 FX and FY cannot be used.
- *2 FD cannot be used.
- *3 T, ST, C, and FD cannot be used.

Processing details

- Remote RUN is executed for the target station CPU module according to the (s4) specification details. The target station is specified with the target network number (J) or the start I/O number (U) of the own station or node and the target station number (s2). After completion of request to the target station, the completion device specified by (d) turns on.

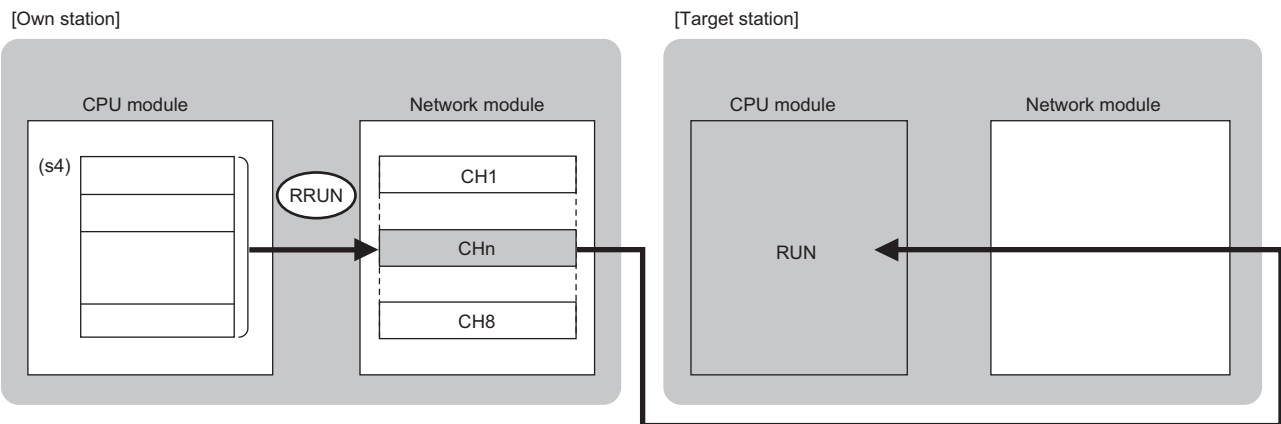

CH: Channel

- The specifiable stations are those with the specified network number that are included in one of the following networks.
 - MELSECNET/H
 - MELSECNET/10
 - CC-Link IE Controller Network
 - CC-Link IE Field Network
 - Ethernet

- The execution status and the completion status of the RRUN instruction can be checked with the completion device (d) and the completion status indication device (d)+1.

- Completion device (d)

This device turns on during END processing of the scan where the RRUN instruction completes, and turns off during the next END processing.

- Completion status indication device (d)+1

This device turns on or off depending on the completion status of the RRUN instruction.

When completed normally: Unchanged from off.

When completed with an error: The device turns on during END processing of the scan where the RRUN instruction completes, and turns off during the next END processing.

- The following figure shows the RRUN instruction execution timing.

- When completed successfully

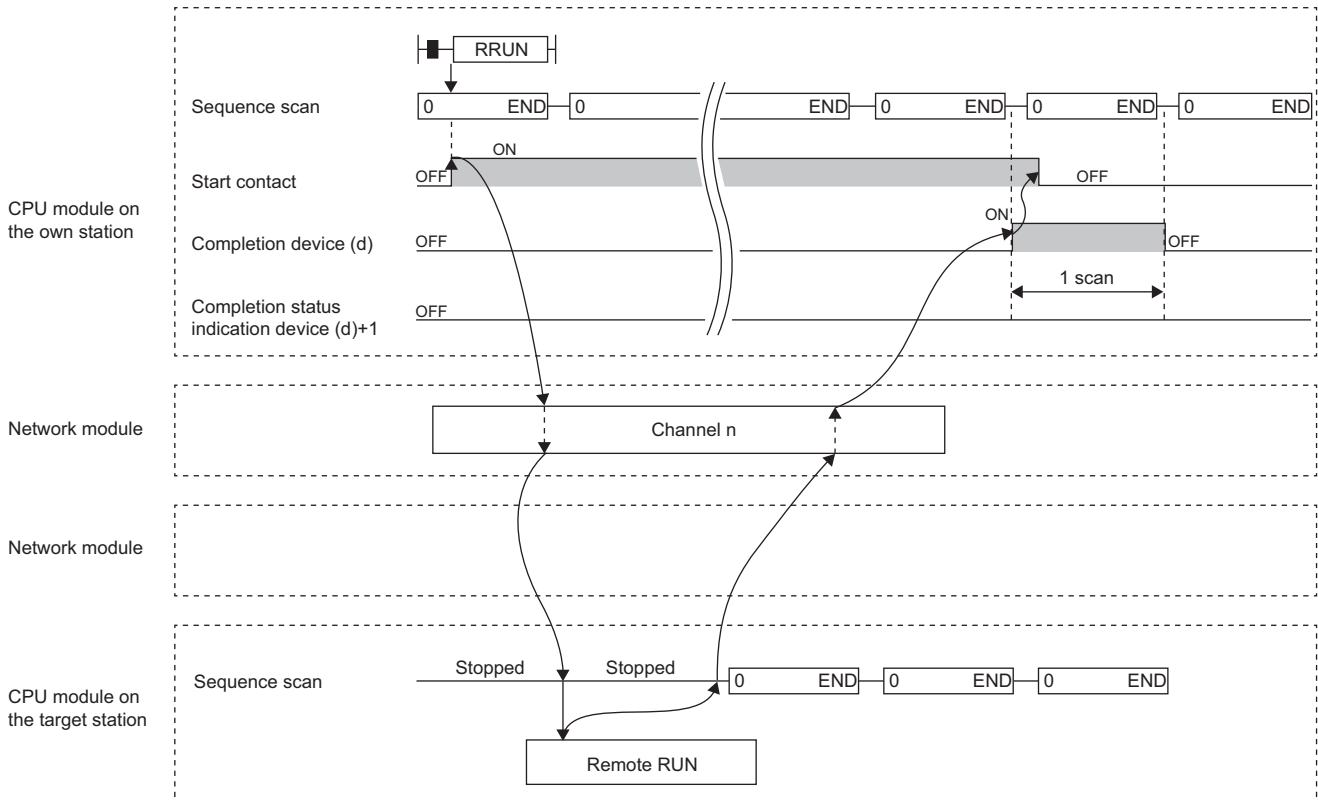



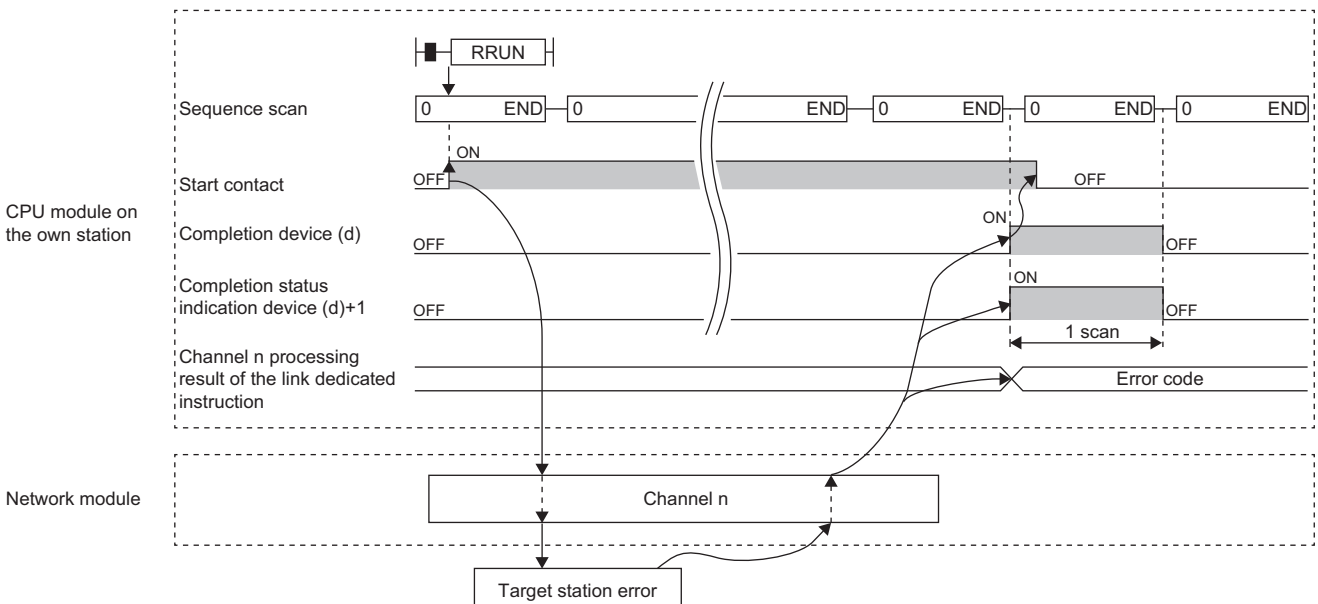

- When completed with an error



- If the J.RRUN, G.RRUN, or Z.RRUN is used to execute processing, processing of one time is successively followed by the next processing while the start-up contact is on.
- If the JP.RRUN, GP.RRUN, or ZP.RRUN is used to execute processing, processing is executed once at the start-up contact off-to-on rise.

Operation error

Error code*4	Description
4000H to 4FFFH	 MELSEC iQ-R CPU Module User's Manual (Application)
6F00H to 6FFFH	 MELSEC iQ-R CPU Module User's Manual (Application)
E000H to EFFFH	 MELSEC iQ-R CC-Link IE Controller Network User's Manual (Application)
F000H to FFFFH	 MELSEC iQ-R MELSECNET/H Network Module User's Manual (Application)

*4 The storage location which is stored an error code is as follows.

CC-Link IE Controller Network: SW0030 to SW0037

Ethernet: SW0030 to SW0037

MELSECNET/H: SW0031, SW0033, SW0035, SW0037, SW0039, SW003B, SW003D, SW003F

6.2 Remote STOP

J(P).RSTOP, G(P).RSTOP, Z(P).RSTOP



These instructions execute remote STOP for the programmable controller on another station.

Ladder	ST
	<pre> ENO:=J_RSTOP(EN,J,s1,s2,s3,s4,d); ENO:=JP_RSTOP(EN,J,s1,s2,s3,s4,d); ENO:=G_RSTOP(EN,U,s1,s2,s3,s4,d); ENO:=GP_RSTOP(EN,U,s1,s2,s3,s4,d); ENO:=Z_RSTOP(EN,J/U,s1,s2,s3,s4,d); ENO:=ZP_RSTOP(EN,J/U,s1,s2,s3,s4,d); </pre>

FBD/LD

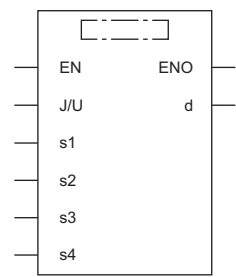

Execution condition

Instruction	Execution condition
J.RSTOP G.RSTOP Z.RSTOP	
JP.RSTOP GP.RSTOP ZP.RSTOP	

Setting data

■Description, range, data type

Operand	Description	Range	Data type	Data type (label)	
(J/U)	J(P).RSTOP	(J): Target station network number	1 to 239	16-bit unsigned binary	ANY16
	G(P).RSTOP	(U): Start I/O number (first three digits in four-digit hexadecimal representation) of own station or own node	00H to FEH	16-bit unsigned binary	ANY16
	Z(P).RSTOP	(J): Target station network number	1 to 239	String	ANY16_OR_STRING_SINGLE
	Z(P).RSTOP	(U): Start I/O number (first three digits in four-digit hexadecimal representation) of own station or own node	00H to FEH	String	ANY16_OR_STRING_SINGLE
(s1)	Own station channel ( Page 66 Range of available channels)	—	16-bit unsigned binary	ANY16	
(s2)	Specify the station number of the target station/target node. (1) Station number specification [Ethernet or CC-Link IE Controller Network] • 1 to 120 [MELSECNET/H] • 1 to 64 (2) Group specification*1 81H to A0H: All stations of group numbers 1 to 32 (3) All-station specification*1 FFH: All stations of target network numbers, except own station	—	16-bit unsigned binary	ANY16	
(s3)	Specify that CPU module in the target station that is to be accessed. • 0000H: Addressed to target station CPU (control CPU) • 03D0H: Addressed to control system CPU*2 • 03D1H: Addressed to standby system CPU*2 • 03D2H: Addressed to system A CPU • 03D3H: Addressed to system B CPU • 03E0H: Addressed to multiple CPU No. 1 • 03E1H: Addressed to multiple CPU No. 2 • 03E2H: Addressed to multiple CPU No. 3 • 03E3H: Addressed to multiple CPU No. 4 • 03FFH: Addressed to target station CPU (control CPU)	—	16-bit unsigned binary	ANY16	
(s4)	Specifies the operation mode. (0001H (fixed))	0001H (fixed)	16-bit unsigned binary	ANY16	
(d)	Device of the own station, which turns on for one scan upon completion of the instruction. When the instruction completes with an error, (d)+1 also turns on.	—	Bit	ANYBIT_ARRAY (Number of elements: 2)	
EN	Execution condition	—	Bit	BOOL	
ENO	Execution result	—	Bit	BOOL	

*1 If the instruction is executed with group or all stations specification:

For the target station CPU type (s3), specify either 0000H or 03FFH. If the target station is in CC-Link IE Field Network, group specification is not available. To check that the data has been written successfully in the target station, examine whether the CPU module of the destination has entered the STOP state.

*2 If the instruction is executed with the control system CPU (03D0H) or standby system CPU (03D1H) specified, it may complete with an error if system switching occurs in the target station (error code: 4244H, 4248H).

Retry to execute the instruction if it completed with an error due to the above error.

Point

- Remote STOP is enabled when the RUN/STOP/RESET switch of the target station CPU module is "RUN".
- If the target station CPU module is system protected, remote STOP will fail.
- Resetting the target station CPU on which remote STOP was executed deletes information about the remote STOP.

■Applicable devices

Operand		Bit		Word			Double word		Indirect specification	Constant			Others	
		X, Y, M, L, SM, F, B, SB, FX, FY	J□□	T, ST, C, D, W, SD, SW, FD, R, ZR, RD	U□□□, J□□□, U3E□□(H)□□	Z	LT, LST, LC	LZ		K, H	E	\$	J	U
(J/U)	J(P).RSTOP	—	—	—	—	—	—	—	—	—	—	—	○	—
	G(P).RSTOP	—	—	○	—	—	—	—	○	—	—	—	—	○
	Z(P).RSTOP	—	—	○	—	—	—	—	○	—	—	○	○	○
(s1)		○*1	—	○*2	—	—	—	—	○	—	—	—	—	—
(s2)		○*1	—	○*2	—	—	—	—	○	—	—	—	—	—
(s3)		○*1	—	○*2	—	—	—	—	○	—	—	—	—	—
(s4)		○*1	—	○*2	—	—	—	—	○	—	—	—	—	—
(d)		○*1	—	○*3	—	—	—	—	—	—	—	—	—	—

*1 FX and FY cannot be used.

*2 FD cannot be used.

*3 T, ST, C, and FD cannot be used.

Processing details

- Remote STOP is executed for the target station CPU module. The target station is specified with the target network number (J) or the start I/O number (U) of the own station or node and the target station number (s2). After completion of request to the target station, the completion device specified by (d) turns on.

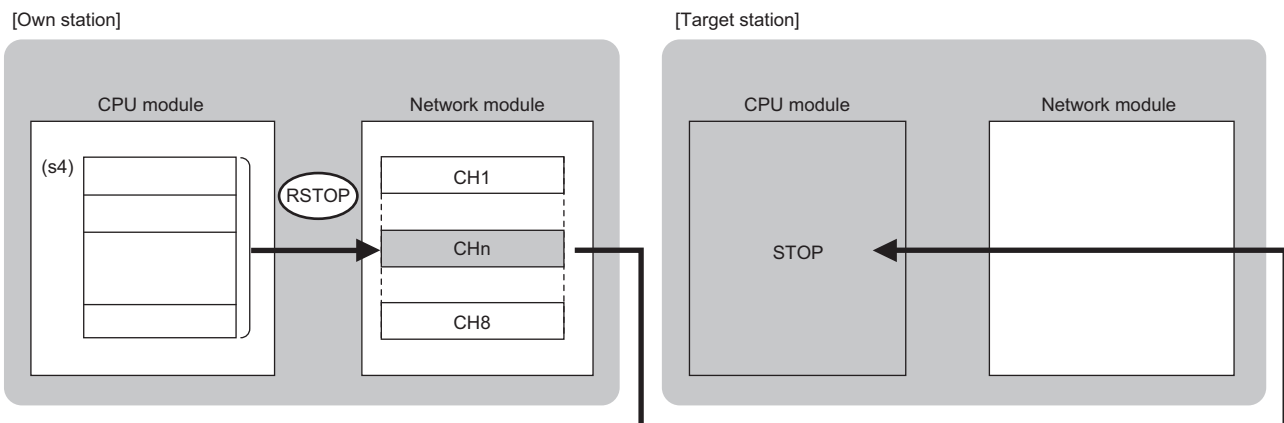

CH: Channel

- The specifiable stations are those with the specified network number that are included in one of the following networks.
 - MELSECNET/H
 - MELSECNET/10
 - CC-Link IE Controller Network
 - CC-Link IE Field Network
 - Ethernet
- The execution status and the completion status of the RSTOP instruction can be checked with the completion device (d) and the completion status indication device (d)+1.

- Completion device (d)

This device turns on during END processing of the scan where the RSTOP instruction completes, and turns off during the next END processing.

- Completion status indication device (d)+1

This device turns on or off depending on the completion status of the RSTOP instruction.

When completed successfully: The device remains off.

When completed with an error: The device turns on during END processing of the scan where the RSTOP instruction completes, and turns off during the next END processing.

- The following figure shows the RSTOP instruction execution timing.
- When completed successfully

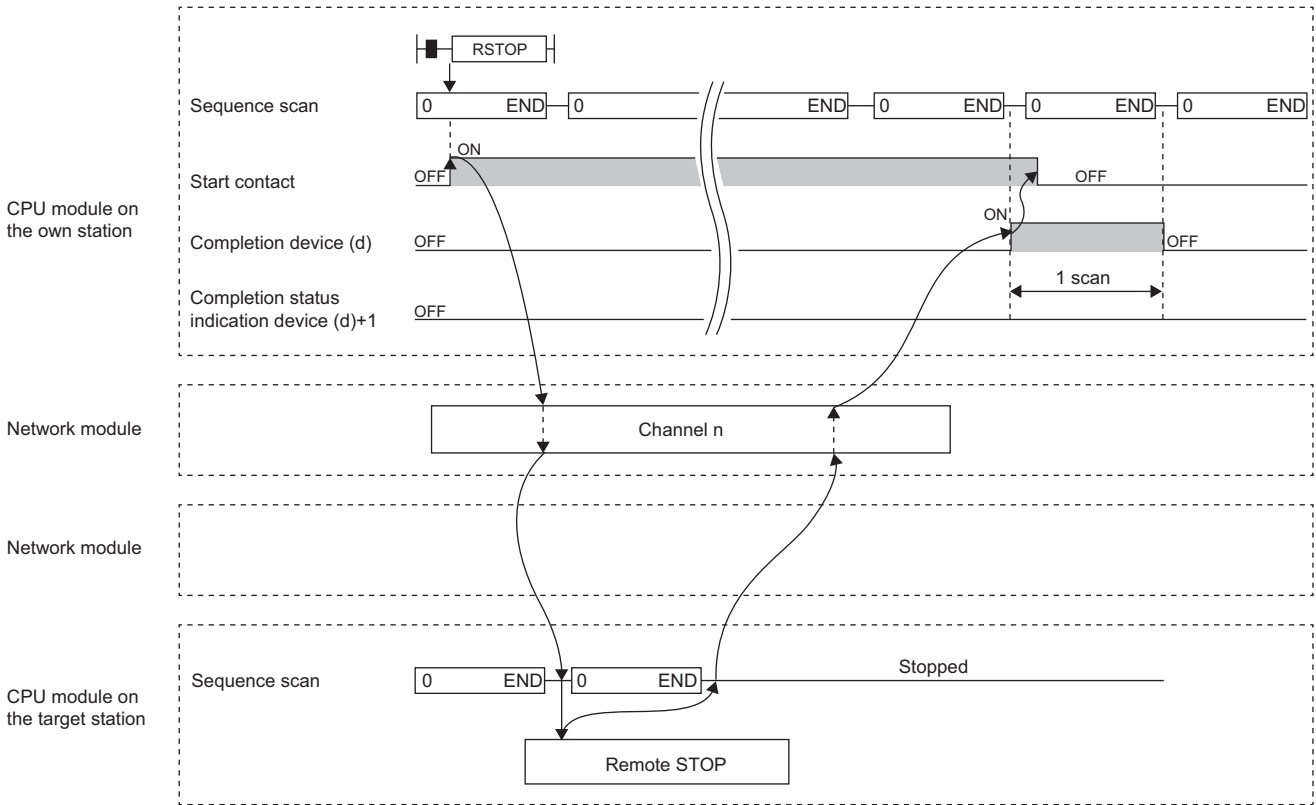



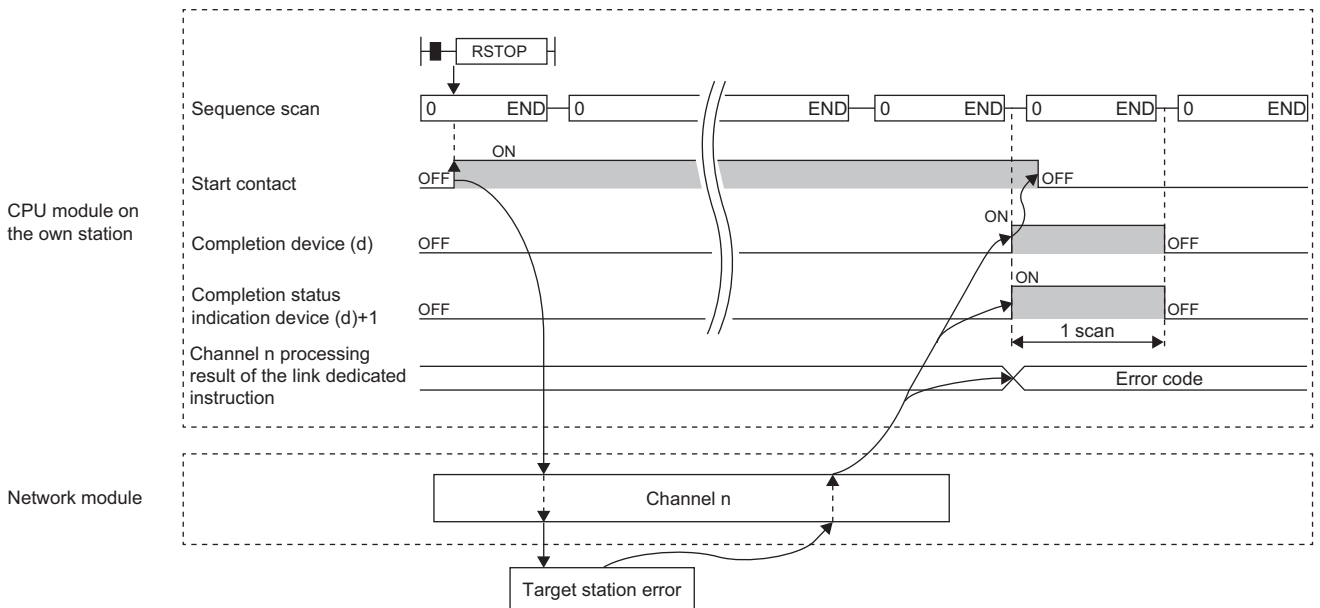

Depending on the system configuration and sequence scan time, several scans may be required until the sequence scan STOP completes.

- When completed with an error



- If the J.RSTOP, G.RSTOP, or Z.RSTOP is used to execute processing, processing of one time is successively followed by the next processing while the start-up contact is on.
- If the JP.RSTOP, GP.RSTOP, or ZP.RSTOP is used to execute processing, processing is executed once at the start-up contact off-to-on rise.

Operation error

Error code*4	Description
4000H to 4FFFH	 MELSEC iQ-R CPU Module User's Manual (Application)
6F00H to 6FFFH	 MELSEC iQ-R CPU Module User's Manual (Application)
E000H to EFFFH	 MELSEC iQ-R CC-Link IE Controller Network User's Manual (Application)
F000H to FFFFH	 MELSEC iQ-R MELSECNET/H Network Module User's Manual (Application)

*4 The storage location which is stored an error code is as follows.

CC-Link IE Controller Network: SW0030 to SW0037

Ethernet: SW0030 to SW0037

MELSECNET/H: SW0031, SW0033, SW0035, SW0037, SW0039, SW003B, SW003D, SW003F

6.3 Reading Clock Data from the Programmable Controller on Another Station

J(P).RTMRD, G(P).RTMRD, Z(P).RTMRD

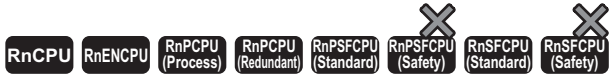

These instruction read clock data from the programmable controller on another station.

Ladder	ST
	<pre> ENO:=J_RTMRD(EN,J,s1,s2,s3,s4,d); ENO:=JP_RTMRD(EN,J,s1,s2,s3,s4,d); ENO:=G_RTMRD(EN,U,s1,s2,s3,s4,d); ENO:=GP_RTMRD(EN,U,s1,s2,s3,s4,d); ENO:=Z_RTMRD(EN,J/U,s1,s2,s3,s4,d); ENO:=ZP_RTMRD(EN,J/U,s1,s2,s3,s4,d); </pre>

FBD/LD

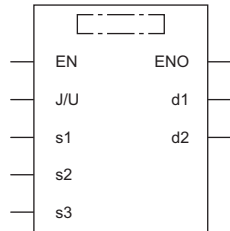

Execution condition

Instruction	Execution condition
J.RTMRD G.RTMRD Z.RTMRD	
JP.RTMRD GP.RTMRD ZP.RTMRD	

Setting data

■Description, range, data type

Operand		Description	Range	Data type	Data type (label)
(J/U)	J(P).RTMRD	(J): Target station network number	1 to 239	16-bit unsigned binary	ANY16
	G(P).RTMRD	(U): Start I/O number (first three digits in four-digit hexadecimal representation) of own station or own node	00H to FEH	16-bit unsigned binary	ANY16
	Z(P).RTMRD	(J): Target station network number	1 to 239	String	ANY16_OR_STRING_SINGLE
	Z(P).RTMRD	(U): Start I/O number (first three digits in four-digit hexadecimal representation) of own station or own node	00H to FEH	String	ANY16_OR_STRING_SINGLE
(s1)		Own station channel ( Page 66 Range of available channels)	—	16-bit unsigned binary	ANY16
(s2)		Target station number [Ethernet or CC-Link IE Controller Network] • 1 to 120 [MELSECNET/H] • 1 to 64	—	16-bit unsigned binary	ANY16
(s3)		Specify that CPU module in the target station that is to be accessed. • 0000H: Addressed to target station CPU (control CPU) • 03D0H: Addressed to control system CPU*1 • 03D1H: Addressed to standby system CPU*1 • 03D2H: Addressed to system A CPU • 03D3H: Addressed to system B CPU • 03E0H: Addressed to multiple CPU No. 1 • 03E1H: Addressed to multiple CPU No. 2 • 03E2H: Addressed to multiple CPU No. 3 • 03E3H: Addressed to multiple CPU No. 4 • 03FFH: Addressed to target station CPU (control CPU)	—	16-bit unsigned binary	ANY16
(d1)		Own station start device for storing the read clock data.	—	Device name	ANY16_ARRAY (Number of elements: 4)
(d2)		Device of the own station, which turns on for one scan upon completion of the instruction. When the instruction completes with an error, (d2)+1 also turns on.	—	Bit	ANYBIT_ARRAY (Number of elements: 2)
EN		Execution condition	—	Bit	BOOL
ENO		Execution result	—	Bit	BOOL

*1 If the instruction is executed with the control system CPU (03D0H) or standby system CPU (03D1H) specified, it may complete with an error if system switching occurs in the target station (error code: 4244H, 4248H).

Retry to execute the instruction if it completed with an error due to the above error.

■Applicable devices

Operand	Bit		Word			Double word		Indirect specification	Constant			Others	
	X, Y, M, L, SM, F, B, SB, FX, FY	J□□	T, ST, C, D, W, SD, SW, FD, R, ZR, RD	U□□G□, J□□, U3E□(H)G□	Z	LT, LST, LC	LZ		K, H	E	\$	J	U
(J/U)	J(P).RTMRD	—	—	—	—	—	—	—	—	—	—	—	—
	G(P).RTMRD	—	—	○	—	—	—	○	○	—	—	—	○
	Z(P).RTMRD	—	—	○	—	—	—	○	—	—	○	○	○
(s1)	○*1	—	○*2	—	—	—	○	○	—	—	—	—	
(s2)	○*1	—	○*2	—	—	—	○	○	—	—	—	—	
(s3)	○*1	—	○*2	—	—	—	○	○	—	—	—	—	
(d1)	—	—	○*2	—	—	—	○	○	—	—	—	—	
(d2)	○*1	—	○*3	—	—	—	—	—	—	—	—	—	

*1 FX and FY cannot be used.

*2 FD cannot be used.

*3 T, ST, C, and FD cannot be used.

■Clock data

Operand: (d1)				
Device	Item	Description	Setting range	Set by
+0	Clock data	Upper 8 bits: Year (00H to 99H: Upper two digits of the year) Lower 8 bits: Month (01H to 12H) The range of the 4 digits of the year is 1980 to 2079.	—	System
+1		Upper 8 bits: Day (01H to 31H) Lower 8 bits: Hour (00H to 23H)	—	System
+2		Upper 8 bits: Minute (00H to 59H) Lower 8 bits: Second (00H to 59H)	—	System
+3		Upper 8 bits: Year (19H and 20H: Upper two digits of the year) Lower 8 bits: Day of the week (00H (Sun.) to 06H (Sat.)) The range of the 4 digits of the year is 1980 to 2079.	—	System

Processing details

- Clock data is read from the target station CPU module. The target station is specified with the target network number (J) or the start I/O number (U) of the own station or node and the target station number (s2). After completion of request to the target station, the completion device specified by (d2) turns on.

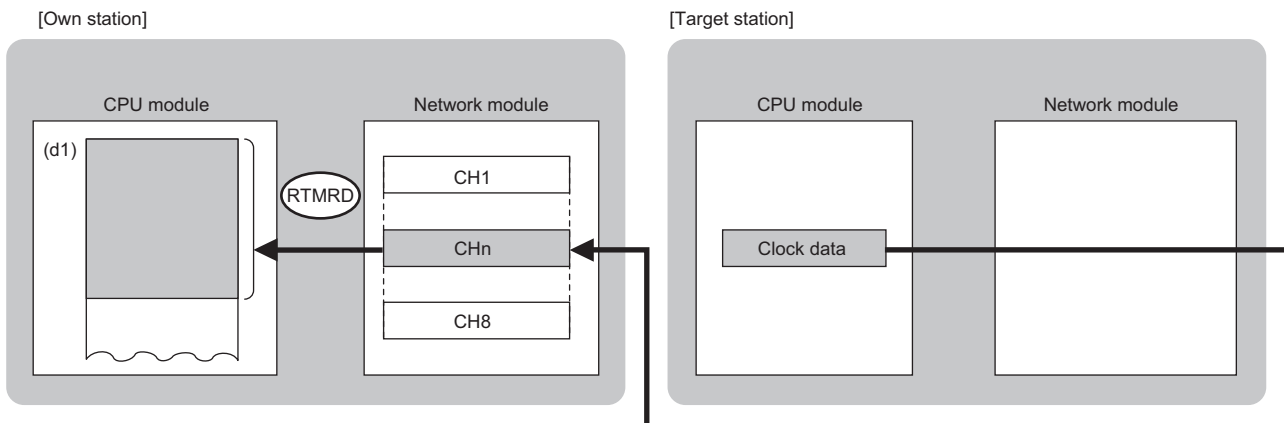

CH: Channel

- The specifiable stations are those with the specified network number that are included in one of the following networks.
 - MELSECNET/H
 - MELSECNET/10
 - CC-Link IE Controller Network
 - CC-Link IE Field Network
 - Ethernet
- The execution status and the completion status of the RTMRD instruction can be checked with the completion device (d2) and the completion status indication device (d2)+1.

- Completion device (d2)

This device turns on during END processing of the scan where the RTMRD instruction completes, and turns off during the next END processing.

- Completion status indication device (d2)+1

This device turns on or off depending on the completion status of the RTMRD instruction.

When completed successfully: The device remains off.

When completed with an error: The device turns on during END processing of the scan where the RTMRD instruction completes, and turns off during the next END processing.

• The following figure shows the RTMRD instruction execution timing.

• When completed successfully

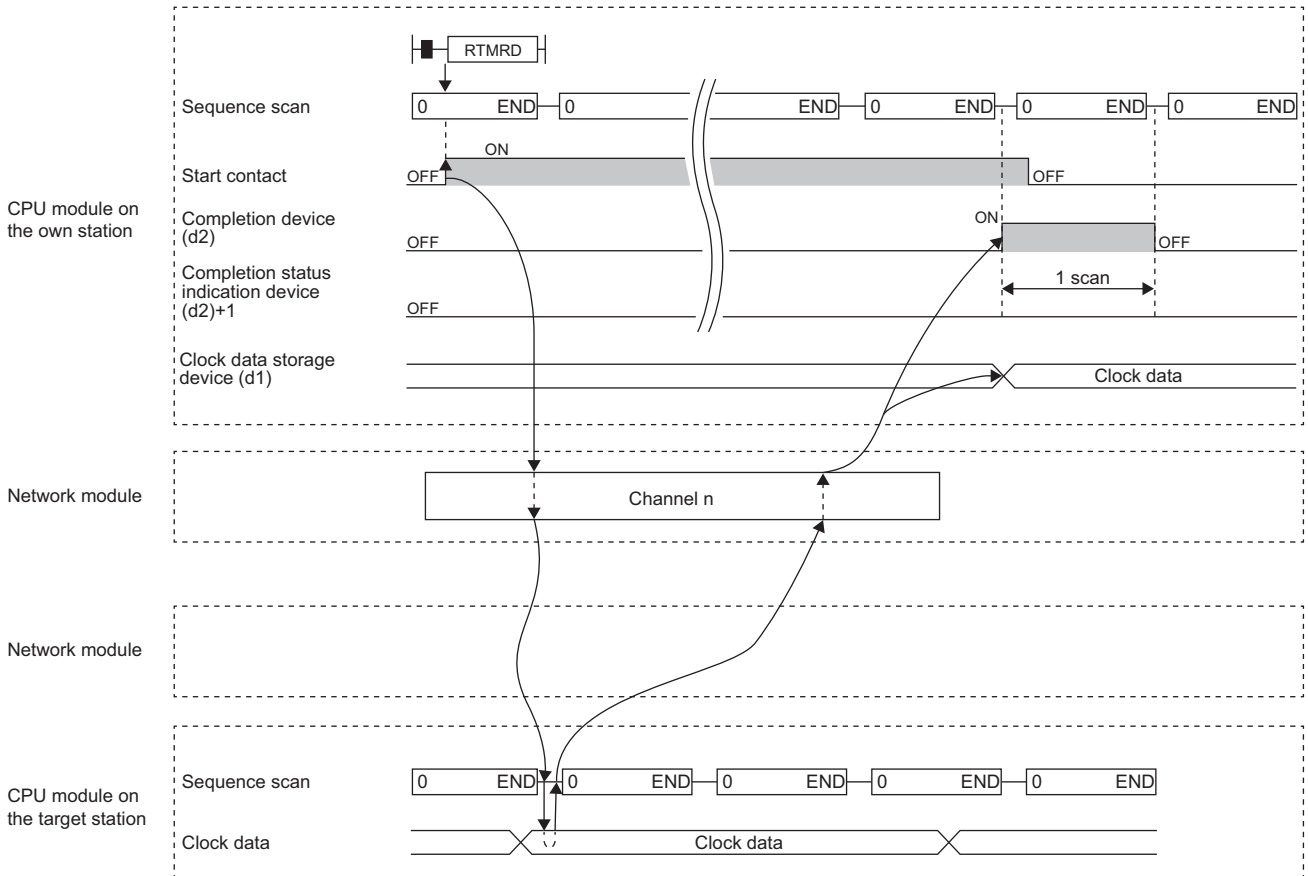



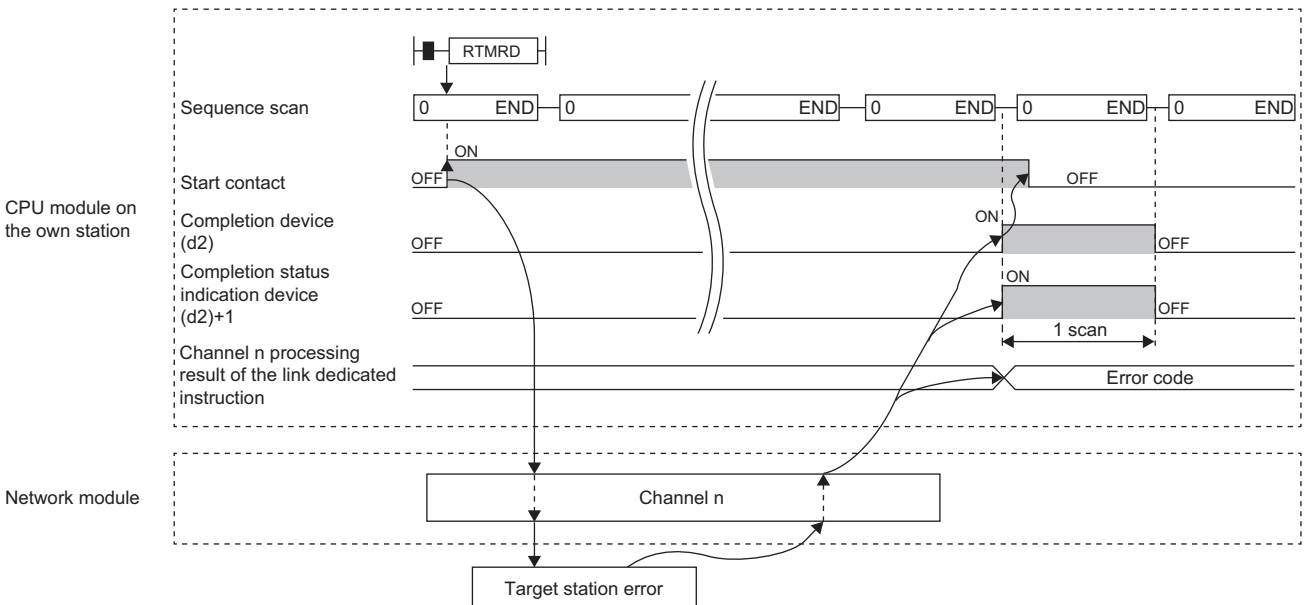

• When completed with an error



- If the J.RTMRD, G.RTMRD, or Z.RTMRD is used to execute processing, processing of one time is successively followed by the next processing while the start-up contact is on.
- If the JP.RTMRD, GP.RTMRD, or ZP.RTMRD is used to execute processing, processing is executed once at the start-up contact off-to-on rise.

Operation error

Error code (SW0030 to SW0037)	Description
4000H to 4FFFH	 MELSEC iQ-R CPU Module User's Manual (Application)
6F00H to 6FFFH	 MELSEC iQ-R CPU Module User's Manual (Application)
E000H to EFFFH	 MELSEC iQ-R CC-Link IE Controller Network User's Manual (Application)
F000H to FFFFH	 MELSEC iQ-R MELSECNET/H Network Module User's Manual (Application)

6.4 Writing Clock Data to the Programmable Controller on Another Station

J(P).RTMWR, G(P).RTMWR, Z(P).RTMWR

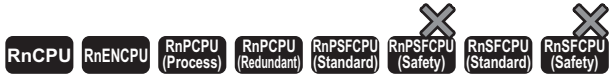

These instruction write clock data to the programmable controller on another station.

Ladder	ST
	<pre> ENO:=J_RTMWR(EN,J,s1,s2,s3,s4,d); ENO:=JP_RTMWR(EN,J,s1,s2,s3,s4,d); ENO:=G_RTMWR(EN,U,s1,s2,s3,s4,d); ENO:=GP_RTMWR(EN,U,s1,s2,s3,s4,d); ENO:=Z_RTMWR(EN,J/U,s1,s2,s3,s4,d); ENO:=ZP_RTMWR(EN,J/U,s1,s2,s3,s4,d); </pre>

FBD/LD

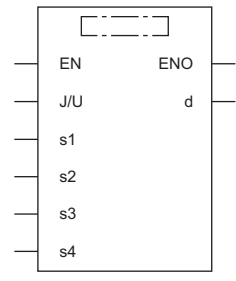

■ Execution condition

Instruction	Execution condition
J.RTMWR G.RTMWR Z.RTMWR	
JP.RTMWR GP.RTMWR ZP.RTMWR	

Setting data

■Description, range, data type

Operand	Description	Range	Data type	Data type (label)	
(J/U)	J(P).RTMWR	(J): Target station network number	1 to 239	16-bit unsigned binary	ANY16
	G(P).RTMWR	(U): Start I/O number (first three digits in four-digit hexadecimal representation) of own station or own node	00H to FEH	16-bit unsigned binary	ANY16
	Z(P).RTMWR	(J): Target station network number	1 to 239	String	ANY16_OR_STRING_SINGLE
	Z(P).RTMWR	(U): Start I/O number (first three digits in four-digit hexadecimal representation) of own station or own node	00H to FEH	String	ANY16_OR_STRING_SINGLE
(s1)	Own station channel (☞ Page 66 Range of available channels)	—	16-bit unsigned binary	ANY16	
(s2)	Specify the station number of the target station/target node. (1) Station number specification [Ethernet or CC-Link IE Controller Network] • 1 to 120 [MELSECNET/H] • 1 to 64 (2) Group specification* ¹ 81H to A0H: All stations of group numbers 1 to 32 (3) All-station specification* ¹ FFH: All stations of target network numbers, except own station	—	16-bit unsigned binary	ANY16	
(s3)	Specify that CPU module in the target station that is to be accessed. • 0000H: Addressed to target station CPU (control CPU) • 03D0H: Addressed to control system CPU* ² • 03D1H: Addressed to standby system CPU* ² • 03D2H: Addressed to system A CPU • 03D3H: Addressed to system B CPU • 03E0H: Addressed to multiple CPU No. 1 • 03E1H: Addressed to multiple CPU No. 2 • 03E2H: Addressed to multiple CPU No. 3 • 03E3H: Addressed to multiple CPU No. 4 • 03FFH: Addressed to target station CPU (control CPU)	—	16-bit unsigned binary	ANY16	
(s4)	Own station start device where the clock data to be written is stored	—	Device name	ANY16_ARRAY (Number of elements: 5)	
(d)	Device of the own station, which turns on for one scan upon completion of the instruction. When the instruction completes with an error, (d)+1 also turns on.	—	Bit	ANYBIT_ARRAY (Number of elements: 2)	
EN	Execution condition	—	Bit	BOOL	
ENO	Execution result	—	Bit	BOOL	

*1 If the instruction is executed with group or all stations specification:

For the target station CPU type (s3), specify either 0000H or 03FFH. If the target station is in CC-Link IE Field Network, group specification is not available. To check that the data has been written successfully in the target station, examine whether the clock data has reflected to the CPU module of the destination.

*2 If the instruction is executed with the control system CPU (03D0H) or standby system CPU (03D1H) specified, it may complete with an error if system switching occurs in the target station (error code: 4244H, 4248H).

Retry to execute the instruction if it completed with an error due to the above error.

■Applicable devices

Operand	Bit		Word			Double word		Indirect specification	Constant			Others	
	X, Y, M, L, SM, F, B, SB, FX, FY	J□□□	T, ST, C, D, W, SD, SW, FD, R, ZR, RD	U□□G□, J□□□, U3E□(H)G□	Z	LT, LST, LC	LZ		K, H, E, \$	J, U			
(J/U)	J(P).RTMWR	—	—	—	—	—	—	—	—	—	—	—	—
	G(P).RTMWR	—	—	○	—	—	—	○	○	—	—	—	○
	Z(P).RTMWR	—	—	○	—	—	—	○	—	—	○	○	○
(s1)		○*1	—	○*2	—	—	—	○	○	—	—	—	—
(s2)		○*1	—	○*2	—	—	—	○	○	—	—	—	—
(s3)		○*1	—	○*2	—	—	—	○	○	—	—	—	—
(s4)		—	—	○*2	—	—	—	○	○	—	—	—	—
(d)		○*1	—	○*3	—	—	—	—	—	—	—	—	—

- *1 FX and FY cannot be used.
- *2 FD cannot be used.
- *3 T, ST, C, and FD cannot be used.

■Clock data

Operand: (s4)				
Device	Item	Description	Setting range	Set by
+0	Change pattern	Specifies the bit pattern that indicates the item of the clock data to be changed. <ul style="list-style-type: none"> • 0: Not changed • 1: Changed b15 ... b8 b7 b6 b5 b4 b3 b2 b1 b0 <div style="border: 1px solid black; width: 100%; height: 15px; margin: 5px 0;"></div> b7: Year (first two digits), b6: Day of week, b5: Second, b4: Minute, b3: Hour, b2: Day, b1: Month, b0: Year (last two digits)	0, 1	User
+1	Clock data	Upper 8 bits: Year (00H to 99H: Upper two digits of the year) Lower 8 bits: Month (01H to 12H) The range of the 4 digits of the year is 1980 to 2079.	Year: 00H to 99H Month: 01H to 12H	User
+2		Upper 8 bits: Day (01H to 31H) Lower 8 bits: Hour (00H to 23H)	Day: 01H to 31H Hour: 00H to 23H	User
+3		Upper 8 bits: Minute (00H to 59H) Lower 8 bits: Second (00H to 59H)	Minute: 00H to 59H Second: 00H to 59H	User
+4		Upper 8 bits: Year (19H and 20H: Upper two digits of the year) Lower 8 bits: Day of the week (00H (Sun.) to 06H (Sat.)) The range of the 4 digits of the year is 1980 to 2079.	Year: 19H to 20H Day of week: 00H to 06H	User



If the target station CPU module is system protected, writing the clock data will fail.

Processing details

- Clock data is written from the target station CPU module. The target station is specified with the target network number (J) or the start I/O number (U) of the own station or node and the target station number (s2). After completion of request to the target station, the completion device specified by (d) turns on.

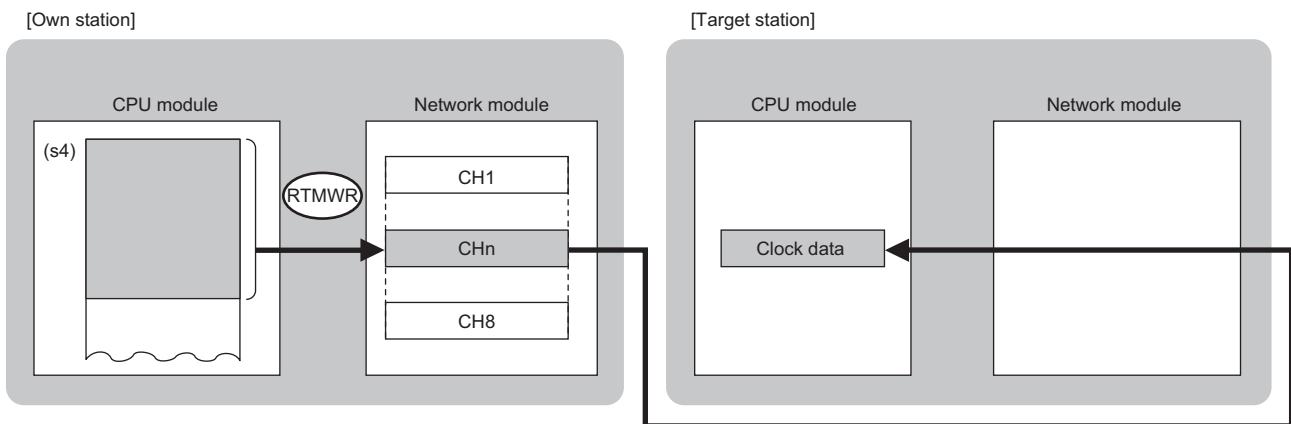

CH: Channel

- The specifiable stations are those with the specified network number that are included in one of the following networks.
 - MELSECNET/H
 - MELSECNET/10
 - CC-Link IE Controller Network
 - CC-Link IE Field Network
 - Ethernet
- The execution status and the completion status of the RTMWR instruction can be checked with the completion device (d) and the completion status indication device (d)+1.

- Completion device (d)

This device turns on during END processing of the scan where the RTMWR instruction completes, and turns off during the next END processing.

- Completion status indication device (d)+1

This device turns on or off depending on the completion status of the RTMWR instruction.

When completed successfully: The device remains off.

When completed with an error: The device turns on during END processing of the scan where the RTMWR instruction completes, and turns off during the next END processing.

- The following figure shows the RTMWR instruction execution timing.
- When completed successfully

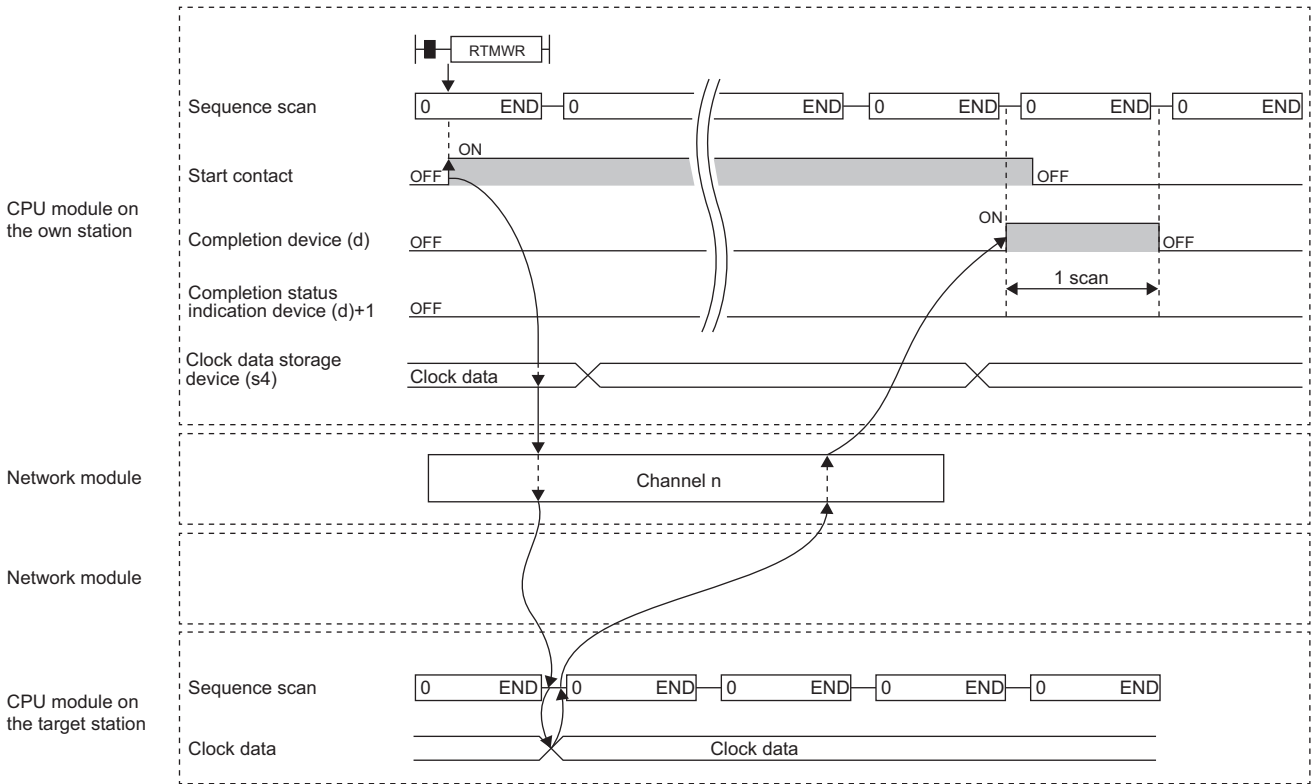



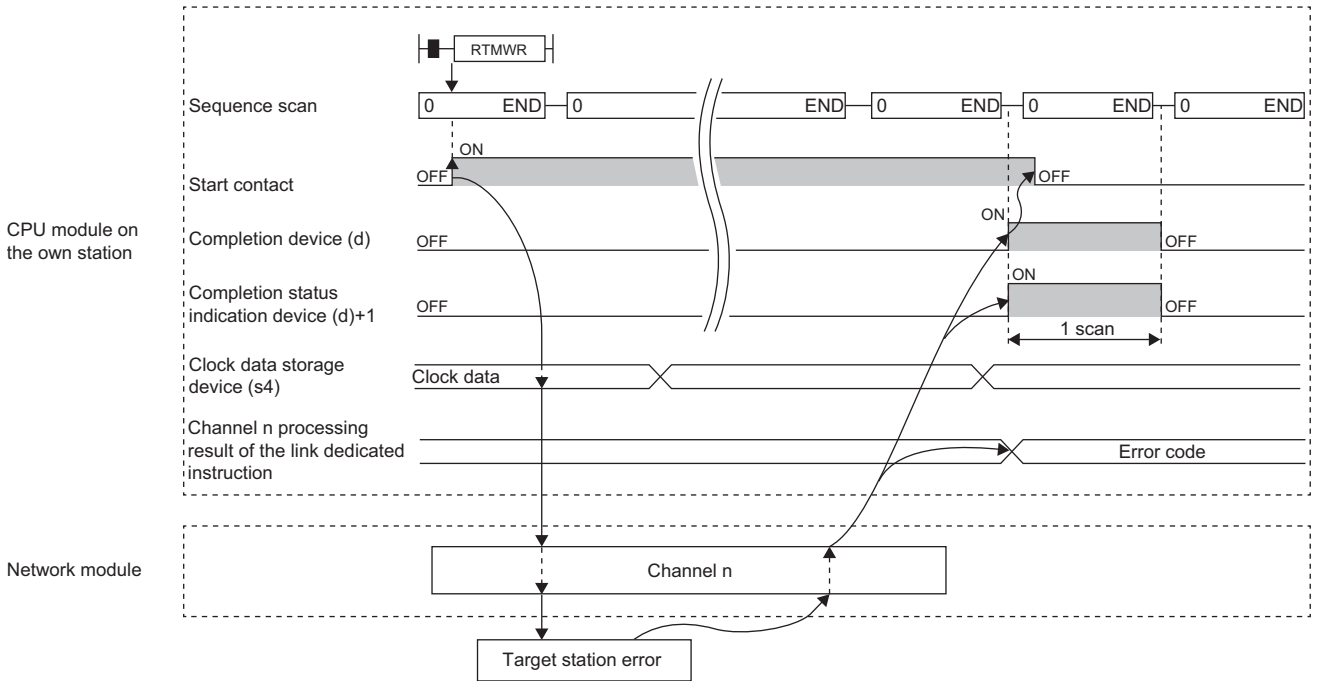

- When completed with an error



- If the J.RTMWR, G.RTMWR, or Z.RTMWR is used to execute processing, processing of one time is successively followed by the next processing while the start-up contact is on.
- If the JP.RTMWR, GP.RTMWR, or ZP.RTMWR is used to execute processing, processing is executed once at the start-up contact off-to-on rise.

Operation error

Error code (SW0030 to SW0037)	Description
4000H to 4FFFH	 MELSEC iQ-R CPU Module User's Manual (Application)
6F00H to 6FFFH	 MELSEC iQ-R CPU Module User's Manual (Application)
E000H to EFFFH	 MELSEC iQ-R CC-Link IE Controller Network User's Manual (Application)
F000H to FFFFH	 MELSEC iQ-R MELSECNET/H Network Module User's Manual (Application)

6.5 Setting the Station Number to Own Station

G(P).UINI, Z(P).UINI



These instructions set the station number for the normal, or own, station whose station number has not yet been set.

Ladder	ST
	<pre> ENO:=G_UINI(EN,U,s,d); ENO:=GP_UINI(EN,U,s,d); ENO:=Z_UINI(EN,U,s,d); ENO:=ZP_UINI(EN,U,s,d); </pre>

FBD/LD

Execution condition

Instruction	Execution condition
G.UINI Z.UINI	
GP.UINI ZP.UINI	

Setting data

Description, range, data type

Operand	Description	Range	Data type	Data type (label)	
(U)	G(P).UINI	Start I/O number (first three digits in four-digit hexadecimal representation) of own station or own node	00H to FEH	16-bit unsigned binary	ANY16
	Z(P).UINI	Start I/O number (first three digits in four-digit hexadecimal representation) of own station or own node	00H to FEH	String	ANY16_OR_STRING_SINGLE
(s)	Own station start device where control data is stored	Refer to the control data.	Device name	ANY16 ^{*1}	
(d)	Device of the own station, which turns on for one scan upon completion of the instruction. When the instruction completes with an error, (d)+1 also turns on.	—	Bit	ANYBIT_ARRAY (Number of elements: 2)	
EN	Execution condition	—	Bit	BOOL	
ENO	Execution result	—	Bit	BOOL	

*1 When specifying setting data by using a label, define an array to secure enough operation area and specify an element of the array label.

■Applicable devices

Operand		Bit		Word			Double word		Indirect specification	Constant			Others (U)
		X, Y, M, L, SM, F, B, SB, FX, FY	J□\□	T, ST, C, D, W, SD, SW, FD, R, ZR, RD	U□\G□, J□\□, U3E□\□(H)G□	Z	LT, LST, LC	LZ		K, H	E	\$	
(U)	G(P).UINI	—	—	○	—	—	—	—	○	○	—	—	○
	Z(P).UINI	—	—	○	—	—	—	—	○	—	—	○	○
(s)		—	—	○*2	—	—	—	—	○	—	—	—	—
(d)		○*1	—	○*3	—	—	—	—	—	—	—	—	—

*1 FX and FY cannot be used.

*2 FD cannot be used.

*3 T, ST, C, and FD cannot be used.

■Control data

Operand: (s)				
Device	Item	Description	Setting range	Set by
+0	Not used	—	—	—
+1	Completion status	The instruction completion status is stored. • 0: Normal • Other than 0: Error (error code)	—	System
+2	Change target specification	0001H (fixed)	0001H	User
+3	Station number of own station	Specifies the station number to be set.	1 to 120	User
+4 to +9	Not used	—	—	—

Point

- The UINI instruction can be executed only once.
- If the UINI instruction is issued after the station number has been determined, it will complete with an error.
- If the UINI instruction completes with an error before the station number is determined, take corrective action to correct the error content before retrying to execute the instruction.

Processing details

- The station number of the normal, or own, station specified by (U) is set. After station number setting, the completion device specified by (d) turns on.

[Own station]

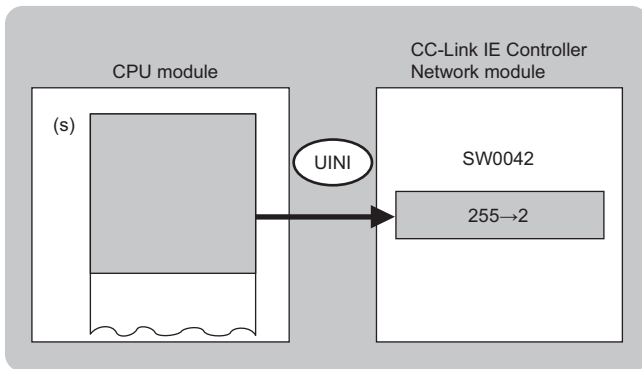

- The execution status and the completion status of the UINI instruction can be checked with the completion device (d) and the completion status indication device (d)+1.

- Completion device (d)

This device turns on during END processing of the scan where the UINI instruction completes, and turns off during the next END processing.

- Completion status indication device (d)+1

This device turns on or off depending on the completion status of the UINI instruction.

When completed successfully: The device remains off.

When completed with an error: The device turns on during END processing of the scan where the UINI instruction completes, and turns off during the next END processing.

- The following figure shows the UINI instruction execution timing.

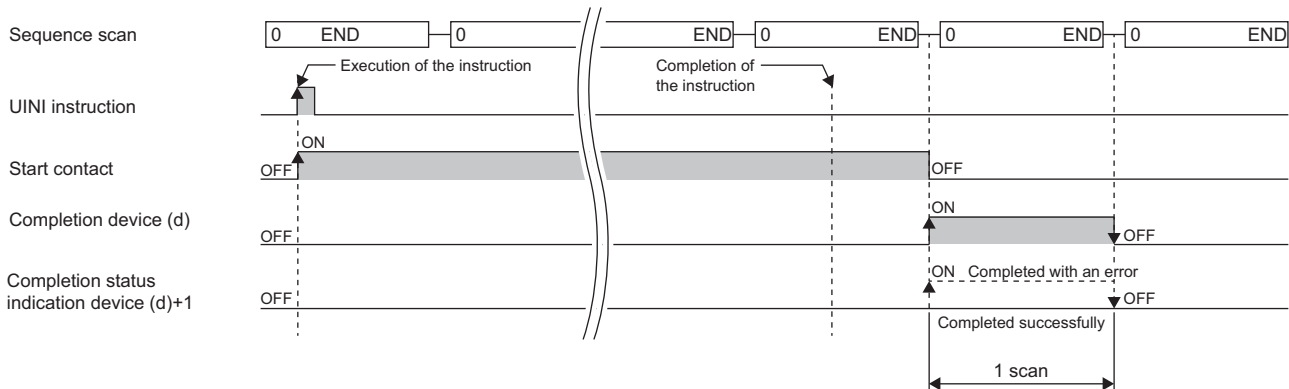

Operation error

Error code ((S)+1)	Description
E000H to EFFFH	MELSEC iQ-R CC-Link IE Controller Network User's Manual (Application)

7 CC-Link IE Field Network INSTRUCTIONS

Point

This chapter describes the instructions used commonly by MELSEC iQ-R series modules. For the instructions when MELSEC-Q series modules are used, refer to the manuals for each module used and create programs. For precautions when using modules, refer to the following.

MELSEC iQ-R Module Configuration Manual

7.1 Reading Data from the Intelligent Device Station/ Remote Device Station (16-bit Address Specified)

JP.REMFR, ZP.REMFR



These instructions read data from the buffer memory area of the intelligent device station or the remote device station (in units of words, 16-bit address specified).

Ladder	ST
	ENO:=JP_REMFR(EN,J,s1,s2,s3,s4,n,d1,d2); ENO:=ZP_REMFR(EN,J,s1,s2,s3,s4,n,d1,d2);

FBD/LD

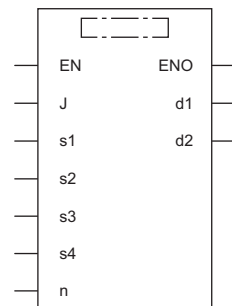

Execution condition

Instruction	Execution condition
JP.REMFR ZP.REMFR	

Setting data

■Description, range, data type

Operand		Description	Range	Data type	Data type (label)
(J)	JP.REMFR	Target network number	1 to 239	16-bit unsigned binary	ANY16
	ZP.REMFR	Target network number	1 to 239	String	ANY16_OR_STRING_SINGLE
(s1)		Channel of the own station, which is used for the instruction ^{*1}	1 to 32	16-bit unsigned binary	ANY16
(s2)		Target station number	1 to 120	16-bit unsigned binary	ANY16
(s3)		Start I/O number of target station	■Head module: 00H to FEH ^{*2} ■Modules other than the head module: 00H (fixed)	16-bit unsigned binary	ANY16
(s4)		Start address of the buffer memory area of the intelligent device station or the remote device station where the read-target data is stored	0000H to FFFFH (0 to 65535)	16-bit unsigned binary	ANY16
(d1)		Start device of the own station for storing the read data	—	Device name	ANY16 ^{*3}
(n)		Number of read data points (in units of words)	1 to 240	16-bit unsigned binary	ANY16
(d2)		Device of the own station, which turns on for one scan upon completion of the instruction. When the instruction completes with an error, (d2)+1 also turns on.	—	Bit	ANYBIT_ARRAY (Number of elements: 2)
EN		Execution condition	—	Bit	BOOL
ENO		Execution result	—	Bit	BOOL

*1 A channel is used only for the REMFR, REMTO, REMFRD, and REMTOD instructions.

The same channel number used for the link dedicated instructions (such as the READ instruction) can be set.

*2 This is the start I/O number (first three digits in four-digit hexadecimal representation) of intelligent function modules.

*3 When specifying setting data by using a label, define an array to secure enough operation area and specify an element of the array label.



Use the REMFRD instruction if the start address of the buffer memory area (s4) exceeds FFFFH (65535).

■Applicable devices

Operand	Bit X, Y, M, L, SM, F, B, SB, FX, FY	Word J□□□	Word T, ST, C, D, W, SD, SW, FD, R, ZR, RD	U□\G□, J□□□, U3E□\(\H)G□	Z	Double word		Indirect specification	Constant			Others (J)
						LT, LST, LC	LZ		K, H	E	\$	
(J)	JP.REMFR	—	—	—	—	—	—	—	—	—	—	○
	ZP.REMFR	—	—	—	—	—	—	—	—	—	○	○
(s1)	○ ^{*1}	—	○ ^{*2}	—	—	—	—	○	○	—	—	—
(s2)	○ ^{*1}	—	○ ^{*2}	—	—	—	—	○	○	—	—	—
(s3)	○ ^{*1}	—	○ ^{*2}	—	—	—	—	○	○	—	—	—
(s4)	○ ^{*1}	—	○ ^{*2}	—	—	—	—	○	○	—	—	—
(d1)	—	—	○ ^{*2}	—	—	—	—	○	—	—	—	—
(n)	○ ^{*1}	—	○ ^{*2}	—	—	—	—	○	○	—	—	—
(d2)	○ ^{*1}	—	○ ^{*3}	—	—	—	—	—	—	—	—	—

*1 FX and FY cannot be used.

*2 FD cannot be used.

*3 T, ST, C, and FD cannot be used.

Processing details

- These instructions read the data from the start address (s4) of the buffer memory area of the intelligent device station or the remote device station to the word device ((d1) and later) of the own station for the specified number of words (n). Specify the target station by using (J), (s2), and (s3). The completion device (d2) turns on upon completion of the instruction.

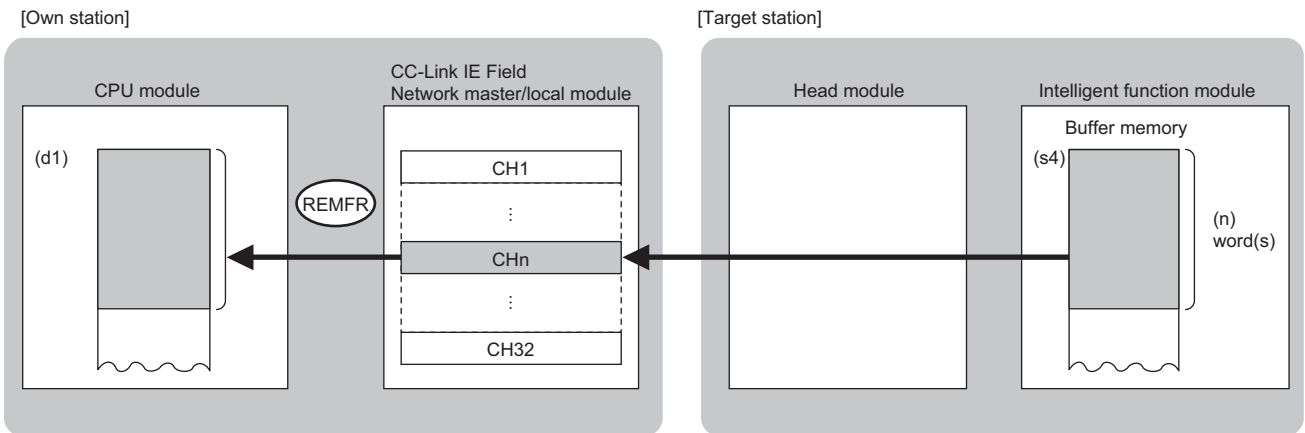

CH: Channel

- The execution status and the completion status of the REMFR instruction can be checked with the completion device (d2) and the completion status indication device (d2)+1.

- Completion device (d2)

This device turns on during END processing of the scan where the REMFR instruction completes, and turns off during the next END processing.

- Completion status indication device (d2)+1

This device turns on or off depending on the completion status of the REMFR instruction.

When completed successfully: The device remains off.

When completed with an error: The device turns on during END processing of the scan where the REMFR instruction completes, and turns off during the next END processing.

- The following figure shows the operation at completion of the REMFR instruction.
- When completed successfully

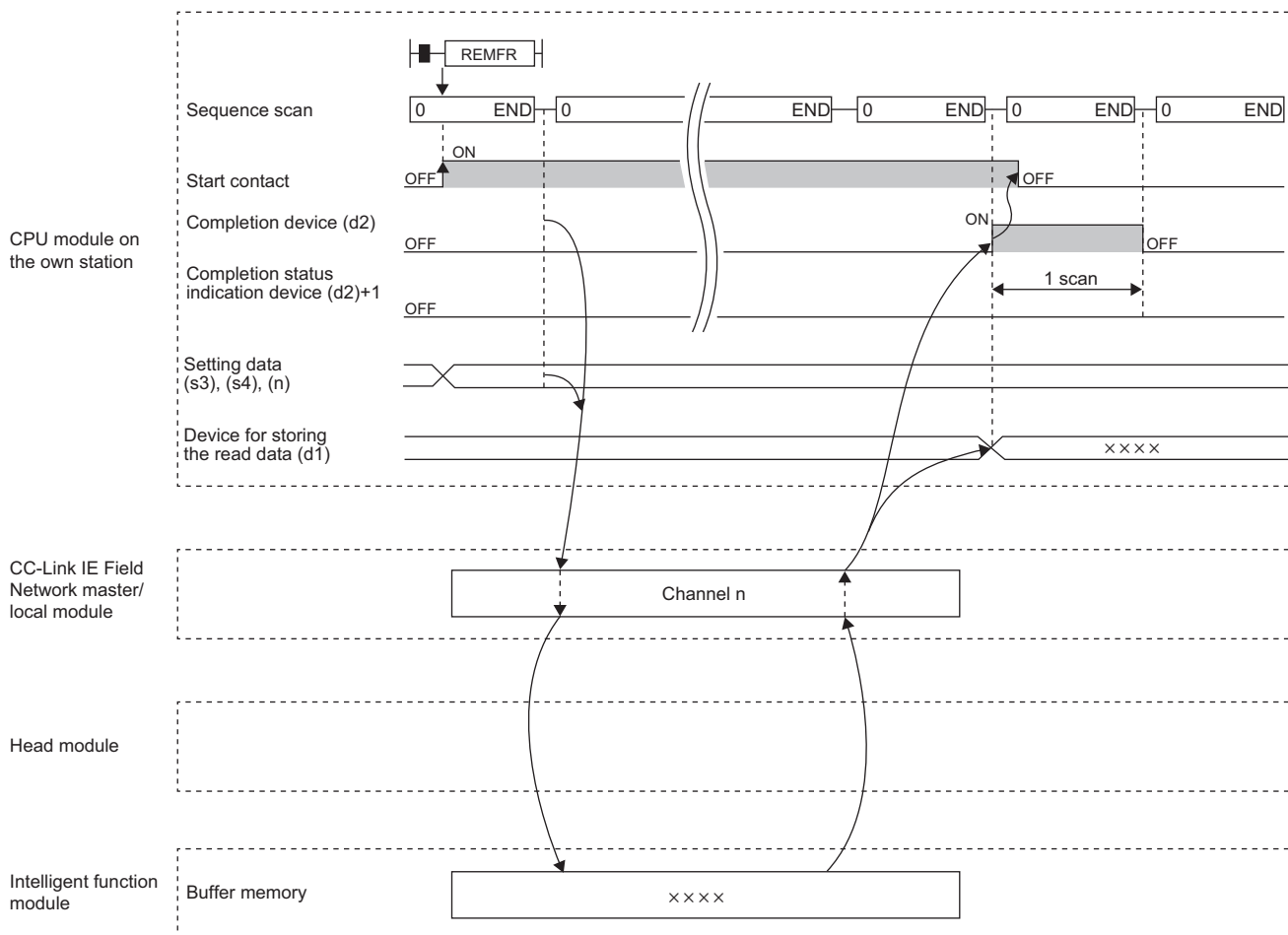

- When completed with an error

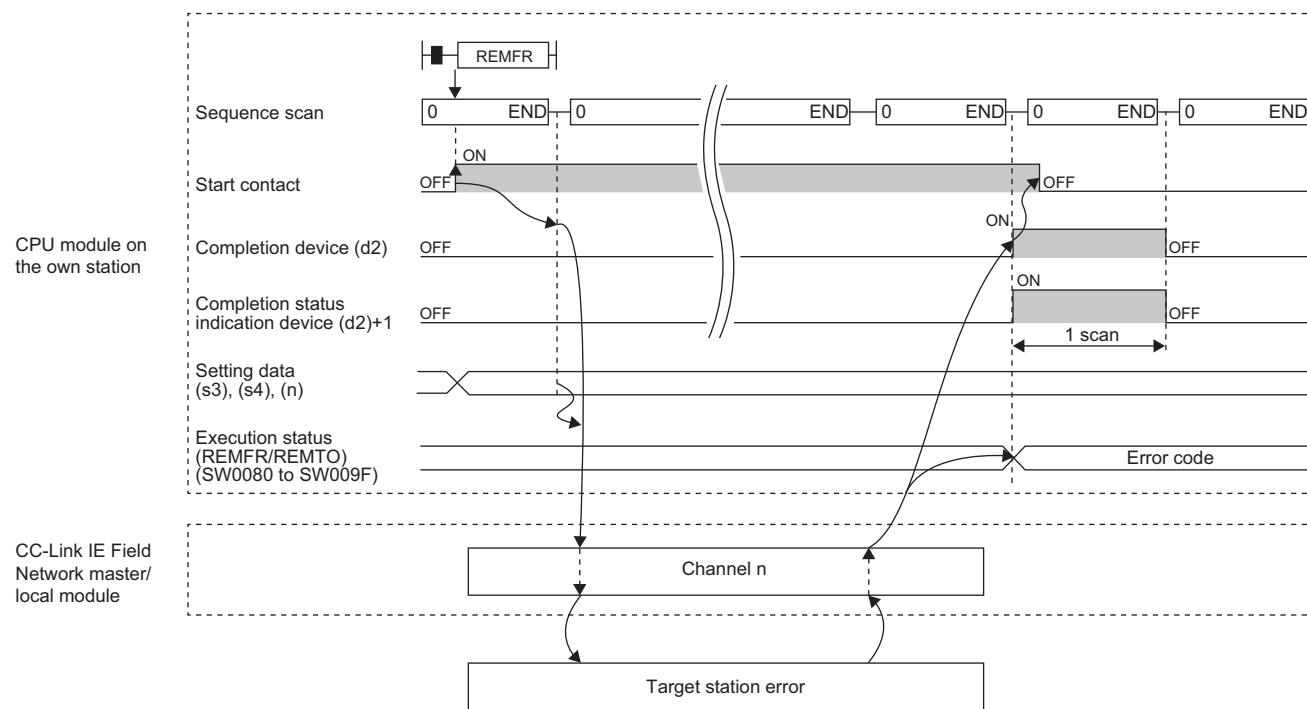

Point

For the REMFR instruction, the number of resends and the response wait timer can be set in the following link special register (SW) areas.



- Number of resends (REMFR/REMTO) (SW001A)
- Response wait timer (REMFR/REMTO) (SW001B)

If the number of resends (REMFR/REMTO) (SW001A) is set, the REMFR instruction completes with an error after the following time has elapsed:

(Number of resends (REMFR/REMTO) + 1) × Response wait timer (REMFR/REMTO)

Note, however, that no retry is performed if the target station is disconnected. If the REMFR instruction completes with an error, execute the instruction again after the target station returns to the system.

Operation error

Error code (SW0080 to SW009F)	Description
4000H to 4FFFH	 MELSEC iQ-R CPU Module User's Manual (Application)
D000H to DFFFH	 MELSEC iQ-R CC-Link IE Field Network User's Manual (Application)

7.2 Writing Data to the Intelligent Device Station/ Remote Device Station (16-bit Address Specified)

JP.REMTO, ZP.REMTO

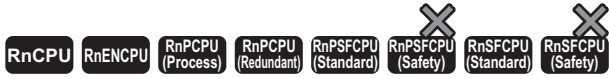

These instructions write data to the buffer memory area of the intelligent device station or the remote device station (in units of words, 16-bit address specified).

Ladder	ST
	<pre>ENO:=JP_REMTO(EN,J,s1,s2,s3,s4,s5,n,d); ENO:=ZP_REMTO(EN,J,s1,s2,s3,s4,s5,n,d);</pre>

FBD/LD

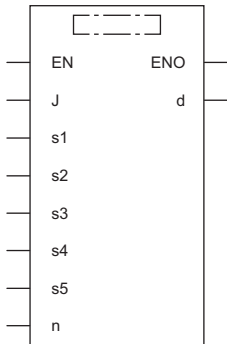

Execution condition

Instruction	Execution condition
JP.REMTO ZP.REMTO	

Setting data

■Description, range, data type

Operand		Description	Range	Data type	Data type (label)
(J)	JP.REMTO	Target network number	1 to 239	16-bit unsigned binary	ANY16
	ZP.REMTO	Target network number	1 to 239	String	ANY16_OR_STRING_SINGLE
(s1)		Channel of the own station, which is used for the instruction ^{*1}	1 to 32	16-bit unsigned binary	ANY16
(s2)		Target station number	1 to 120	16-bit unsigned binary	ANY16
(s3)		Start I/O number of target station	■Head module: 00H to FEH ^{*2} ■Modules other than the head module: 00H (fixed)	16-bit unsigned binary	ANY16
(s4)		Start address of the buffer memory area of the intelligent device station or the remote device station where the data is written	0000H to FFFFH (0 to 65535)	16-bit unsigned binary	ANY16
(s5)		Start device of the own station, where the write-target data is stored	—	Device name	ANY16 ^{*3}
(n)		Number of write data points (in units of words)	1 to 240	16-bit unsigned binary	ANY16
(d)		Device of the own station, which turns on for one scan upon completion of the instruction. When the instruction completes with an error, (d)+1 also turns on.	—	Bit	ANYBIT_ARRAY (Number of elements: 2)
EN		Execution condition	—	Bit	BOOL
ENO		Execution result	—	Bit	BOOL

*1 A channel is used only for the REMFR, REMTO, REMFRD, and REMTOD instructions.

The same channel number used for the link dedicated instructions (such as the READ instruction) can be set.

*2 This is the start I/O number (first three digits in four-digit hexadecimal representation) of intelligent function modules.

*3 When specifying setting data by using a label, define an array to secure enough operation area and specify an element of the array label.



Use the REMTOD instruction if the start address of the buffer memory area (s4) exceeds FFFFH (65535).

■Applicable devices

Operand	Bit X, Y, M, L, SM, F, B, SB, FX, FY	J□□□	Word				Double word			Indirect specification	Constant			Others (J)
			T, ST, C, D, W, SD, SW, FD, R, ZR, RD	U□\G□, J□□□, U3E□\□(H)G□	Z	LT, LST, LC	LZ	K, H	E		\$			
(J)	JP.REMTO	—	—	—	—	—	—	—	—	—	—	—	—	○
	ZP.REMTO	—	—	—	—	—	—	—	—	—	—	—	○	○
(s1)	○ ^{*1}	—	○ ^{*2}	—	—	—	—	○	○	○	—	—	—	—
(s2)	○ ^{*1}	—	○ ^{*2}	—	—	—	—	○	○	○	—	—	—	—
(s3)	○ ^{*1}	—	○ ^{*2}	—	—	—	—	○	○	○	—	—	—	—
(s4)	○ ^{*1}	—	○ ^{*2}	—	—	—	—	○	○	○	—	—	—	—
(s5)	—	—	○ ^{*2}	—	—	—	—	○	—	—	—	—	—	—
(n)	○ ^{*1}	—	○ ^{*2}	—	—	—	—	○	○	○	—	—	—	—
(d)	○ ^{*1}	—	○ ^{*3}	—	—	—	—	—	—	—	—	—	—	—

*1 FX and FY cannot be used.

*2 FD cannot be used.

*3 T, ST, C, and FD cannot be used.

Processing details

- These instructions write the data from the start device (s5) of the own station to the buffer memory area ((s4) and later) of the intelligent device station or the remote device station for the specified number of words (n). Specify the target station by using (J), (s2), and (s3). The completion device (d) turns on upon completion of the instruction.

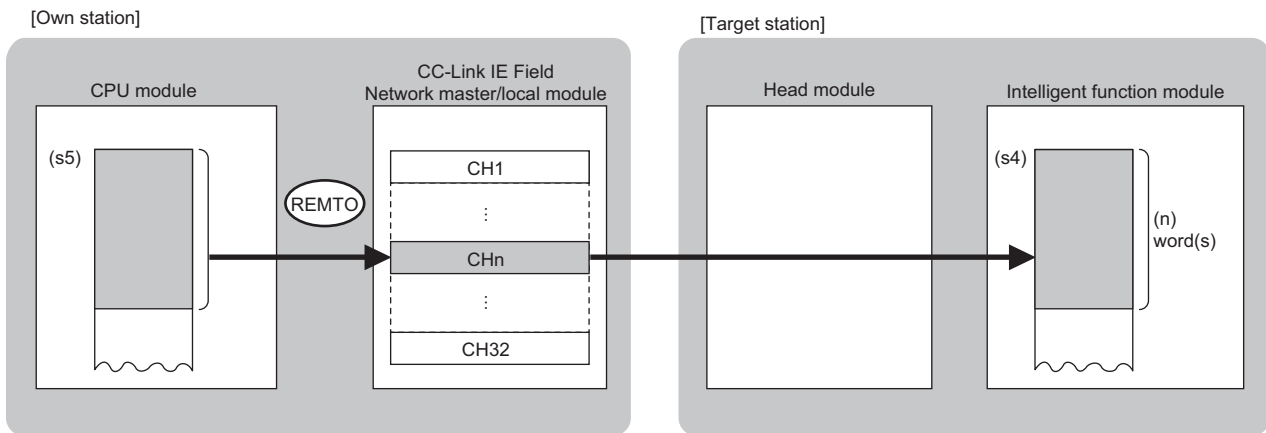

CH: Channel

- The execution status and the completion status of the REMTO instruction can be checked with the completion device (d) and the completion status indication device (d)+1.

- Completion device (d)

This device turns on during END processing of the scan where the REMTO instruction completes, and turns off during the next END processing.

- Completion status indication device (d)+1

This device turns on or off depending on the completion status of the REMTO instruction.

When completed successfully: The device remains off.

When completed with an error: The device turns on during END processing of the scan where the REMTO instruction completes, and turns off during the next END processing.

- The following figure shows the operation at completion of the REMTO instruction.
- When completed successfully

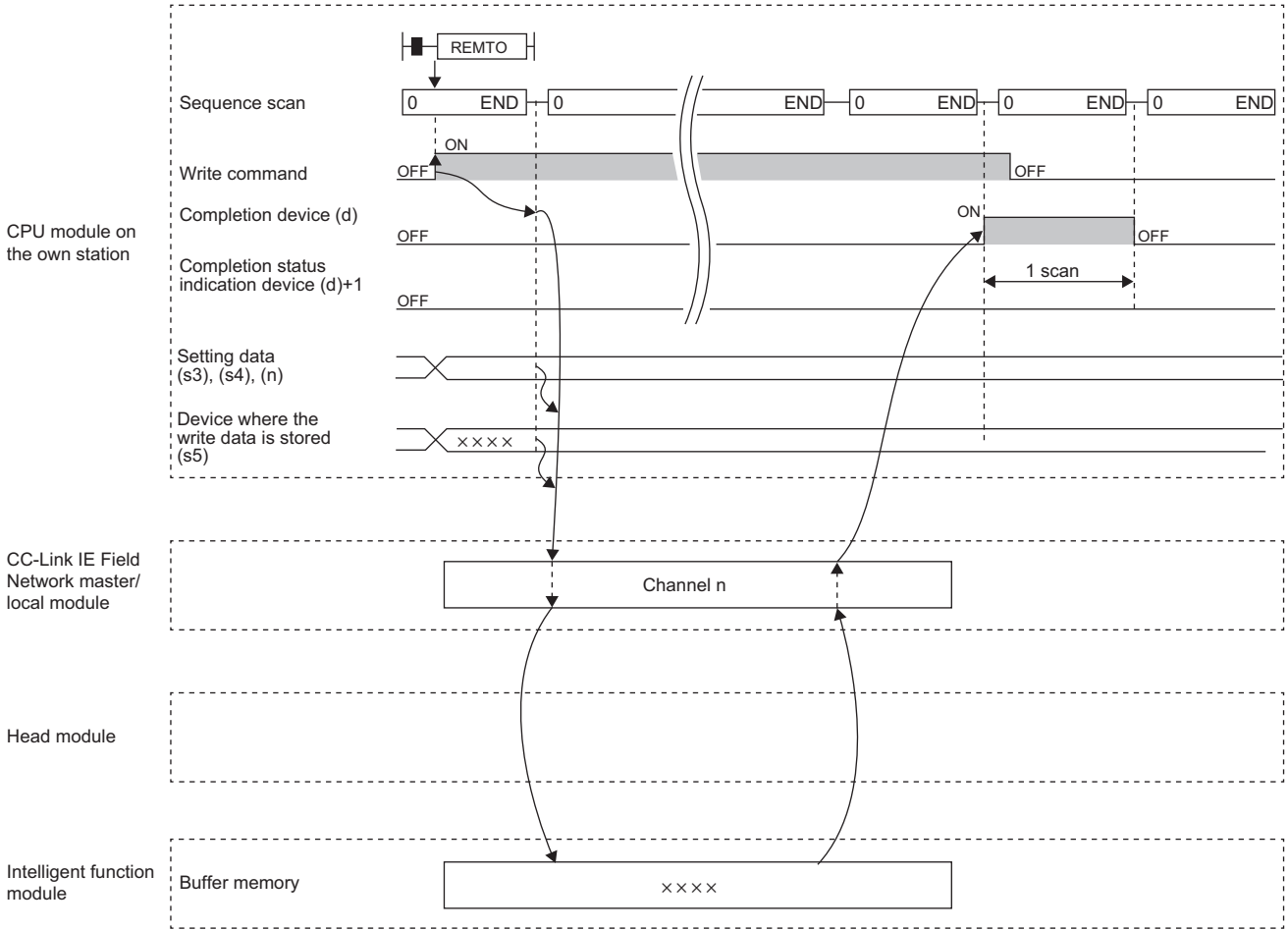

- When completed with an error

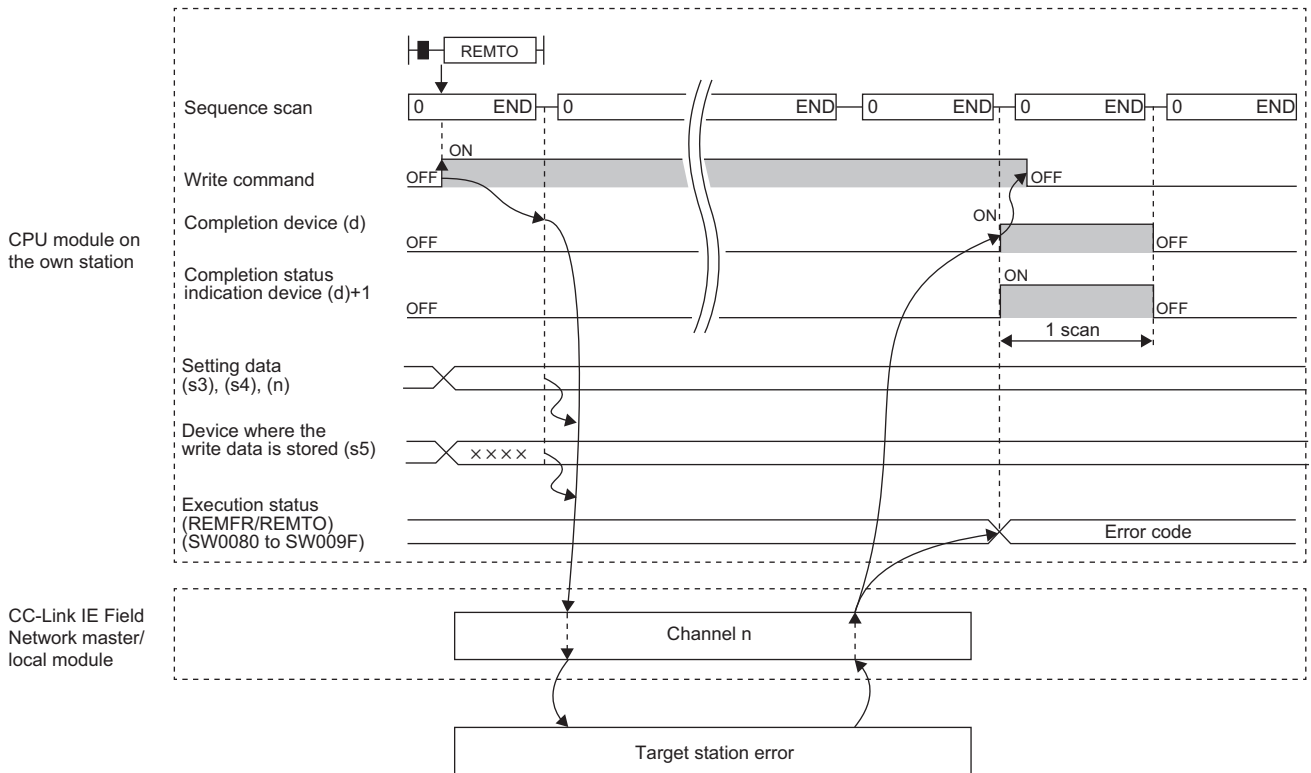

Point 

For the REMTO instruction, the number of resends and the response wait timer can be set in the following link special register (SW) areas.



- Number of resends (REMFR/REMTO) (SW001A)
- Response wait timer (REMFR/REMTO) (SW001B)

If the number of resends (REMFR/REMTO) (SW001A) is set, the REMTO instruction completes with an error after the following time has elapsed:

(Number of resends (REMFR/REMTO) + 1) × Response wait timer (REMFR/REMTO)

Note, however, that no retry is performed if the target station is disconnected. If the REMTO instruction completes with an error, execute the instruction again after the target station returns to the system.

Operation error

Error code (SW0080 to SW009F)	Description
4000H to 4FFFH	 MELSEC iQ-R CPU Module User's Manual (Application)
D000H to DFFFH	 MELSEC iQ-R CC-Link IE Field Network User's Manual (Application)

7.3 Reading Data from the Intelligent Device Station/ Remote Device Station (32-bit Address Specified)

JP.REMFRD

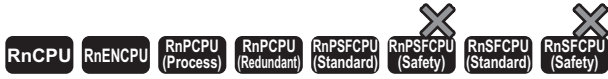

- For the R00CPU, R01CPU, and R02CPU, there are no restrictions on the version.
- The RnCPU (excluding the R00CPU, R01CPU, and R02CPU) and RnENCPU with firmware version "22" or later support this instruction. Use an engineering tool with version "1.025B" or later.
- The RnPCPU (process) and the RnPCPU (redundant) with firmware version "04" or later support this instruction. Use an engineering tool with version "1.025B" or later.
- The RnSFCPU (standard) with firmware version "06" or later supports this instruction. Use an engineering tool with version "1.025B" or later.
- The RJ71GF11-T2 and RJ71EN71 with firmware version "12" or later support this instruction. Use an engineering tool with version "1.025B" or later.

This instruction reads data from the buffer memory area of the intelligent device station or the remote device station (in units of words, 32-bit address specified).

Ladder	ST
	ENO:=JP_REMFRD(EN,J,s1,s2,s3,s4,n,d1,d2);

FBD/LD

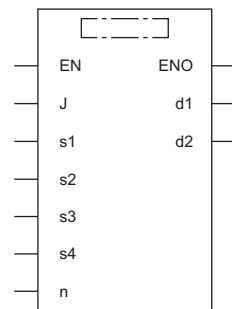

■ Execution condition

Instruction	Execution condition
JP.REMFRD	

Setting data

■Description, range, data type

Operand	Description	Range	Data type	Data type (label)
(J)	Target network number	1 to 239	16-bit unsigned binary	ANY16
(s1)	Channel of the own station, which is used for the instruction ^{*1}	1 to 32	16-bit unsigned binary	ANY16
(s2)	Target station number ^{*4}	1 to 120	16-bit unsigned binary	ANY16
(s3)	Start I/O number of target station	■Head module: 00H to FEH ^{*2} ■Modules other than the head module: 00H (fixed)	16-bit unsigned binary	ANY16
(s4)	Start address of the buffer memory area of the intelligent device station or the remote device station where the read-target data is stored	0000H to FFFFFFFFH (0 to 4294967295)	32-bit unsigned binary	ANY32
(d1)	Start device of the own station for storing the read data	—	Device name	ANY16 ^{*3}
(n)	Number of read data points (in units of words)	1 to 240	16-bit unsigned binary	ANY16
(d2)	Device of the own station, which turns on for one scan upon completion of the instruction. When the instruction completes with an error, (d2)+1 also turns on.	—	Bit	ANYBIT_ARRAY (Number of elements: 2)
EN	Execution condition	—	Bit	BOOL
ENO	Execution result	—	Bit	BOOL

*1 A channel is used only for the REMFR, REMTO, REMFRD, and REMTOD instructions.

The same channel number used for the link dedicated instructions (such as the READ instruction) can be set.

*2 This is the start I/O number (first three digits in four-digit hexadecimal representation) of intelligent function modules.

*3 When specifying setting data by using a label, define an array to secure enough operation area and specify an element of the array label.

*4 When a station in a redundant system is targeted, specify the station number in the control system by using the module FB (RedundantSystem_GetAddress).

📖 MELSEC iQ-R Ethernet, CC-Link IE, and MELSECNET/H Function Block Reference

■Applicable devices

Operand	Bit		Word				Double word		Indirect specification	Constant			Others (J)
	X, Y, M, L, SM, F, B, SB, FX, FY	J□\□	T, ST, C, D, W, SD, SW, FD, R, ZR, RD	U□\G□, J□\□, U3E□\□(H)G□	Z	LT, LST, LC	LZ	K, H		E	\$		
(J)	—	—	—	—	—	—	—	—	—	—	—	—	○
(s1)	○ ^{*1}	—	○ ^{*2}	—	—	—	○	○	○	—	—	—	—
(s2)	○ ^{*1}	—	○ ^{*2}	—	—	—	○	○	○	—	—	—	—
(s3)	○ ^{*1}	—	○ ^{*2}	—	—	—	○	○	○	—	—	—	—
(s4)	○ ^{*1}	—	○ ^{*2}	—	○	—	○	○	○	—	—	—	—
(d1)	—	—	○ ^{*2}	—	—	—	○	○	○	—	—	—	—
(n)	○ ^{*1}	—	○ ^{*2}	—	—	—	○	○	○	—	—	—	—
(d2)	○ ^{*1}	—	○ ^{*3}	—	—	—	—	—	—	—	—	—	—

*1 FX and FY cannot be used.

*2 FD cannot be used.

*3 T, ST, C, and FD cannot be used.

Processing details

- This instruction reads the data from the start address (s4) of the buffer memory area of the intelligent device station or the remote device station to the word device ((d1) and later) of the own station for the specified number of words (n). Specify the target station by using (J), (s2), and (s3). The completion device (d2) turns on upon completion of the instruction.

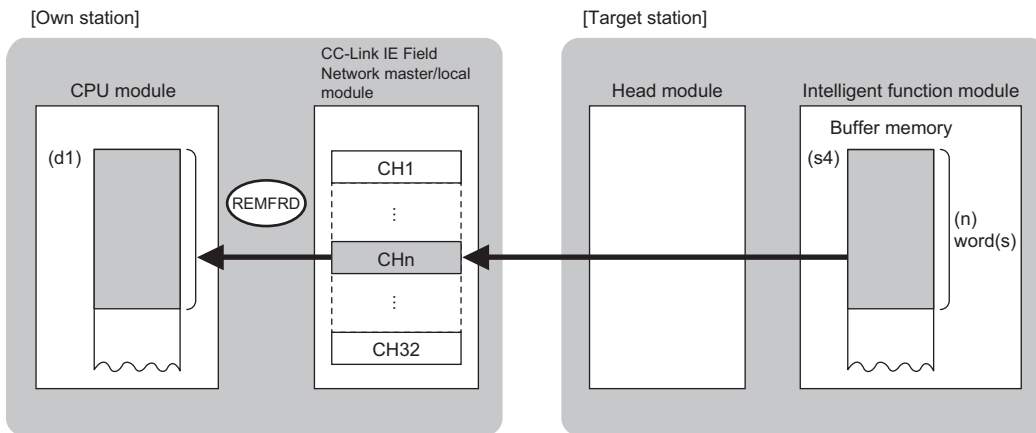

CH: Channel

- The execution status and the completion status of the REMFRD instruction can be checked with the completion device (d2) and the completion status indication device (d2)+1.

- Completion device (d2)

This device turns on during END processing of the scan where the REMFRD instruction completes, and turns off during the next END processing.

- Completion status indication device (d2)+1

This device turns on or off depending on the completion status of the REMFRD instruction.

When completed successfully: The device remains off.

When completed with an error: The device turns on during END processing of the scan where the REMFRD instruction completes, and turns off during the next END processing.

• The following figure shows the operation at completion of the REMFRD instruction.

• When completed successfully

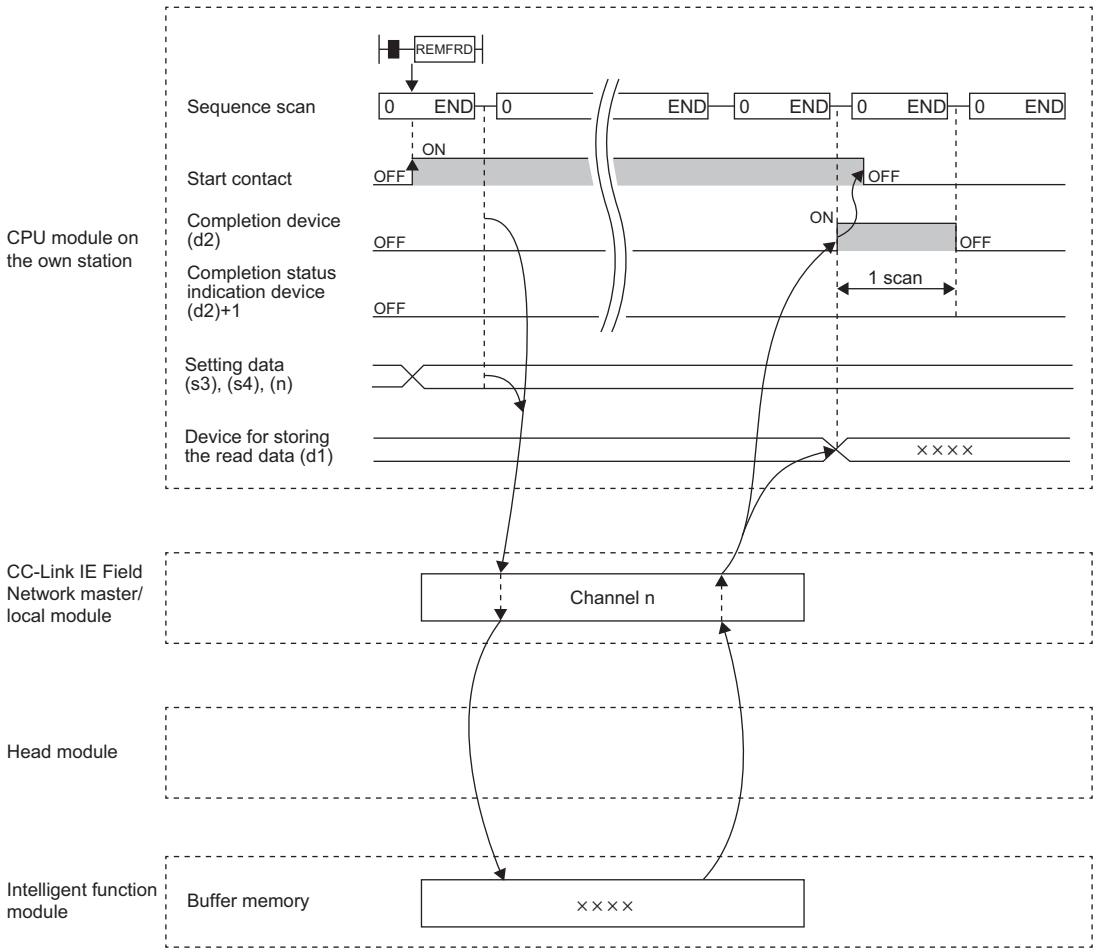

• When completed with an error

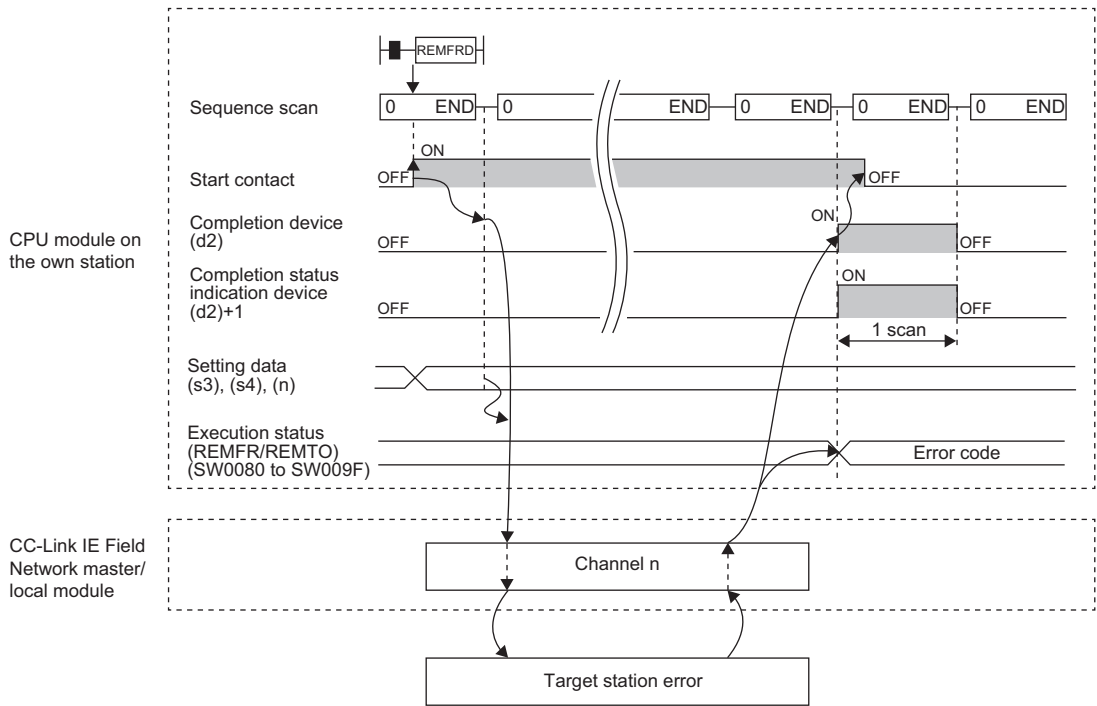

Point

For the REMFRD instruction, the number of resends and the response wait timer can be set in the following link special register (SW) areas.



- Number of resends (REMFR/REMTO) (SW001A)
- Response wait timer (REMFR/REMTO) (SW001B)

If the number of resends (REMFR/REMTO) (SW001A) is set, the REMFRD instruction completes with an error after the following time has elapsed:

(Number of resends (REMFR/REMTO) + 1) × Response wait timer (REMFR/REMTO)

Note, however, that no retry is performed if the target station is disconnected. If the REMFRD instruction completes with an error, execute the instruction again after the target station returns to the system.

Operation error

Error code (SW0080 to SW009F)	Description
4000H to 4FFFH	 MELSEC iQ-R CPU Module User's Manual (Application)
D000H to DFFFH	 MELSEC iQ-R CC-Link IE Field Network User's Manual (Application)

7.4 Writing Data to the Intelligent Device Station/ Remote Device Station (32-bit Address Specified)

JP.REMTOD

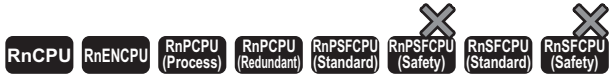

- For the R00CPU, R01CPU, and R02CPU, there are no restrictions on the version.
- The RnCPU (excluding the R00CPU, R01CPU, and R02CPU) and RnENCPU with firmware version "22" or later support this instruction. Use an engineering tool with version "1.025B" or later.
- The RnPCPU (process) and the RnPCPU (redundant) with firmware version "04" or later support this instruction. Use an engineering tool with version "1.025B" or later.
- The RnSFCPU (standard) with firmware version "06" or later supports this instruction. Use an engineering tool with version "1.025B" or later.
- The RJ71GF11-T2 and RJ71EN71 with firmware version "12" or later support this instruction. Use an engineering tool with version "1.025B" or later.

This instruction writes data to the buffer memory area of the intelligent device station or the remote device station (in units of words, 32-bit address specified).

Ladder	ST
	ENO:=JP_REMTOD(EN,J,s1,s2,s3,s4,s5,n,d);

FBD/LD

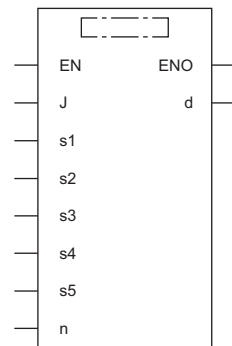

■ Execution condition

Instruction	Execution condition
JP.REMTOD	

Setting data

■Description, range, data type

Operand	Description	Range	Data type	Data type (label)
(J)	Target network number	1 to 239	16-bit unsigned binary	ANY16
(s1)	Channel of the own station, which is used for the instruction ^{*1}	1 to 32	16-bit unsigned binary	ANY16
(s2)	Target station number ^{*4}	1 to 120	16-bit unsigned binary	ANY16
(s3)	Start I/O number of target station	■Head module: 00H to FEH ^{*2} ■Modules other than the head module: 00H (fixed)	16-bit unsigned binary	ANY16
(s4)	Start address of the buffer memory area of the intelligent device station or the remote device station where the data is written	0000H to FFFFFFFFH (0 to 4294967295)	32-bit unsigned binary	ANY32
(s5)	Start device of the own station, where the write-target data is stored	—	Device name	ANY16 ^{*3}
(n)	Number of write data points (in units of words)	1 to 240	16-bit unsigned binary	ANY16
(d)	Device of the own station, which turns on for one scan upon completion of the instruction. When the instruction completes with an error, (d)+1 also turns on.	—	Bit	ANYBIT_ARRAY (Number of elements: 2)
EN	Execution condition	—	Bit	BOOL
ENO	Execution result	—	Bit	BOOL

*1 A channel is used only for the REMFR, REMTO, REMFRD, and REMTOD instructions.

The same channel number used for the link dedicated instructions (such as the READ instruction) can be set.

*2 This is the start I/O number (first three digits in four-digit hexadecimal representation) of intelligent function modules.

*3 When specifying setting data by using a label, define an array to secure enough operation area and specify an element of the array label.

*4 When a station in a redundant system is targeted, specify the station number in the control system by using the module FB (RedundantSystem_GetAddress).

📖 MELSEC iQ-R Ethernet, CC-Link IE, and MELSECNET/H Function Block Reference

■Applicable devices

Operand	Bit		Word			Double word			Indirect specification	Constant				Others (J)	
	X, Y, M, L, SM, F, B, SB, FX, FY	J□□□	T, ST, C, D, W, SD, SW, FD, R, ZR, RD	U□□G□, J□□□, U3E□(H)G□	Z	LT, LST, LC	LZ	K, H, E, \$							
(J)	—	—	—	—	—	—	—	—	—	—	—	—	—	—	○
(s1)	○ ^{*1}	—	○ ^{*2}	—	—	—	—	○	—	○	—	—	—	—	—
(s2)	○ ^{*1}	—	○ ^{*2}	—	—	—	—	○	—	○	—	—	—	—	—
(s3)	○ ^{*1}	—	○ ^{*2}	—	—	—	—	○	—	○	—	—	—	—	—
(s4)	○ ^{*1}	—	○ ^{*2}	—	—	○	—	○	—	○	—	—	—	—	—
(s5)	—	—	○ ^{*2}	—	—	—	—	○	—	○	—	—	—	—	—
(n)	○ ^{*1}	—	○ ^{*2}	—	—	—	—	○	—	○	—	—	—	—	—
(d)	○ ^{*1}	—	○ ^{*3}	—	—	—	—	—	—	—	—	—	—	—	—

*1 FX and FY cannot be used.

*2 FD cannot be used.

*3 T, ST, C, and FD cannot be used.

Processing details

- This instruction writes the data from the start device (s5) of the own station to the buffer memory area ((s4) and later) of the intelligent device station or the remote device station for the specified number of words (n). Specify the target station by using (J), (s2), and (s3). The completion device (d) turns on upon completion of the instruction.

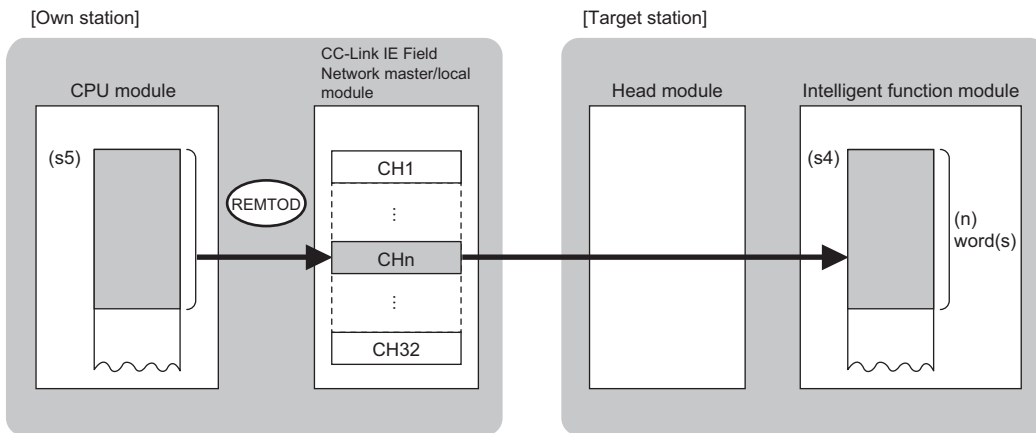

CH: Channel

- The execution status and the completion status of the REMTOD instruction can be checked with the completion device (d) and the completion status indication device (d)+1.

- Completion device (d)

This device turns on during END processing of the scan where the REMTOD instruction completes, and turns off during the next END processing.

- Completion status indication device (d)+1

This device turns on or off depending on the completion status of the REMTOD instruction.

When completed successfully: The device remains off.

When completed with an error: The device turns on during END processing of the scan where the REMTOD instruction completes, and turns off during the next END processing.

• The following figure shows the operation at completion of the REMTOD instruction.

• When completed successfully

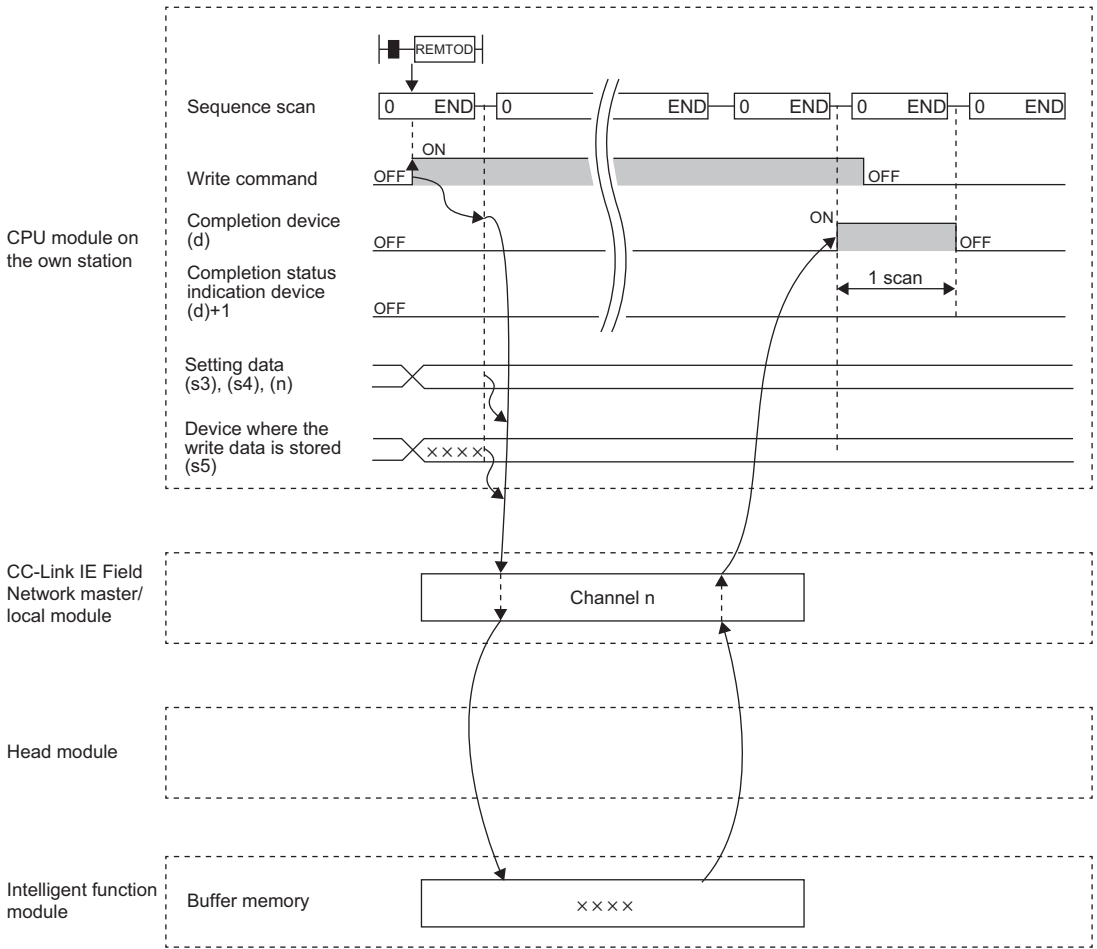

• When completed with an error

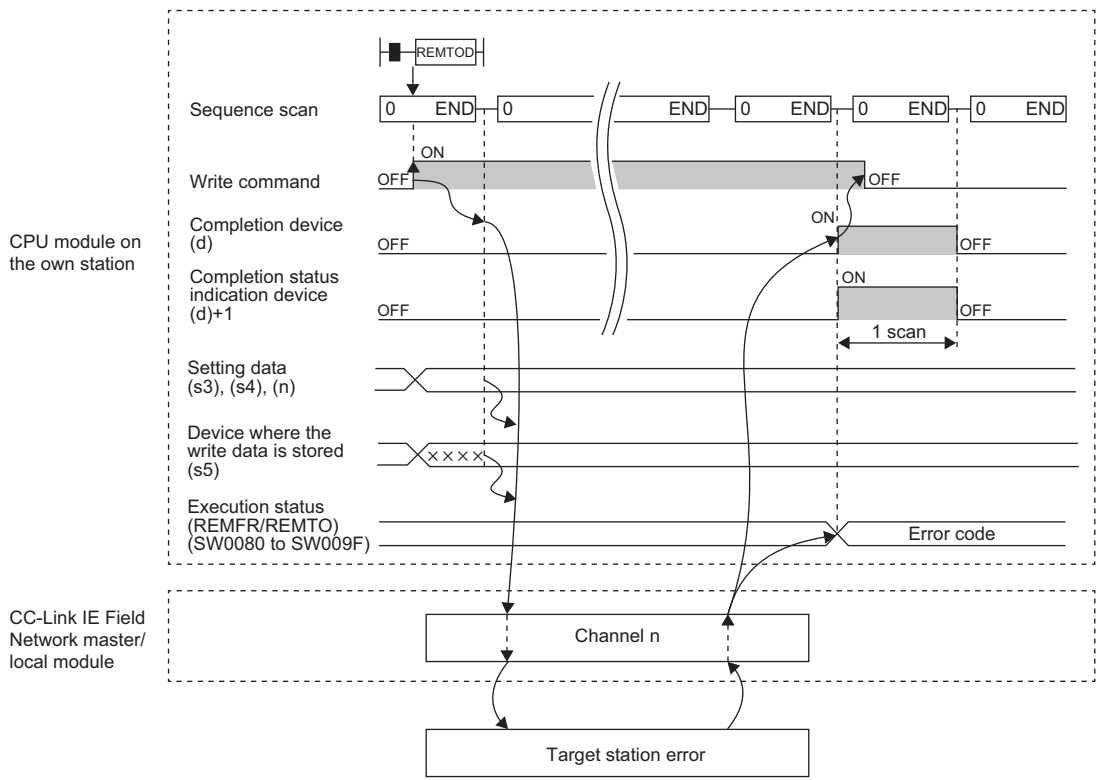

Point

For the REMTOD instruction, the number of resends and the response wait timer can be set in the following link special register (SW) areas.



- Number of resends (REMFR/REMTO) (SW001A)
- Response wait timer (REMFR/REMTO) (SW001B)

If the number of resends (REMFR/REMTO) (SW001A) is set, the REMTOD instruction completes with an error after the following time has elapsed:

(Number of resends (REMFR/REMTO) + 1) × Response wait timer (REMFR/REMTO)

Note, however, that no retry is performed if the target station is disconnected. If the REMTOD instruction completes with an error, execute the instruction again after the target station returns to the system.

Operation error

Error code (SW0080 to SW009F)	Description
4000H to 4FFFH	 MELSEC iQ-R CPU Module User's Manual (Application)
D000H to DFFFH	 MELSEC iQ-R CC-Link IE Field Network User's Manual (Application)

7.5 Reading the Module Model Information of an Intelligent Device Station

J(P).SINFTYRD, G(P).SINFTYRD



• The RnENCPU (network part), RJ71GF11-T2, and RJ71EN71 with firmware version "12" or later support these instructions. Use an engineering tool with version "1.025B" or later.

These instructions read the model names of modules and units used in an intelligent device station.

Ladder	ST
	<pre>ENO:=J_SINFTYRD(EN,J,s,d1,d2); ENO:=JP_SINFTYRD(EN,J,s,d1,d2); ENO:=G_SINFTYRD(EN,U,s,d1,d2); ENO:=GP_SINFTYRD(EN,U,s,d1,d2);</pre>

FBD/LD

Execution condition

Instruction	Execution condition
J.SINFTYRD G.SINFTYRD	
JP.SINFTYRD GP.SINFTYRD	

Setting data

Description, range, data type

Operand	Description	Range	Data type	Data type (label)
(J/U)	J(P).SINFTYRD (J): Own station network number	1 to 239	16-bit unsigned binary	ANY16
	G(P).SINFTYRD (U): Start I/O number (first three digits in four-digit hexadecimal representation) of own station or own node	00H to FEH	16-bit unsigned binary	ANY16
(s)	Start device of the own station where control data is stored	Refer to the control data.	Device name	ANY16*1
(d1)	Start device of the own station for storing the read data (A continuous area of 890 words is required.)	—	Device name	ANY16*1
(d2)	Device of the own station, which turns on for one scan upon completion of the instruction. When the instruction completes with an error, (d2)+1 also turns on.	—	Bit	ANYBIT_ARRAY (Number of elements: 2)
EN	Execution condition	—	Bit	BOOL
ENO	Execution result	—	Bit	BOOL

*1 When specifying setting data by using a label, define an array to secure enough operation area and specify an element of the array label.

■Applicable devices

Operand		Bit		Word			Double word		Indirect specification	Constant			Others	
		X, Y, M, L, SM, F, B, SB, FX, FY	J□□	T, ST, C, D, W, SD, SW, FD, R, ZR, RD	U□\G□, J□\□, U3E□\□(H)G□	Z	LT, LST, LC	LZ		K, H	E	\$	J	U
(J/U)	J(P).SINFTYRD	—	—	—	—	—	—	—	—	—	—	—	—	—
	G(P).SINFTYRD	—	—	○	—	—	—	—	○	○	—	—	—	○
(s)		—	—	○*2	—	—	—	—	○	—	—	—	—	—
(d1)		—	—	○*2	—	—	—	—	○	—	—	—	—	—
(d2)		○*1	—	○*3	—	—	—	—	—	—	—	—	—	—

*1 FX and FY cannot be used.

*2 FD cannot be used.

*3 T, ST, C, and FD cannot be used.

■Control data

Operand: (s)				
Device	Item	Description	Setting range	Set by
+0	Error completion type	b15 ... b8 b7 ... b0 <div style="border: 1px solid black; padding: 2px; display: inline-block;"> 0 (2)(1) 0 </div> <p>(1) Error completion type (bit 7) Specify whether to set data at completion with an error.</p> <ul style="list-style-type: none"> • 0: Do not set data at completion with an error in (s)+12 and later. • 1: Set data at completion with an error in (s)+12 and later. <p>(2) Arrival check time setting (bit 8)</p> <ul style="list-style-type: none"> • 0: 1s units • 1: 100ms units 	0000H 0080H 0100H 0180H	User
+1	Completion status	The instruction completion status is stored.	—	System
+2	Channel of the own station, which is used for the system configuration instruction	Specify the channel to be used by own station.	1 to 32	User
+3 to +4	—	Not used	—	System
+5	Target station number	Specify the station number of the target station.	1 to 120	User
+6	—	Not used	—	System
+7	Number of resends	<p>■Before instruction execution</p> Specify the number of resends to be performed if the instruction is not completed within the monitoring time specified by (s)+8. <ul style="list-style-type: none"> • 0 to 15 times <p>■At completion of instruction</p> The number of resends performed (result) is stored. <ul style="list-style-type: none"> • 0 to 15 times 	0 to 15	User/ system
+8	Arrival monitoring time	Specify the monitoring time until completion of processing. If processing is not completed within the monitoring time, the request is resent by the number of resends specified in (s)+7. <p>■When "0" is specified in bit 8 of (s)+0</p> <ul style="list-style-type: none"> • 0: 10s • 1 to 32767: 1 to 32767s <p>■When "1" is specified in bit 8 of (s)+0</p> <ul style="list-style-type: none"> • 0: 10s • 1 to 65535: 1 to 65535 × 100ms 	0 to 65535	User
+9 to +10	—	Not used	—	System
+11	Clock setting flag	The validity status (valid or invalid) of the data in (s)+12 and later is stored. Note that the data in (s)+12 and later is not cleared even when the instruction is completed successfully. <ul style="list-style-type: none"> • 0: Invalid • 1: Valid 	—	System

Operand: (s)				
Device	Item	Description	Setting range	Set by
+12	Clock data (Set only in an abnormal state)	Upper 8 bits: Month (01H to 12H) Lower 8 bits: Year (00H to 99H: Lower two digits of the year)	—	System
+13		Upper 8 bits: Hour (00H to 23H) Lower 8 bits: Day (01H to 31H)	—	System
+14		Upper 8 bits: Second (00H to 59H) Lower 8 bits: Minute (00H to 59H)	—	System
+15		Upper 8 bits: Year (00H to 99H: Upper two digits of the year) Lower 8 bits: Day of the week (00H (Sun.) to 06H (Sat.))	—	System
+16		Error detection network number	The network number of the station in which an error was detected is stored. (No information is stored if an error is detected in the own station.) • 1 to 239 (Network number)	—
+17	Error-detected station number	The number of the station where an error was detected is stored. (No information is stored if an error is detected in the own station.) • 125: Master station • 1 to 120: Local station, intelligent device station, submaster station	—	System

Processing details

- These instructions read the model names of modules and units used in an intelligent device station, and store the data to the device specified by (d1) and later. Upon completion of reading the model names, the completion device specified by (d2) turns on.

Operand	Item
(d1)+0 to (d1)+9	Main base unit: power supply information 1
(d1)+10 to (d1)+19	Main base unit: power supply information 2
(d1)+20 to (d1)+29	1st extension base unit: power supply information 1
(d1)+30 to (d1)+39	1st extension base unit: power supply information 2
⋮	⋮
(d1)+140 to (d1)+149	7th extension base unit: power supply information 1
(d1)+150 to (d1)+159	7th extension base unit: power supply information 2
(d1)+160 to (d1)+169	Main base unit information
(d1)+170 to (d1)+179	1st extension base unit information
⋮	⋮
(d1)+230 to (d1)+239	7th extension base unit information
(d1)+240 to (d1)+249	CPU slot: product information
(d1)+250 to (d1)+259	I/O slot 0: product information
(d1)+260 to (d1)+269	I/O slot 1: product information
⋮	⋮
(d1)+880 to (d1)+889	I/O slot 63: product information

- The result of instruction execution is stored in the 1st word and a model name is stored in the 2nd to 10th words of each item. The following table lists the values to be stored in the corresponding words.

Condition	1st word	2nd to 10th words
The read target module or unit has a model name.	0	Model name held by a module or a unit
The read target module or unit does not have a model name.	1	Character string consisting of module type and the number of points
The read target slot is empty.	-1*1	0000H
The read target module is being changed online.		

*1 If the read target module has a hardware failure, -1 may be stored in the 1st word.

- When the read target module has a model name, the model name is stored in the 2nd word and later according to the following rules.
 - The name occupies nine words.
 - The name is stored in ASCII characters.
 - 00H is stored in the 18th character.
 - If the number of characters is less than 17, 00H is stored in the remaining characters.
 - The model name held by a module or a unit is stored. (Note that it may differ from the one written on the rating plate.)

Ex.

The following table lists examples of model names stored.

Target module	Character string example (module type)
Remote head module	RJ72GF15-T2
I/O module	INPUT_16
Network module	RJ71EN71(E+E)

Point

If the model name in the I/O assignment setting and that of the mounted module differ, the model name held by the mounted module is stored.

- When the read target module does not have a model name, the character string is stored in the 2nd word and later according to the following rules.
 - The name occupies nine words.
 - The name is stored in ASCII characters.
 - 00H is stored in the 18th character.
 - If the number of characters is less than 17, 00H is stored in the remaining characters.
 - A character string consisting of a combination of "character string indicating the module type" and "character string indicating the number of points" is stored.

Ex.

The following table lists examples of character strings stored (module type).

Target module	Model name example
Input module	INPUT_16
Output module	OUTPUT_32
I/O combined module	MIXED_64
Intelligent function module	INTELLIGENT_128

The following table lists examples of character strings stored (number of points).

Number of points	Character string example (number of points)
16 points	_16
32 points	_32
48 points	_48
64 points	_64
128 points	_128
256 points	_256
512 points	_512
1024 points	_1024

Point

If the number of points in the I/O assignment setting and that of the mounted module differ, the number of points of the mounted module is stored.

- The target station that can be specified is the intelligent device station (remote head module).

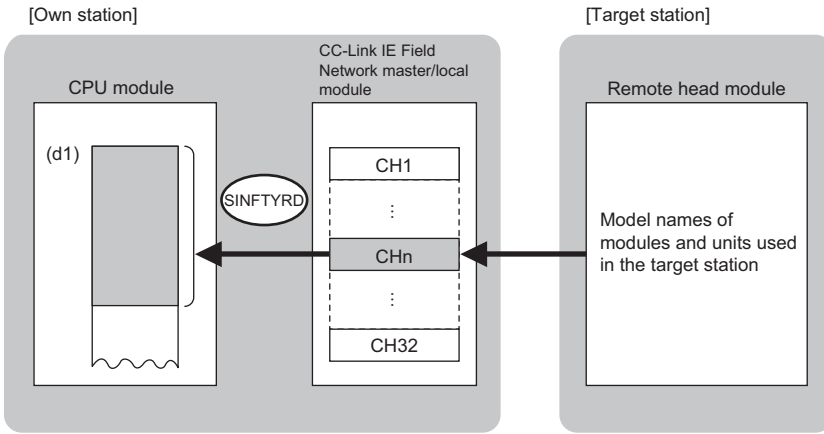

CH: Channel

- When executing multiple SINFTYRD instructions or multiple SINFSTRD instructions concurrently, do not specify the same own station channel for multiple SINFTYRD instructions or for multiple SINFSTRD instructions. If the same own station channel is specified, the SINFTYRD instructions or the SINFSTRD instructions cannot be used concurrently.
- The execution status and the completion status of the SINFTYRD instruction can be checked with the completion device (d2) and the completion status indication device (d2)+1.

- Completion device (d2)

This device turns on during END processing of the scan where the SINFTYRD instruction completes, and turns off during the next END processing.

- Completion status indication device (d2)+1

This device turns on or off depending on the completion status of the SINFTYRD instruction.

When completed successfully: The device remains off.

When completed with an error: The device turns on during END processing of the scan where the SINFTYRD instruction completes, and turns off during the next END processing.

- The following figures show the execution timing of the SINFTYRD instruction.

- When completed successfully

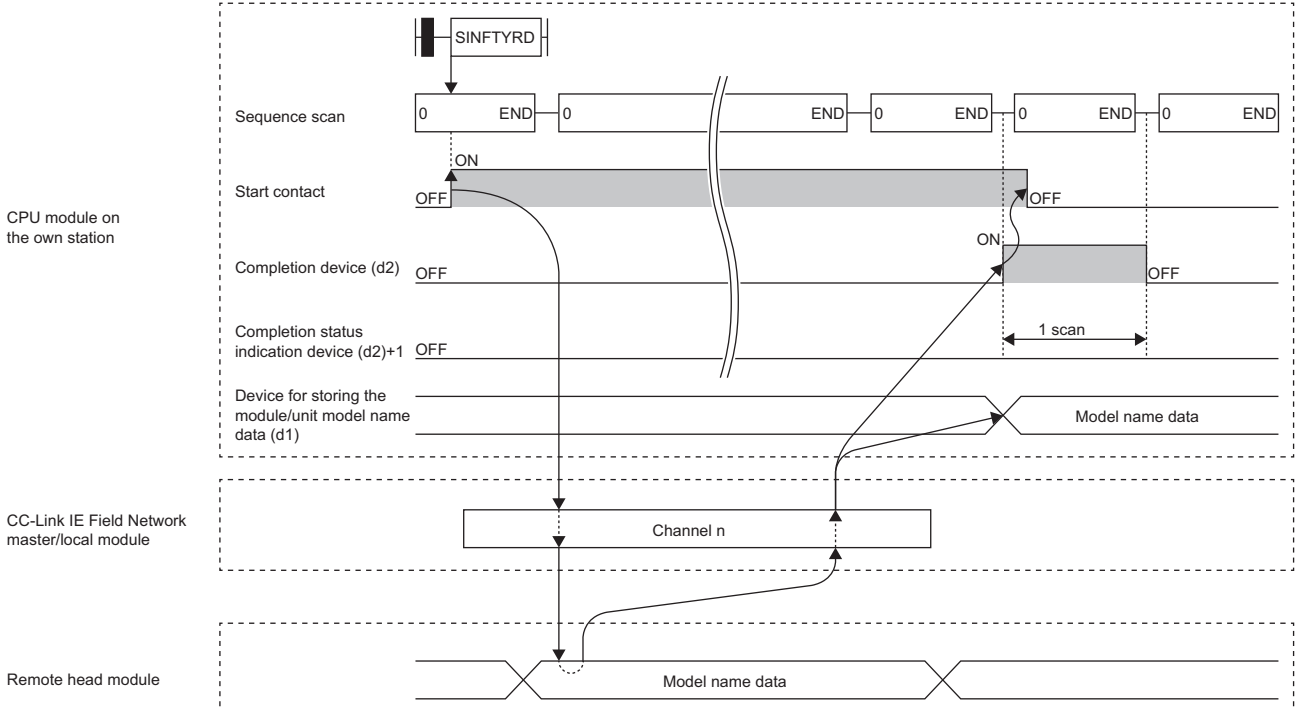

- When completed with an error

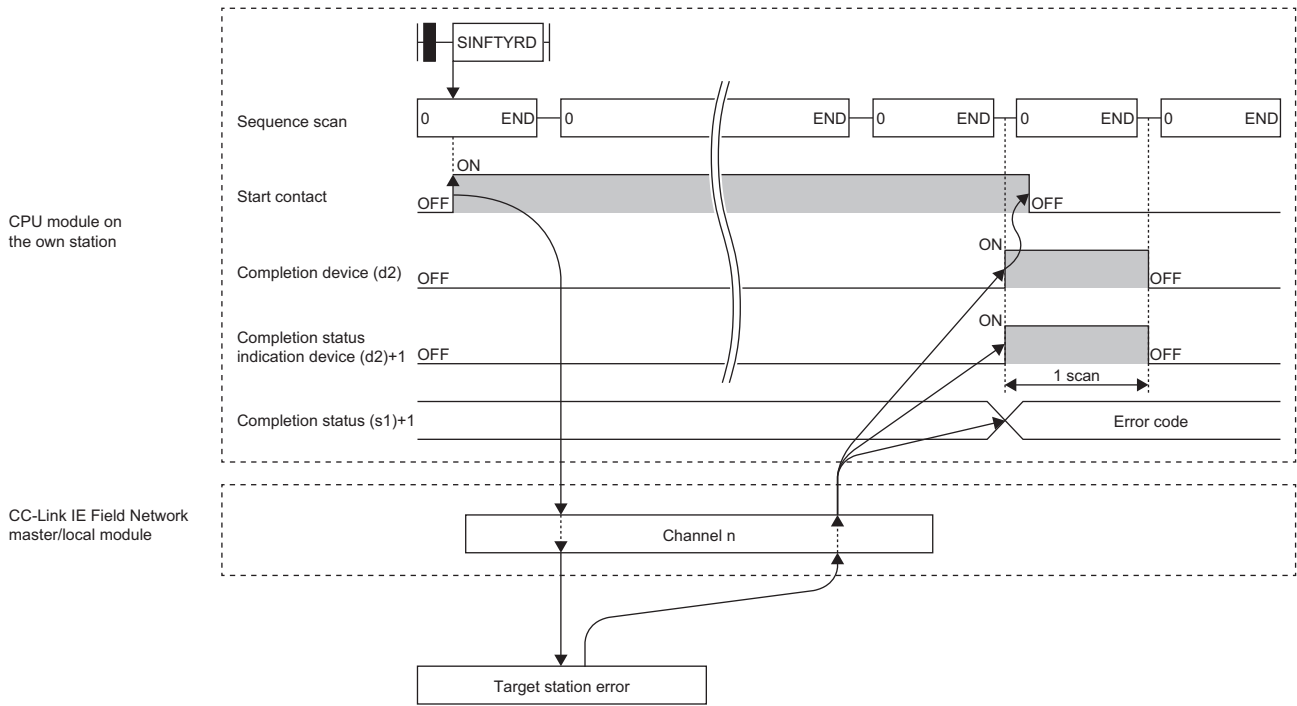

- Read processing is performed only once on the rising edge when the read command turns on.

Operation error

Error code ((s)+1)	Description
D000H to DFFFH	MELSEC iQ-R CC-Link IE Field Network User's Manual (Application)

7.6 Reading the Module Status Information of an Intelligent Device Station

J(P).SINFSTRD, G(P).SINFSTRD

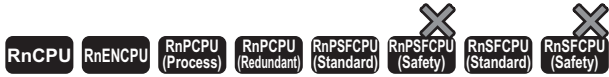

• The RnENCPU (network part), RJ71GF11-T2, and RJ71EN71 with firmware version "12" or later support these instructions. Use an engineering tool with version "1.025B" or later.

These instructions read the status information of modules and units used in an intelligent device station.

Ladder	ST
	<pre>ENO:=J_SINFSTRD(EN,J,s,d1,d2); ENO:=JP_SINFSTRD(EN,J,s,d1,d2); ENO:=G_SINFSTRD(EN,U,s,d1,d2); ENO:=GP_SINFSTRD(EN,U,s,d1,d2);</pre>

FBD/LD

Execution condition

Instruction	Execution condition
J.SINFSTRD G.SINFSTRD	
JP.SINFSTRD GP.SINFSTRD	

Setting data

Description, range, data type

Operand	Description	Range	Data type	Data type (label)	
(J/U)	J(P).SINFSTRD	(J): Own station network number	1 to 239	16-bit unsigned binary	ANY16
	G(P).SINFSTRD	(U): Start I/O number (first three digits in four-digit hexadecimal representation) of own station or own node	00H to FEH	16-bit unsigned binary	ANY16
(s)	Start device of the own station where control data is stored	Refer to the control data.	Device name	ANY16 ^{*1}	
(d1)	Start device of the own station for storing the read data (A continuous area of 356 words is required.)	—	Device name	ANY16 ^{*1}	
(d2)	Device of the own station, which turns on for one scan upon completion of the instruction. When the instruction completes with an error, (d2)+1 also turns on.	—	Bit	ANYBIT_ARRAY (Number of elements: 2)	
EN	Execution condition	—	Bit	BOOL	
ENO	Execution result	—	Bit	BOOL	

*1 When specifying setting data by using a label, define an array to secure enough operation area and specify an element of the array label.

■Applicable devices

Operand	Bit		Word			Double word		Indirect specification	Constant			Others	
	X, Y, M, L, SM, F, B, SB, FX, FY	J□□□	T, ST, C, D, W, SD, SW, FD, R, ZR, RD	U□□□, J□□□, U3E□□(H)□□	Z	LT, LST, LC	LZ		K, H	E	\$	J	U
(J/U)	J(P).S INFST RD	—	—	—	—	—	—	—	—	—	—	—	—
	G(P). SINFST TRD	—	—	○	—	—	—	○	—	—	—	—	○
(s)	—	—	○*2	—	—	—	—	○	—	—	—	—	—
(d1)	—	—	○*2	—	—	—	—	○	—	—	—	—	—
(d2)	○*1	—	○*3	—	—	—	—	—	—	—	—	—	—

*1 FX and FY cannot be used.

*2 FD cannot be used.

*3 T, ST, C, and FD cannot be used.

■Control data

Operand: (s)				
Device	Item	Description	Setting range	Set by
+0	Error completion type	b15 ... b8 b7 ... b0 <div style="border: 1px solid black; padding: 2px; display: inline-block; margin: 5px 0;"> 0 (2) (1) 0 </div> (1) Error completion type (bit 7) Specify whether to set data at completion with an error. • 0: Do not set data at completion with an error in (s)+12 and later. • 1: Set data at completion with an error in (s)+12 and later. (2) Arrival check time setting (bit 8) • 0: 1s units • 1: 100ms units	0000H 0080H 0100H 0180H	User
+1	Completion status	The instruction completion status is stored. • 0: Normal • Other than 0: Error (error code)	—	System
+2	Channel of the own station, which is used for the system configuration instruction	Specify the channel to be used by own station.	1 to 32	User
+3 to +4	—	Not used	—	System
+5	Target station number	Specify the station number of the target station.	1 to 120	User
+6	—	Not used	—	System
+7	Number of resends	■Before instruction execution Specify the number of resends to be performed if the instruction is not completed within the monitoring time specified by (s)+8. • 0 to 15 times ■At completion of instruction The number of resends performed (result) is stored. • 0 to 15 times	0 to 15	User/ system
+8	Arrival monitoring time	Specify the monitoring time until completion of processing. If processing is not completed within the monitoring time, the request is resent by the number of resends specified in (s)+7. ■When "0" is specified in bit 8 of (s)+0 • 0: 10s • 1 to 32767: 1 to 32767s ■When "1" is specified in bit 8 of (s)+0 • 0: 10s • 1 to 65535: 1 to 65535 × 100ms	0 to 65535	User
+9 to +10	—	Not used	—	System
+11	Clock setting flag	The validity status (valid or invalid) of the data in (s)+12 and later is stored. Note that the data in (s)+12 and later is not cleared even when the instruction is completed successfully. • 0: Invalid • 1: Valid	—	System

Operand: (s)				
Device	Item	Description	Setting range	Set by
+12	Clock data (Set only in an abnormal state)	Upper 8 bits: Month (01H to 12H) Lower 8 bits: Year (00H to 99H: Lower two digits of the year)	—	System
+13		Upper 8 bits: Hour (00H to 23H) Lower 8 bits: Day (01H to 31H)	—	System
+14		Upper 8 bits: Second (00H to 59H) Lower 8 bits: Minute (00H to 59H)	—	System
+15		Upper 8 bits: Year (00H to 99H: Upper two digits of the year) Lower 8 bits: Day of the week (00H (Sun.) to 06H (Sat.))	—	System
+16	Error detection network number	The network number of the station in which an error was detected is stored. (No information is stored if an error is detected in the own station.) • 1 to 239 (Network number)	—	System
+17	Error-detected station number	The number of the station where an error was detected is stored. (No information is stored if an error is detected in the own station.) • 125: Master station • 1 to 120: Local station, intelligent device station, submaster station	—	System

Processing details

- These instructions read the status information of modules and units used in an intelligent device station, and store the data to the device specified by (d1) and later. Upon completion of reading the status information, the completion device specified by (d2) turns on.

Operand	Item
(d1)+0 to (d1)+3	Main base unit: power supply information 1
(d1)+4 to (d1)+7	Main base unit: power supply information 2
(d1)+8 to (d1)+11	1st extension base unit: power supply information 1
(d1)+12 to (d1)+15	1st extension base unit: power supply information 2
⋮	⋮
(d1)+56 to (d1)+59	7th extension base unit: power supply information 1
(d1)+60 to (d1)+63	7th extension base unit: power supply information 2
(d1)+64 to (d1)+67	Main base unit information
(d1)+68 to (d1)+71	1st extension base unit information
⋮	⋮
(d1)+92 to (d1)+95	7th extension base unit information
(d1)+96 to (d1)+99	CPU slot: product information
(d1)+100 to (d1)+103	I/O slot 0: product information
(d1)+104 to (d1)+107	I/O slot 1: product information
⋮	⋮
(d1)+352 to (d1)+355	I/O slot 63: product information

- The following table lists the values to be stored in the corresponding words.

○: Supported, —: Not supported*1

Device	Bit	Item	Description	Power supply module	Base unit	Modules mounted on the CPU slot and slot No.0 to No.63
1st word	b0 to b3	Reserved	Fixed to 0	—	—	—
	b4 to b7	Module type*2	0000:Input module, or not set (default) 0010:Output module 0100:I/O combined module (different numbers) 0110:I/O combined module (same number) 1000:Intelligent function module Further details can be checked in b0 to b3 of the 3rd word.	○	○	○
	b8 to b10	Series*2	000:— (default) 010:MELSEC-Q series module 011:MELSEC iQ-R series module 111:Unknown	○	○	○
	b11 to b15	Reserved	Fixed to 0	—	—	—

Device	Bit	Item	Description	Power supply module	Base unit	Modules mounted on the CPU slot and slot No.0 to No.63
2nd word	b0 to b1	Error status ^{*2}	00: No error (default) 01: Minor error 10: Moderate error 11: Major error	○	○	○
	b2	Module ready status ^{*2}	0: Not ready (default) 1: Ready	—	—	○
	b3 to b5	Reserved	Fixed to 0	—	—	—
	b6 to b7	Inter-module synchronization ^{*2}	00: Not synchronized (default) 01: Preparing for synchronization 10: Synchronized 11: Synchronization error	—	—	○
	b8 to b9	Reserved	Fixed to 0	—	—	—
	b10	External power supply ^{*2}	0: Normal operation (default) 1: Power off	—	—	○
	b11	Fuse ^{*2}	0: Normal operation (default) 1: Fuse blown	—	—	○
	b12	Reserved	Fixed to 0	—	—	—
	b13	Online module change	0: Not being performed (default) 1: Module being changed online	—	—	○
	b14	Reserved	Fixed to 0	—	—	—
	b15	Module access	0: Disabled (default) 1: Enabled	○	○	○ ^{*3}
	3rd word	b0 to b3	Module type details ^{*2}	0000:Not set (default) 0001:Remote head module 0010:Power supply module 0011:Base unit 0100:Input module 0101:Output module 0110:I/O combined module (different numbers) 0111:I/O combined module (same number) 1000:Intelligent function module 1111:Module or unit other than above	○	○
b4 to b7		Reserved	Fixed to 0	—	—	—
b8		Safety function setting ^{*2}	0: Invalid (default) 1: Valid	—	—	○
b9		Reserved	Fixed to 0	—	—	—
b10		Safety operation status ^{*2}	0: Not operating (default) 1: Operating	—	—	○
b11		Reserved	Fixed to 0	—	—	—
b12		Redundant function setting ^{*2}	0: Invalid (default) 1: Valid	—	—	○ ^{*4}
b14 to b15		Redundant operation status ^{*2}	00: Not operating (default) 01: Standby system 10: Control system	—	—	○ ^{*4}
4th word	—	Latest error code	0000:No error (default) Other than 0000:Error code	—	—	○

*1 If a module or a unit does not support the information, a default value is stored.

*2 A value is stored only when the value stored in b15 of the 2nd word (Module access) is 1 (enabled). When the value stored in b15 of the 2nd word is 0 (disabled), a default value is stored.

*3 When a module is mounted on a slot and accessible, 1 is stored. When a module occupying two or more slots is mounted, a value is stored only for a slot where a module is actually mounted.

*4 A value is stored only for a remote head module.

- The target station that can be specified is the intelligent device station (remote head module).

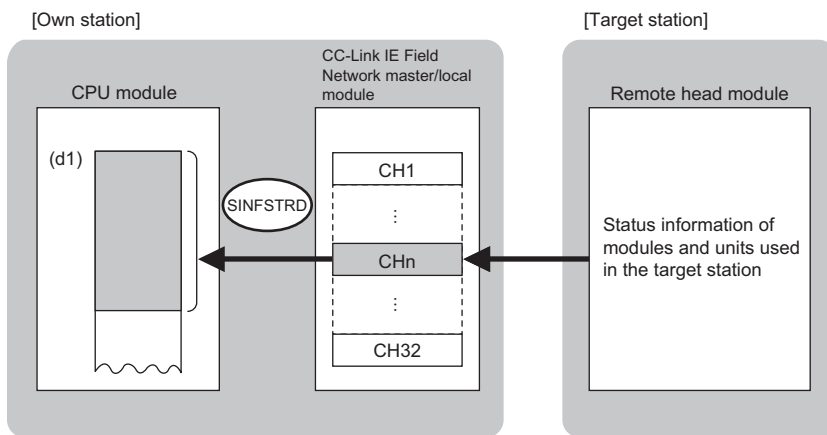

CH: Channel

- When executing multiple SINFSTRD instructions or multiple SINFSTRD instructions concurrently, do not specify the same own station channel for multiple SINFSTRD instructions or for multiple SINFSTRD instructions. If the same own station channel is specified, the SINFSTRD instructions or the SINFSTRD instructions cannot be used concurrently.
- The execution status and the completion status of the SINFSTRD instruction can be checked with the completion device (d2) and the completion status indication device (d2)+1.

- Completion device (d2)

This device turns on during END processing of the scan where the SINFSTRD instruction completes, and turns off during the next END processing.

- Completion status indication device (d2)+1

This device turns on or off depending on the completion status of the SINFSTRD instruction.

When completed successfully: The device remains off.

When completed with an error: The device turns on during END processing of the scan where the SINFSTRD instruction completes, and turns off during the next END processing.

- The following figures show the execution timing of the SINFSTRD instruction.

- When completed successfully

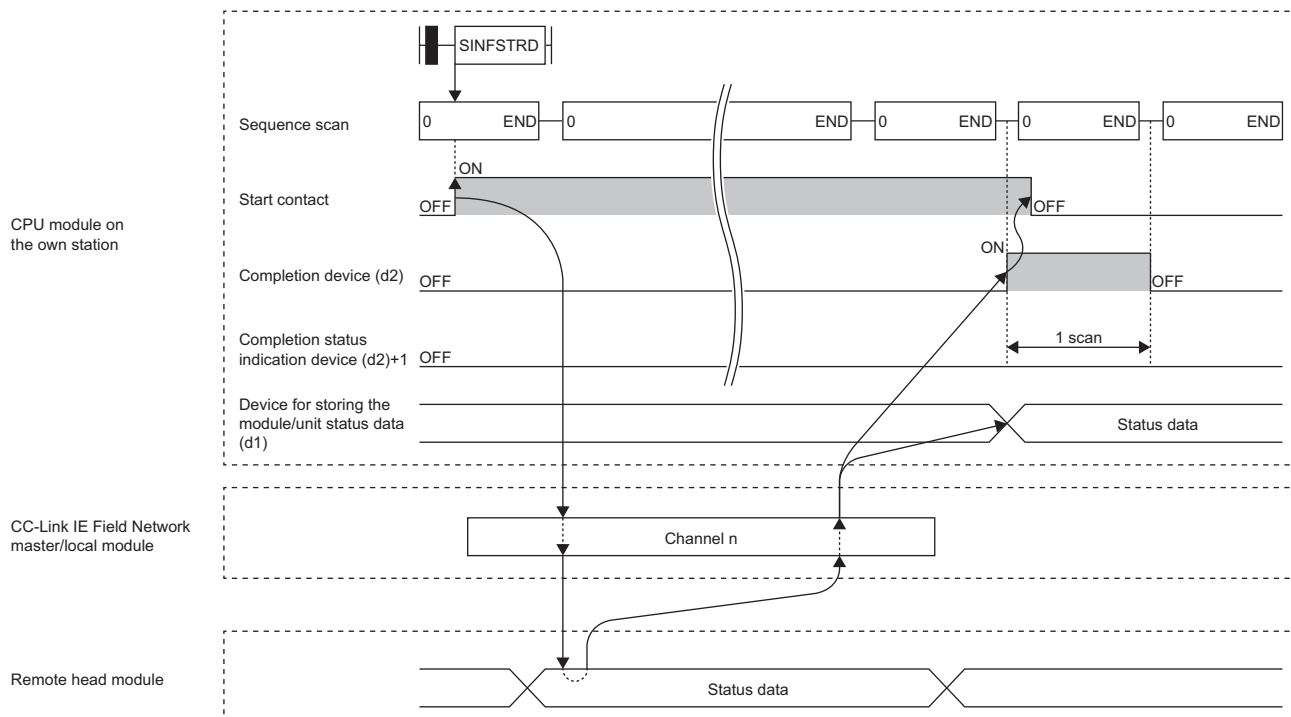

- When completed with an error

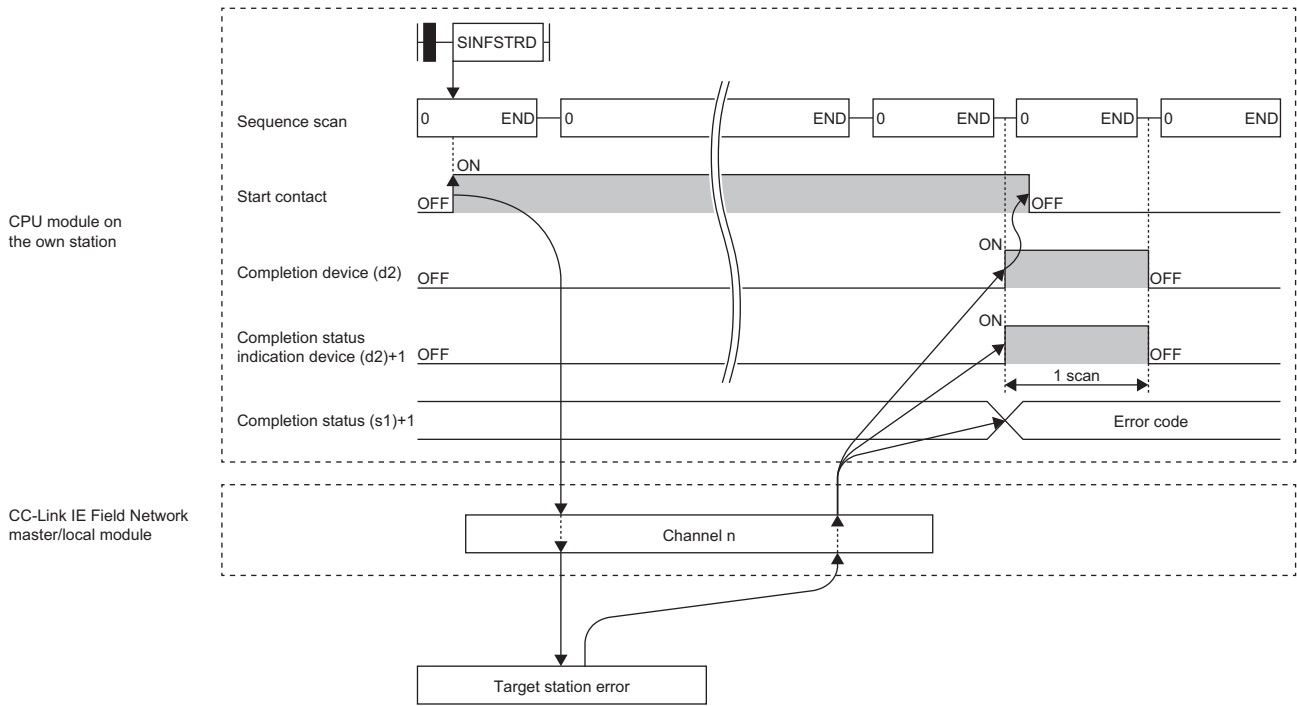

- Read processing is performed only once on the rising edge when the read command turns on.

Operation error

Error code ((s)+1)	Description
D000H to DFFFH	MELSEC iQ-R CC-Link IE Field Network User's Manual (Application)

7.7 Setting Parameters

G(P).CCPASET



These instructions set the parameters in the CC-Link IE Field Network master and local modules.

Ladder	ST
	<pre>ENO:=G_CCPASET(EN,U,s1,s2,s3,s4,d); ENO:=GP_CCPASET(EN,U,s1,s2,s3,s4,d);</pre>

FBD/LD

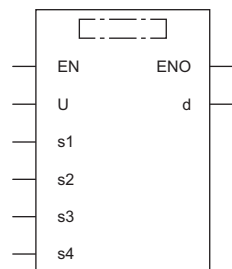

Execution condition

Instruction	Execution condition
G.CCPASET	
GP.CCPASET	

Setting data

Description, range, data type

Operand	Description	Range	Data type	Data type (label)
(U)	Start I/O number (first three digits in four-digit hexadecimal representation) of own station or own node	00H to FEH	16-bit unsigned binary	ANY16
(s1)	Own station start device where control data is stored	Refer to the control data.	Device name	ANY16 ^{*1}
(s2)	Own station start device where the network configuration settings is stored	—	Device name	ANY16 ^{*1}
(s3)	Own station start device where the reserved station specification is stored	—	Device name	ANY16 ^{*1}
(s4)	Own station start device where the error invalid station settings is stored	—	Device name	ANY16 ^{*1}
(d)	Device of the own station, which turns on for one scan upon completion of the instruction. When the instruction completes with an error, (d)+1 also turns on.	—	Bit	ANYBIT_ARRAY (Number of elements: 2)
EN	Execution condition	—	Bit	BOOL
ENO	Execution result	—	Bit	BOOL

*1 When specifying setting data by using a label, define an array to secure enough operation area and specify an element of the array label.

■Applicable devices

Operand	Bit		Word			Double word		Indirect specification	Constant			Others (U)
	X, Y, M, L, SM, F, B, SB, FX, FY	J□□	T, ST, C, D, W, SD, SW, FD, R, ZR, RD	U□\G□, J□\□, U3E□(H)G□	Z	LT, LST, LC	LZ		K, H	E	\$	
(U)	—	—	○	—	—	—	—	○	○	—	—	○
(s1)	—	—	○*2	—	—	—	—	○	—	—	—	—
(s2)	—	—	○*2	—	—	—	—	○	—	—	—	—
(s3)	—	—	○*2	—	—	—	—	○	—	—	—	—
(s4)	—	—	○*2	—	—	—	—	○	—	—	—	—
(d)	○*1	—	○*3	—	—	—	—	—	—	—	—	—

*1 FX and FY cannot be used.

*2 FD cannot be used.

*3 T, ST, C, and FD cannot be used.

■Control data

Operand: (s1)																		
Device	Item	Description	Setting range*1	Set by														
+0	Completion status	The instruction completion status is stored. <ul style="list-style-type: none"> • 0: Normal • Other than 0: Error (error code) 	—	System														
+1	Setting flag	Specifies whether the setting data in (s2) to (s4) are valid/invalid. b15 b14 b13 b12 b11 b10 b9 b8 b7 b6 b5 b4 b3 b2 b1 b0 <table border="1" style="margin-left: 20px;"> <tr> <td>0</td><td>(12)</td><td>(11)</td><td>(10)</td><td>(9)</td><td>(8)</td><td>(7)</td><td>(6)</td><td>0</td><td>(5)</td><td>(4)</td><td>(3)</td><td>(2)</td><td>(1)</td> </tr> </table> <ul style="list-style-type: none"> (1) Presence of network configuration setting data (bit 0) <ul style="list-style-type: none"> • 0: Invalid*2 • 1: Valid (2) Presence of reserved station setting data (bit 1) <ul style="list-style-type: none"> • 0: Invalid*2 • 1: Valid (3) Presence of error invalid station setting data (bit 2) <ul style="list-style-type: none"> • 0: Invalid*2 • 1: Valid (4) Presence of submaster function (bit 3) <ul style="list-style-type: none"> • 0: Invalid*2 • 1: Valid (5) Presence of IP packet transfer function (bits 4, 5) <ul style="list-style-type: none"> • 00: Invalid • 01: Valid (6) Data link faulty station setting (bit 8) <ul style="list-style-type: none"> • 0: Cleared • 1: Held (7) Output setting for CPU STOP (bit 9) <ul style="list-style-type: none"> • 0: Held • 1: Cleared (8) Link scan mode (bit 10) <ul style="list-style-type: none"> • 0: Sequence scan unsynchronized • 1: Sequence scan synchronized (9) Network topology setting (bit 11) <ul style="list-style-type: none"> • 0: Line topology, star topology, or mixed topology of line and star • 1: Ring topology (10) Output setting for CPU error time (bit 12) <ul style="list-style-type: none"> • 0: Cleared • 1: Held (11) Master station return time operation setting (bit 13) Enabled only when the station type is master. <ul style="list-style-type: none"> • 0: Returning as the master operating station • 1: Returning as the submaster operating station (12) Submaster setting (bit 14) Enabled only when the station type is submaster. <ul style="list-style-type: none"> • 0: Operating with the parameters of the master station • 1: Operating with the parameters of the own, or submaster, station 	0	(12)	(11)	(10)	(9)	(8)	(7)	(6)	0	(5)	(4)	(3)	(2)	(1)	Left	User
0	(12)	(11)	(10)	(9)	(8)	(7)	(6)	0	(5)	(4)	(3)	(2)	(1)					
+2	Total number of slave stations	Sets the total number of slave stations connected.	1 to 121*3	User														

Operand: (s1)						
Device	Item	Description	Setting range ^{*1}	Set by		
+3	Constant link scan time	Sets the constant link scan time. • 0: No operator • 1 to 200: Constant link scan time	0 to 200	User		
+4 +5	IP address	Sets the IPv4 network address (i.e. IP address) when the IP packet transfer function is used. <div style="border: 1px solid black; padding: 5px; display: inline-block;"> <table style="border-collapse: collapse;"> <tr> <td style="border: 1px solid black; padding: 2px;">(s1)+5</td> <td style="border: 1px solid black; padding: 2px;">(s1)+4</td> </tr> </table> </div> (s1)+4: Dummy (s1)+5: Network address	(s1)+5	(s1)+4	0000001H to FFFFFFFFH	User
(s1)+5	(s1)+4					

*1 If a value outside the setting range is set, the instruction will complete with an error.

*2 If "Invalid" is set, the default parameter will be used.

*3 Set value 121 is available only if the submaster function is used.



For the startup in the local station, only Data link faulty station setting (bit 8 of (s1)+1) and Output setting for CPU STOP (bit 9 of (s1)+1) will be valid. Any other changed settings will be ignored during execution of the instruction, without causing an error.

■ Network configuration setting data (for master station setting only)

Operand: (s2)																						
Device	Item	Description	Setting range ^{*1}	Set by																		
+0	For 1st module Slave station setting information	Sets the station type, the number of occupied stations, and the station number. <table style="border-collapse: collapse; margin-left: 20px;"> <tr> <td style="border: none;">b15</td> <td style="border: none;">...</td> <td style="border: none;">b12</td> <td style="border: none;">b11</td> <td style="border: none;">...</td> <td style="border: none;">b8</td> <td style="border: none;">b7</td> <td style="border: none;">...</td> <td style="border: none;">b0</td> </tr> <tr> <td style="border: 1px solid black; padding: 2px;">(3)</td> <td style="border: 1px solid black; padding: 2px;">(2)</td> <td colspan="5"></td> <td style="border: 1px solid black; padding: 2px;">(1)</td> <td></td> </tr> </table> (1) Station number • 1 to 120: Station number • 0: Master station (2) Number of occupied stations • 1: Fixed (3) Station type • 0: Remote I/O station • 1: Remote device station • 2: Intelligent device station • 3: Local station (master-slave system) • 4: Submaster station • F: Master station	b15	...	b12	b11	...	b8	b7	...	b0	(3)	(2)						(1)		Left	User
b15	...	b12	b11	...	b8	b7	...	b0														
(3)	(2)						(1)															
+1	RX/Ry offset	Sets the offset value from the head of RX/Ry (in units of 16 points). ^{*2}	0 to 16368	User																		
+2	Number of RX/Ry points	Sets the number of RX/Ry points. ^{*2} • If the station type is master or local: 0 to 2048 points • If the station type is intelligent device: 0 to 2048 points (in units of 16 points) • If the station type is remote I/O: 0 to 64 points (in units of 16 points) • If the station type is remote device: 0 to 128 points (in units of 16 points)	0 to 2048 0 to 64 0 to 128	User																		
+3	RWr/RWw offset	Sets the offset value from the start of RWr/RWw (in units of 4 points). ^{*2}	0 to 8188	User																		
+4	Number of RWr/RWw points	Sets the number of RWr/RWw points. ^{*2} • If the station type is master or local: 0 to 256 points (in units of 4 points) • If the station type is intelligent device: 0 to 1024 points (in units of 4 points) • If the station type is remote device: 0 to 64 points (in units of 4 points)	0 to 256 0 to 1024 0 to 64	User																		
+5 to +594	:			User																		

Operand: (s2)					
Device	Item	Description	Setting range*1	Set by	
+595	For 120th module	Slave station setting information	Sets the station type.	Same as (s2)+0	User
+596		RX/Ry offset	Sets the offset value from the head of RX/Ry (in units of 16 points). ^{*2}	0 to 16368	User
+597		Number of RX/Ry points	Sets the number of RX/Ry points. ^{*2} • If the station type is master or local: 0 to 2048 points • If the station type is intelligent device: 0 to 2048 points (in units of 16 points) • If the station type is remote I/O: 0 to 64 points (in units of 16 points) • If the station type is remote device: 0 to 128 points (in units of 16 points)	0 to 2048 0 to 64 0 to 128	User
+598		RWr/RWw offset	Sets the offset value from the start of RWr/RWw (in units of 4 points). ^{*2}	0 to 8188	User
+599		Number of RWr/RWw points	Sets the number of RWr/RWw points. ^{*2} • If the station type is master or local: 0 to 256 points (in units of 4 points) • If the station type is intelligent device: 0 to 1024 points (in units of 4 points) • If the station type is remote device: 0 to 64 points (in units of 4 points)	0 to 256 0 to 1024 0 to 64	User
+600 to +604	For 121st module	Same as above		User	

*1 If a value outside the setting range is set for the appropriate station information setting, the instruction will complete with an error.
 *2 The specified number of points is regarded as the number of RX/Ry or RWr/RWw points.
 Set parameters for the total number of slave stations that was set in the control data.

Reserved station setting data (for master station setting only)

Operand: (s3)																																																																																																																																																													
Device	Item	Description	Setting range	Set by																																																																																																																																																									
+0 to +7	Station 1 to 120 specification*1	Specify the reserved station. • 0: Not specified • 1: Specified Each number in the table indicates a station number. <table border="1" style="margin-left: 40px;"> <thead> <tr> <th></th> <th>b15</th><th>b14</th><th>b13</th><th>b12</th><th>b11</th><th>b10</th><th>b9</th><th>b8</th><th>b7</th><th>b6</th><th>b5</th><th>b4</th><th>b3</th><th>b2</th><th>b1</th><th>b0</th> </tr> </thead> <tbody> <tr> <td>(s3)+0</td> <td>16</td><td>15</td><td>14</td><td>13</td><td>12</td><td>11</td><td>10</td><td>9</td><td>8</td><td>7</td><td>6</td><td>5</td><td>4</td><td>3</td><td>2</td><td>1</td> </tr> <tr> <td>(s3)+1</td> <td>32</td><td>31</td><td>30</td><td>29</td><td>28</td><td>27</td><td>26</td><td>25</td><td>24</td><td>23</td><td>22</td><td>21</td><td>20</td><td>19</td><td>18</td><td>17</td> </tr> <tr> <td>(s3)+2</td> <td>48</td><td>47</td><td>46</td><td>45</td><td>44</td><td>43</td><td>42</td><td>41</td><td>40</td><td>39</td><td>38</td><td>37</td><td>36</td><td>35</td><td>34</td><td>33</td> </tr> <tr> <td>(s3)+3</td> <td>64</td><td>63</td><td>62</td><td>61</td><td>60</td><td>59</td><td>58</td><td>57</td><td>56</td><td>55</td><td>54</td><td>53</td><td>52</td><td>51</td><td>50</td><td>49</td> </tr> <tr> <td>(s3)+4</td> <td>80</td><td>79</td><td>78</td><td>77</td><td>76</td><td>75</td><td>74</td><td>73</td><td>72</td><td>71</td><td>70</td><td>69</td><td>68</td><td>67</td><td>66</td><td>65</td> </tr> <tr> <td>(s3)+5</td> <td>96</td><td>95</td><td>94</td><td>93</td><td>92</td><td>91</td><td>90</td><td>89</td><td>88</td><td>87</td><td>86</td><td>85</td><td>84</td><td>83</td><td>82</td><td>81</td> </tr> <tr> <td>(s3)+6</td> <td>112</td><td>111</td><td>110</td><td>109</td><td>108</td><td>107</td><td>106</td><td>105</td><td>104</td><td>103</td><td>102</td><td>101</td><td>100</td><td>99</td><td>98</td><td>97</td> </tr> <tr> <td>(s3)+7</td> <td>—</td><td>—</td><td>—</td><td>—</td><td>—</td><td>—</td><td>—</td><td>—</td><td>120</td><td>119</td><td>118</td><td>117</td><td>116</td><td>115</td><td>114</td><td>113</td> </tr> </tbody> </table> The default parameter specifies that all stations are 0 (not specified).		b15	b14	b13	b12	b11	b10	b9	b8	b7	b6	b5	b4	b3	b2	b1	b0	(s3)+0	16	15	14	13	12	11	10	9	8	7	6	5	4	3	2	1	(s3)+1	32	31	30	29	28	27	26	25	24	23	22	21	20	19	18	17	(s3)+2	48	47	46	45	44	43	42	41	40	39	38	37	36	35	34	33	(s3)+3	64	63	62	61	60	59	58	57	56	55	54	53	52	51	50	49	(s3)+4	80	79	78	77	76	75	74	73	72	71	70	69	68	67	66	65	(s3)+5	96	95	94	93	92	91	90	89	88	87	86	85	84	83	82	81	(s3)+6	112	111	110	109	108	107	106	105	104	103	102	101	100	99	98	97	(s3)+7	—	—	—	—	—	—	—	—	120	119	118	117	116	115	114	113	Left	User
	b15	b14	b13	b12	b11	b10	b9	b8	b7	b6	b5	b4	b3	b2	b1	b0																																																																																																																																													
(s3)+0	16	15	14	13	12	11	10	9	8	7	6	5	4	3	2	1																																																																																																																																													
(s3)+1	32	31	30	29	28	27	26	25	24	23	22	21	20	19	18	17																																																																																																																																													
(s3)+2	48	47	46	45	44	43	42	41	40	39	38	37	36	35	34	33																																																																																																																																													
(s3)+3	64	63	62	61	60	59	58	57	56	55	54	53	52	51	50	49																																																																																																																																													
(s3)+4	80	79	78	77	76	75	74	73	72	71	70	69	68	67	66	65																																																																																																																																													
(s3)+5	96	95	94	93	92	91	90	89	88	87	86	85	84	83	82	81																																																																																																																																													
(s3)+6	112	111	110	109	108	107	106	105	104	103	102	101	100	99	98	97																																																																																																																																													
(s3)+7	—	—	—	—	—	—	—	—	120	119	118	117	116	115	114	113																																																																																																																																													

*1 Make the setting for the station number that was set with the appropriate setting information setting data.

Point

If the specified total number of slave stations does not match the individual station setting data, the total number of individual stations specified in the total number of slave stations take precedence. Individual station information which is specified exceeding the total number of slave stations is ignored. Note that 1 is added to the total number of slave stations when the submaster function enabled/disabled ((s1)+1 bit 3) is enabled (1).

■ Error invalid station setting data (for master station setting only)

Operand: (s4)																																																																																																																																																													
Device	Item	Description	Setting range	Set by																																																																																																																																																									
+0 to +7	Station 1 to 120 specification *1	Specify the error invalid station. • 0: Not specified • 1: Specified Each number in the table indicates a station number.	Left	User																																																																																																																																																									
		<table border="1"> <thead> <tr> <th></th> <th>b15</th> <th>b14</th> <th>b13</th> <th>b12</th> <th>b11</th> <th>b10</th> <th>b9</th> <th>b8</th> <th>b7</th> <th>b6</th> <th>b5</th> <th>b4</th> <th>b3</th> <th>b2</th> <th>b1</th> <th>b0</th> </tr> </thead> <tbody> <tr> <td>(s4)+0</td> <td>16</td> <td>15</td> <td>14</td> <td>13</td> <td>12</td> <td>11</td> <td>10</td> <td>9</td> <td>8</td> <td>7</td> <td>6</td> <td>5</td> <td>4</td> <td>3</td> <td>2</td> <td>1</td> </tr> <tr> <td>(s4)+1</td> <td>32</td> <td>31</td> <td>30</td> <td>29</td> <td>28</td> <td>27</td> <td>26</td> <td>25</td> <td>24</td> <td>23</td> <td>22</td> <td>21</td> <td>20</td> <td>19</td> <td>18</td> <td>17</td> </tr> <tr> <td>(s4)+2</td> <td>48</td> <td>47</td> <td>46</td> <td>45</td> <td>44</td> <td>43</td> <td>42</td> <td>41</td> <td>40</td> <td>39</td> <td>38</td> <td>37</td> <td>36</td> <td>35</td> <td>34</td> <td>33</td> </tr> <tr> <td>(s4)+3</td> <td>64</td> <td>63</td> <td>62</td> <td>61</td> <td>60</td> <td>59</td> <td>58</td> <td>57</td> <td>56</td> <td>55</td> <td>54</td> <td>53</td> <td>52</td> <td>51</td> <td>50</td> <td>49</td> </tr> <tr> <td>(s4)+4</td> <td>80</td> <td>79</td> <td>78</td> <td>77</td> <td>76</td> <td>75</td> <td>74</td> <td>73</td> <td>72</td> <td>71</td> <td>70</td> <td>69</td> <td>68</td> <td>67</td> <td>66</td> <td>65</td> </tr> <tr> <td>(s4)+5</td> <td>96</td> <td>95</td> <td>94</td> <td>93</td> <td>92</td> <td>91</td> <td>90</td> <td>89</td> <td>88</td> <td>87</td> <td>86</td> <td>85</td> <td>84</td> <td>83</td> <td>82</td> <td>81</td> </tr> <tr> <td>(s4)+6</td> <td>112</td> <td>111</td> <td>110</td> <td>109</td> <td>108</td> <td>107</td> <td>106</td> <td>105</td> <td>104</td> <td>103</td> <td>102</td> <td>101</td> <td>100</td> <td>99</td> <td>98</td> <td>97</td> </tr> <tr> <td>(s4)+7</td> <td>—</td> <td>—</td> <td>—</td> <td>—</td> <td>—</td> <td>—</td> <td>—</td> <td>—</td> <td>120</td> <td>119</td> <td>118</td> <td>117</td> <td>116</td> <td>115</td> <td>114</td> <td>113</td> </tr> </tbody> </table>		b15	b14	b13	b12	b11	b10	b9	b8	b7	b6	b5	b4	b3	b2	b1	b0	(s4)+0	16	15	14	13	12	11	10	9	8	7	6	5	4	3	2	1	(s4)+1	32	31	30	29	28	27	26	25	24	23	22	21	20	19	18	17	(s4)+2	48	47	46	45	44	43	42	41	40	39	38	37	36	35	34	33	(s4)+3	64	63	62	61	60	59	58	57	56	55	54	53	52	51	50	49	(s4)+4	80	79	78	77	76	75	74	73	72	71	70	69	68	67	66	65	(s4)+5	96	95	94	93	92	91	90	89	88	87	86	85	84	83	82	81	(s4)+6	112	111	110	109	108	107	106	105	104	103	102	101	100	99	98	97	(s4)+7	—	—	—	—	—	—	—	—	120	119	118	117	116	115	114	113		
	b15	b14	b13	b12	b11	b10	b9	b8	b7	b6	b5	b4	b3	b2	b1	b0																																																																																																																																													
(s4)+0	16	15	14	13	12	11	10	9	8	7	6	5	4	3	2	1																																																																																																																																													
(s4)+1	32	31	30	29	28	27	26	25	24	23	22	21	20	19	18	17																																																																																																																																													
(s4)+2	48	47	46	45	44	43	42	41	40	39	38	37	36	35	34	33																																																																																																																																													
(s4)+3	64	63	62	61	60	59	58	57	56	55	54	53	52	51	50	49																																																																																																																																													
(s4)+4	80	79	78	77	76	75	74	73	72	71	70	69	68	67	66	65																																																																																																																																													
(s4)+5	96	95	94	93	92	91	90	89	88	87	86	85	84	83	82	81																																																																																																																																													
(s4)+6	112	111	110	109	108	107	106	105	104	103	102	101	100	99	98	97																																																																																																																																													
(s4)+7	—	—	—	—	—	—	—	—	120	119	118	117	116	115	114	113																																																																																																																																													
		The default parameter specifies that all stations are 0 (not specified).																																																																																																																																																											

*1 Make the setting for the station number that was set with the appropriate setting information setting data.
 If both the error invalid and reserved stations are specified for the same station, the reserved station setting will take priority.

Point

Any station numbers outside the range specified by the total number of slave stations or other than those specified in the individual station information settings are ignored even if they are specified as reserved stations or temporary error invalid stations. For instance, assume that station No.3 and station No.4 are specified as reserved stations with items set as follows: total number of slave stations = 2, information for 1st module = station No.1, information for 2nd module = station No.2, information for 3rd module = station No.3, information for 4th module = station No.4. Since parameters become valid for information of the 1st and 2nd modules only, the reserved station settings for station No.3 and station No.4 are ignored. (In this case, when the total number of slave stations is changed to 4, the reserved station settings for station No.3 and station No.4 become valid.)

Processing details

- This instruction sets the parameters in the CC-Link IE Field Network master and local modules.

[Own station]

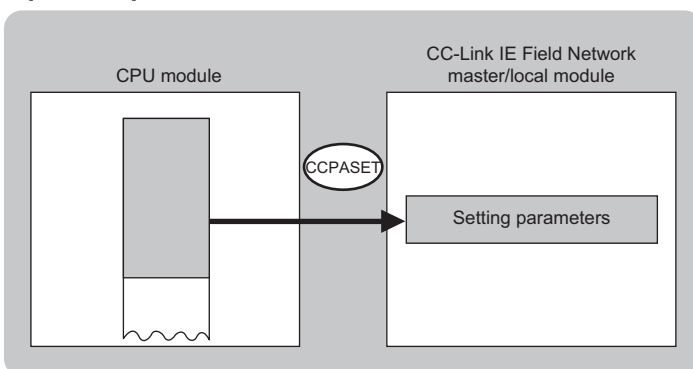

- The execution status and the completion status of the G(P).CCPASET instruction can be checked with the completion device (d) and the completion status indication device (d)+1.

- Completion device (d)

This device turns on during END processing of the scan where the G(P).CCPASET instruction completes, and turns off during the next END processing.

- Completion status indication device (d)+1

This device turns on or off depending on the completion status of the G(P).CCPASET instruction.

When completed successfully: The device remains off.

When completed with an error: The device turns on during END processing of the scan where the G(P).CCPASET instruction completes, and turns off during the next END processing.

- The following figure shows the operation at completion of the G(P).CCPASET instruction.
- When completed successfully

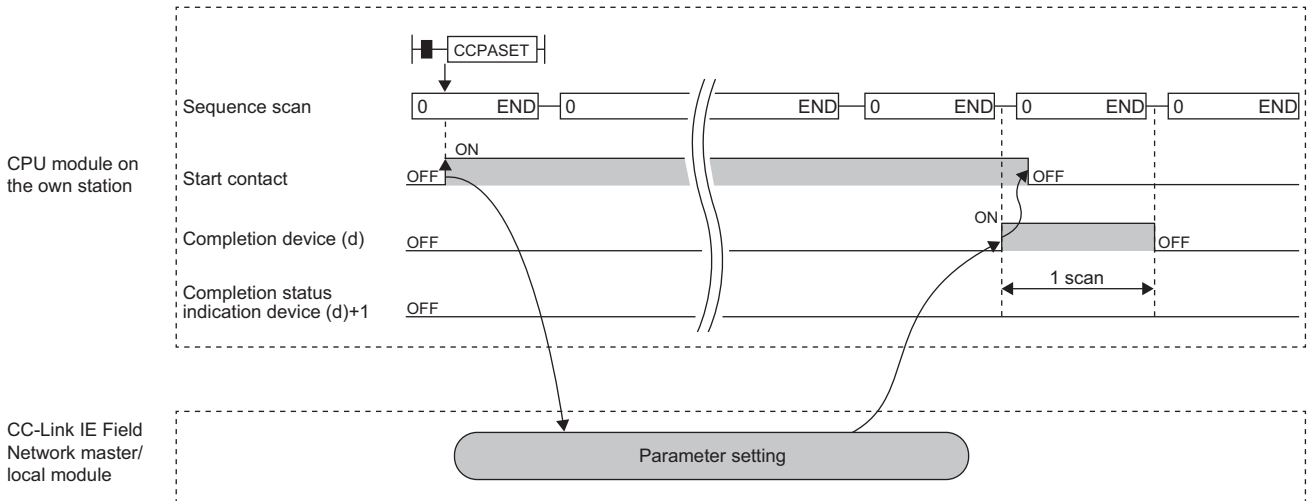

- When completed with an error

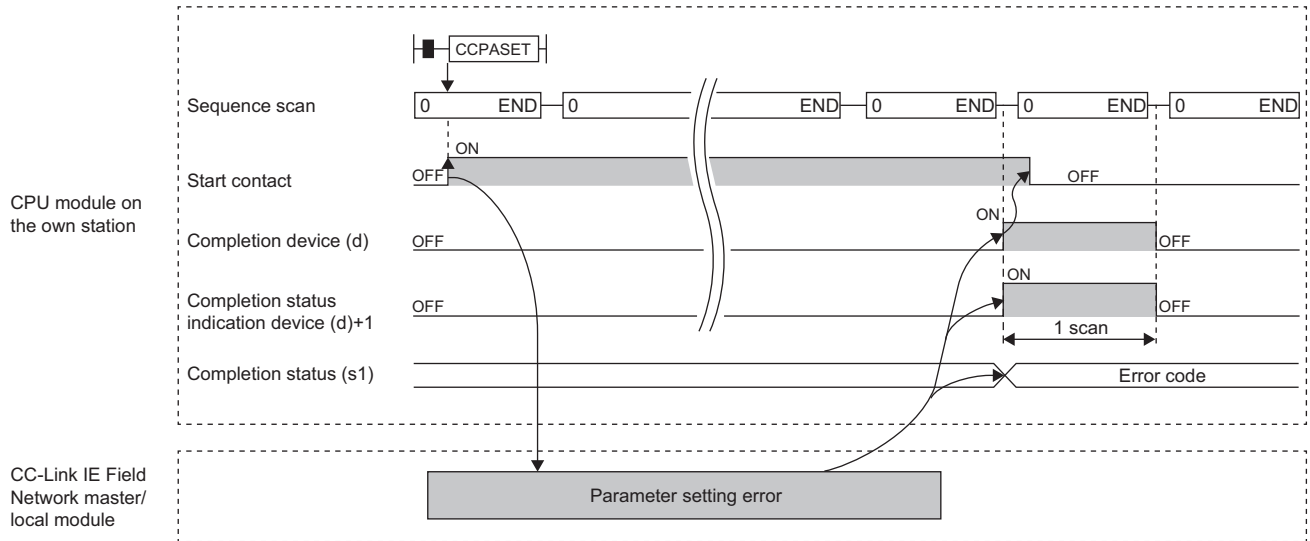

Operation error

Error code ((s1)+0)	Description
D000H to DFFFH	MELSEC iQ-R CC-Link IE Field Network User's Manual (Application)

7.8 Setting the Station Number to Own Station

G(P).UINI, Z(P).UINI



These instructions set the station number for the local, or own, station whose station number has not yet been set.

Ladder	ST
	<pre> ENO:=G_UINI(EN,U,s,d); ENO:=GP_UINI(EN,U,s,d); ENO:=Z_UINI(EN,U,s,d); ENO:=ZP_UINI(EN,U,s,d); </pre>

FBD/LD

Execution condition

Instruction	Execution condition
G.UINI Z.UINI	
GP.UINI ZP.UINI	

Setting data

Description, range, data type

Operand	Description	Range	Data type	Data type (label)
(U)	G(P).UINI Start I/O number (first three digits in four-digit hexadecimal representation) of own station or own node	00H to FEH	16-bit unsigned binary	ANY16
	Z(P).UINI Start I/O number (first three digits in four-digit hexadecimal representation) of own station or own node	00H to FEH	String	ANY16_OR_STRING_SINGLE
(s)	Own station start device where control data is stored	Refer to the control data.	Device name	ANY16 ^{*1}
(d)	Device of the own station, which turns on for one scan upon completion of the instruction. When the instruction completes with an error, (d)+1 also turns on.	—	Bit	ANYBIT_ARRAY (Number of elements: 2)
EN	Execution condition	—	Bit	BOOL
ENO	Execution result	—	Bit	BOOL

*1 When specifying setting data by using a label, define an array to secure enough operation area and specify an element of the array label.

■Applicable devices

Operand		Bit		Word			Double word		Indirect specification	Constant			Others (U)
		X, Y, M, L, SM, F, B, SB, FX, FY	J□□□	T, ST, C, D, W, SD, SW, FD, R, ZR, RD	U□□G□, J□□□, U3E□□(H)G□	Z	LT, LST, LC	LZ		K, H	E	\$	
(U)	G(P).UINI	—	—	○	—	—	—	—	○	○	—	—	○
	Z(P).UINI	—	—	○	—	—	—	—	○	—	—	○	○
(s)		—	—	○*2	—	—	—	—	○	—	—	—	—
(d)		○*1	—	○*3	—	—	—	—	—	—	—	—	—

*1 FX and FY cannot be used.

*2 FD cannot be used.

*3 T, ST, C, and FD cannot be used.

■Control data

Operand: (s)				
Device	Item	Description	Setting range	Set by
+0	—	Not used	—	System
+1	Completion status	The instruction completion status is stored. • 0: Normal • Other than 0: Error (error code)	—	System
+2	Change target specification	0001H (fixed)	0001H	User
+3	Station number of own station	Specifies the station number to be set.	1 to 120	User
+4 to +9	—	Not used	—	System

Point

- The UINI instruction can be executed only once.
- If the UINI instruction is issued after the station number has been determined, it will complete with an error.
- If the UINI instruction completes with an error before the station number is determined, take corrective action to correct the error content before retrying to execute the instruction.

Processing details

- Sets the station number for the local station.

[Own station]

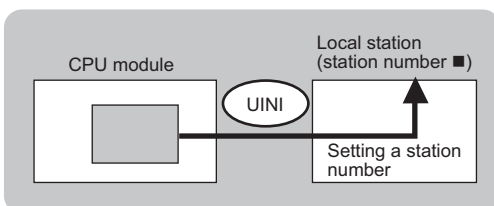

- The execution status and the completion status of the UINI instruction can be checked with the completion device (d) and the completion status indication device (d)+1.

- Completion device (d)

This device turns on during END processing of the scan where the UINI instruction completes, and turns off during the next END processing.

- Completion status indication device (d)+1

This device turns on or off depending on the completion status of the UINI instruction.

When completed successfully: The device remains off.

When completed with an error: The device turns on during END processing of the scan where the UINI instruction completes, and turns off during the next END processing.

- The following figure shows the operation at completion of the UINI instruction.
- When completed successfully

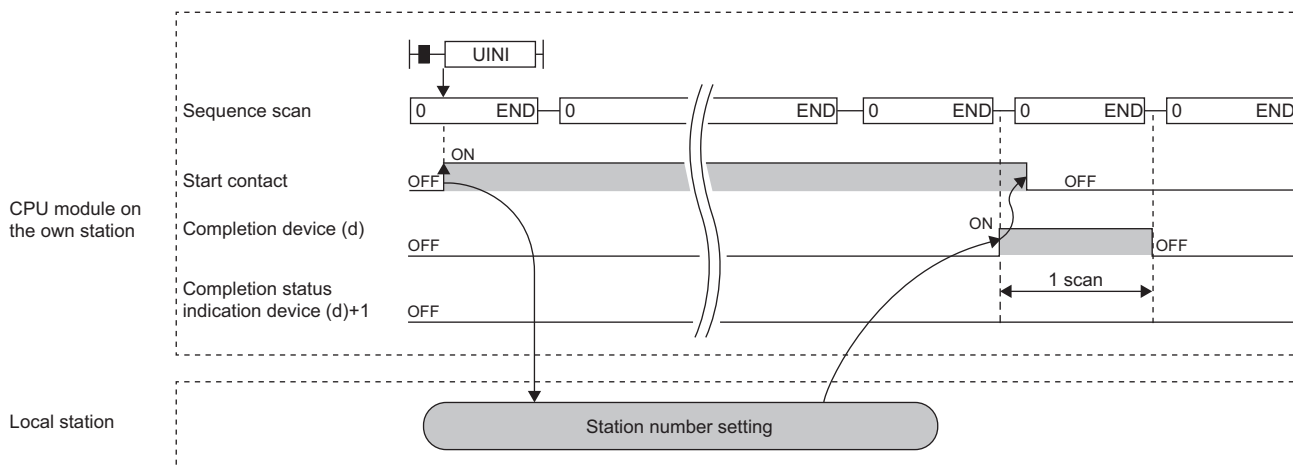

- When completed with an error

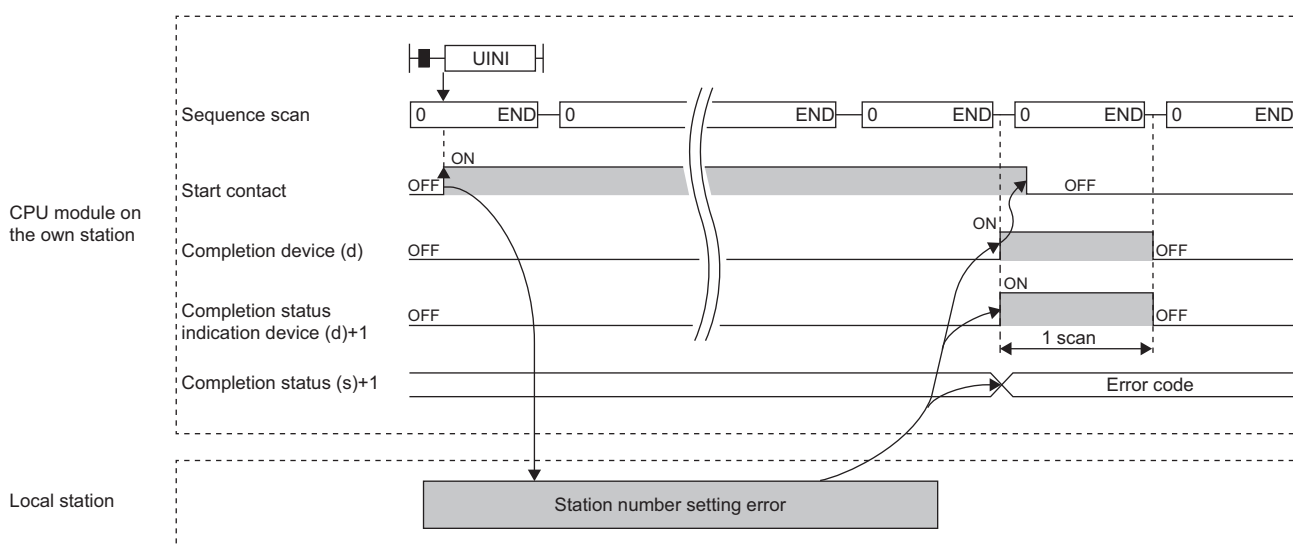

Operation error

Error code ((s)+1)	Description
D000H to DFFFH	MELSEC IQ-R CC-Link IE Field Network User's Manual (Application)

7.9 Sending an SLMP Frame

J(P).SLMPREQ, G(P).SLMPREQ

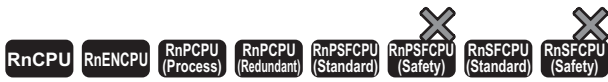

• The RnENCPU (network part), RJ71GF11-T2, and RJ71EN71 with firmware version "18" or later support these instructions. Use an engineering tool with version "1.035M" or later.

These instructions send an SLMP frame to the SLMP-compatible device in the same network. Data of the target station can be read/written and operated.

Ladder	ST
	<pre>ENO:=J_SLMPREQ(EN,J,s1,s2,d1,d2); ENO:=JP_SLMPREQ(EN,J,s1,s2,d1,d2); ENO:=G_SLMPREQ(EN,U,s1,s2,d1,d2); ENO:=GP_SLMPREQ(EN,U,s1,s2,d1,d2);</pre>

FBD/LD

Execution condition

Instruction	Execution condition
J.SLMPREQ G.SLMPREQ	
JP.SLMPREQ GP.SLMPREQ	

Setting data

Description, range, data type

Operand	Description	Range	Data type	Data type (label)	
(J/U)	J(P).SLMPREQ	(J): Own station network number	1 to 239	16-bit unsigned binary	ANY16
	G(P).SLMPREQ	(U): Start I/O number (first three digits in four-digit hexadecimal representation) of own station or own node	00H to FEH	16-bit unsigned binary	ANY16
(s1)	Own station start device where control data is stored	Refer to the control data.	Device name	ANY16 ^{*1}	
(s2)	Own station start device where request data is stored	—	Device name	ANY16 ^{*1}	
(d1)	Own station start device for storing response data	—	Device name	ANY16 ^{*1}	
(d2)	Device of the own station, which turns on for one scan upon completion of the instruction. When the instruction completes with an error, (d2)+1 also turns on.	—	Bit	ANYBIT_ARRAY (Number of elements: 2)	
EN	Execution condition	—	Bit	BOOL	
ENO	Execution result	—	Bit	BOOL	

*1 When specifying setting data by using a label, define an array to secure enough operation area and specify an element of the array label.

■Applicable devices

Operand		Bit		Word			Double word		Indirect specification	Constant			Others	
		X, Y, M, L, SM, F, B, SB, FX, FY	J□□	T, ST, C, D, W, SD, SW, FD, R, ZR, RD	U□□□, J□□□, U3E□□(H)G□	Z	LT, LST, LC	LZ		K, H, E, \$	J, U			
(J/U)	J(P).SLMPR EQ	—	—	—	—	—	—	—	—	—	—	—	○	—
	G(P).SLMPR EQ	—	—	○	—	—	—	—	○	○	—	—	—	○
(s1)		—	—	○*2	—	—	—	—	○	—	—	—	—	—
(s2)		—	—	○*2	—	—	—	—	○	—	—	—	—	—
(d1)		—	—	○*2	—	—	—	—	○	—	—	—	—	—
(d2)		○*1	—	○*3	—	—	—	—	—	—	—	—	—	—

*1 FX and FY cannot be used.

*2 FD cannot be used.

*3 T, ST, C, and FD cannot be used.

■Control data

Operand: (s1)				
Device	Item	Description	Setting range	Set by
+0	Error completion type	<div style="display: flex; justify-content: space-between; align-items: center;"> b15 ... b7 ... b0 </div> <div style="border: 1px solid black; padding: 2px; margin-top: 5px;"> (2) 0 (1) 0 </div> <p>(1)Error completion type (bit 7) Specify whether to set clock data when completed with an error.</p> <ul style="list-style-type: none"> • 0: Clock data at error occurrence is not stored in (s1)+12 and later. • 1: Clock data at error occurrence is stored in (s1)+12 and later. 	0000H 0080H	User
+1	Completion status	The instruction completion status is stored.	—	System
+2	Not used	—	—	—
+3	Request destination module I/O number	Specify an access target module.	03FFH	User
+4	Request destination network number	Specify an access target network number.	1 to 239	User
+5	Request destination station number	Specify an access target station number.	1 to 120, 125, 126	User
+6	Not used	—	—	—
+7	Number of resends	<p>■Before instruction execution Specify the number of resends to be performed if the instruction is not completed within the monitoring time specified by (s1)+8.</p> <ul style="list-style-type: none"> • 0 to 15 times <p>■At completion of instruction The number of resends performed (result) is stored.</p> <ul style="list-style-type: none"> • 0 to 15 times 	0 to 15	User/ system
+8	Arrival monitoring time	Specify the monitoring time until completion of processing. If processing is not completed within the monitoring time, the request is resent by the number of resends specified in (s1)+7.	0 to 32767	User
+9	Request data length	Specify the data size of the request data to be specified by (s2) in bytes. The request data includes (s2)+0 (not used).	6 to 1964	User
+10	Response data length	The data size of the response data to be stored in (d1) is stored in bytes. The response data includes (d1)+0 (end code).	—	System
+11	Clock setting flag	The validity status (valid or invalid) of the data in (s1)+12 and later is stored. Note that the data in (s1)+12 and later is not cleared even when the instruction is completed successfully.	—	System

Operand: (s1)				
Device	Item	Description	Setting range	Set by
+12	Clock data (Set only in an abnormal state)	Upper 8 bits: Month (01H to 12H) Lower 8 bits: Year (00H to 99H: Lower two digits of the year)	—	System
+13		Upper 8 bits: Hour (00H to 23H) Lower 8 bits: Day (01H to 31H)	—	System
+14		Upper 8 bits: Second (00H to 59H) Lower 8 bits: Minute (00H to 59H)	—	System
+15		Upper 8 bits: Year (00H to 99H: Upper two digits of the year) Lower 8 bits: Day of the week (00H (Sun.) to 06H (Sat.))	—	System
+16	Error detection network number	The network number of the station in which an error was detected is stored. • 1 to 239 (Network number)	—	System
+17	Error-detected station number	The number of the station where an error was detected is stored. • 1 to 120: Local station, intelligent device station, remote device station, submaster station • 125: Master station • 126: Master operating station	—	System

Request data

Operand: (s2)				
Device	Item	Description	Setting range	Set by
+0	Not used	—	—	—
+1	Command	Sets the command of the SLMP frame.*1	Refer to the manual of the target station.	User
+2	Subcommand	Sets the subcommand of the SLMP frame.*1		User
+3 to +□	SLMP frame data	Stores the SLMP frame data after the subcommand.*1		User

*1 For details on the SLMP frame, refer to the following.

 SLMP Reference Manual

Response data

Operand: (d1)				
Device	Item	Description	Setting range	Set by
+0	End code	Stores the result of command processing. In normal end, 0 is stored. In abnormal end, an error code set by the external device is stored.	—	System
+1 to +□	Response data	Sets execution results for the request data. (Some commands do not return response data.)	—	System

Processing details

- These instructions send the request data in the device specified by (s2) or later to the target station specified with the control data. When a response message is received from the target station, it is stored in the device specified by (d1).
- The J(P).SLMPREQ and G(P).SLMPREQ instructions communicate in binary code.
- A serial number is automatically set to the subheader.

■Message format

The following figures show the request data and the response data in normal/abnormal end.

- Request message

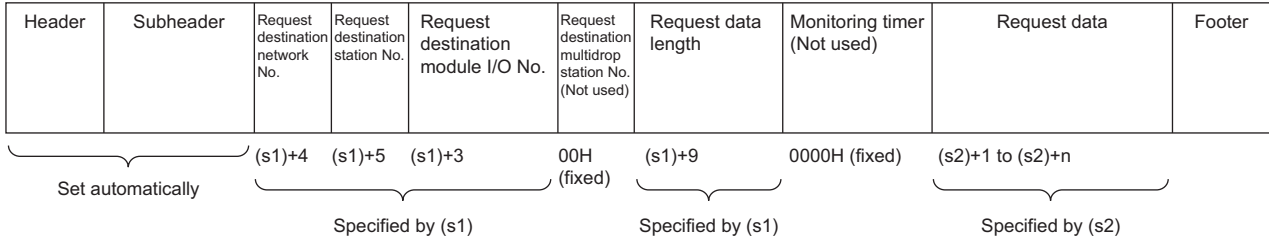

- Response message

(when completed normally)

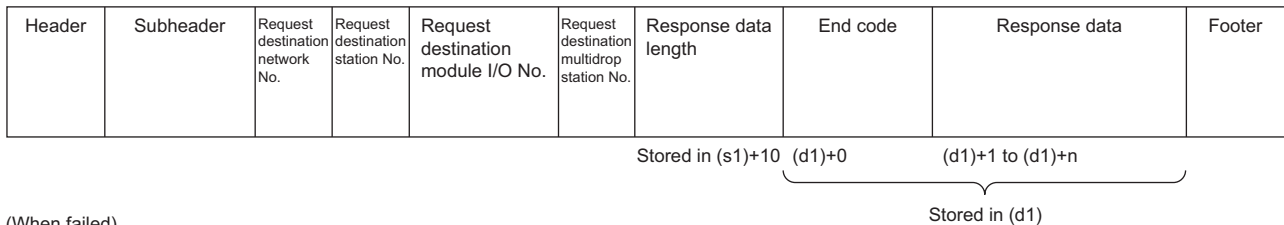

(When failed)

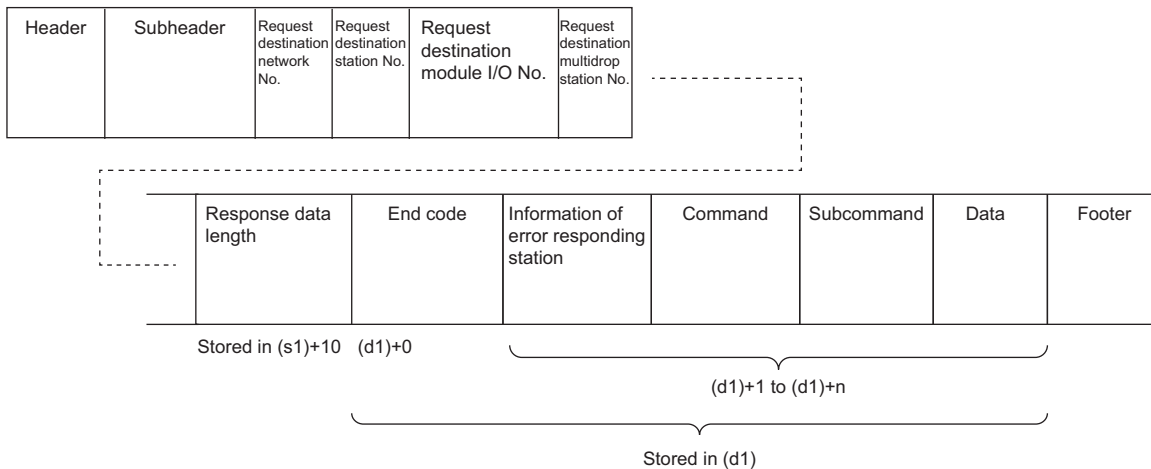

The network number, station number, request destination module I/O number, and multidrop station number are stored to the information of the error responding station.

Ex.

Sending "Read (command: 0401H)" (read in units of words) which reads the value in D100 to D102

- Request message

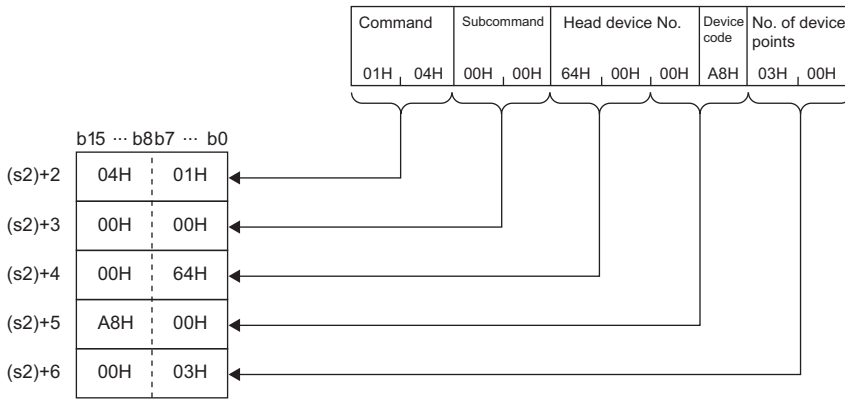

- Response message

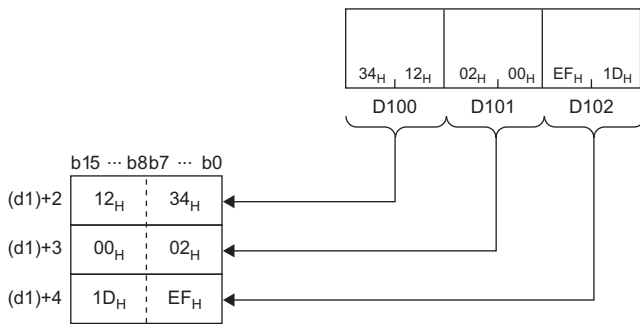

Operation error

Error code (SW0080 to SW009F)	Description
4000H to 4FFFH	📖 MELSEC iQ-R CPU Module User's Manual (Application)
D000H to DFFFH	📖 MELSEC iQ-R CC-Link IE Field Network User's Manual (Application)

Precautions

Stations in other networks cannot be set as target stations. (Access via a relay station is not allowed.)

8 CC-Link INSTRUCTIONS

Point

This chapter describes the instructions used commonly by MELSEC iQ-R series modules. For the instructions when MELSEC-Q series modules are used, refer to the manuals for each module used and create programs. For precautions when using modules, refer to the following.

MELSEC iQ-R Module Configuration Manual

8.1 Reading Data from the Target Station

G(P).RIRD



These instructions read data of the specified number of points from the buffer memory area of the target station or the device of its CPU module.

Ladder	ST
	<pre>ENO:=G_RIRD(EN,U,s,d1,d2); ENO:=GP_RIRD(EN,U,s,d1,d2);</pre>

FBD/LD

Execution condition

Instruction	Execution condition
G.RIRD	
GP.RIRD	

Setting data

Description, range, data type

Operand	Description	Range	Data type	Data type (label)
(U)	Start I/O number (first three digits in four-digit hexadecimal representation) of a module	00H to FEH	16-bit unsigned binary	ANY16
(s)	Start device where control data is stored	Refer to the control data.	Device name	ANY16 ^{*1}
(d1)	Start device for storing the read data	—	Device name	ANY16 ^{*1}
(d2)	Device that turns on for one scan upon completion of the instruction When the instruction completes with an error, (d2)+1 also turns on.	—	Bit	ANYBIT_ARRAY (Number of elements: 2)
EN	Execution condition	—	Bit	BOOL
ENO	Execution result	—	Bit	BOOL

*1 When specifying setting data by using a label, define an array to secure enough operation area and specify an element of the array label.

■Applicable devices

Operand	Bit		Word				Double word		Indirect specification	Constant			Others (U)
	X, Y, M, L, SM, F, B, SB, FX, FY	J□□	T, ST, C, D, W, SD, SW, FD, R, ZR, RD	U□V□, J□□, U3E□(H)□	Z	LT, LST, LC	LZ	K, H		E	\$		
(U) ^{*1}	—	—	○	—	—	—	—	○	○	—	—	○	
(s)	—	—	○ ^{*3}	—	—	—	—	○	—	—	—	—	
(d1)	—	—	○ ^{*3}	—	—	—	—	○	—	—	—	—	
(d2)	○ ^{*2}	—	○ ^{*4}	—	—	—	—	—	—	—	—	—	

*1 Index modification is not available.

*2 FX and FY cannot be used.

*3 FD cannot be used.

*4 T, ST, C, and FD cannot be used.

■Control data

Operand: (s)				
Device	Item	Description	Setting range	Set by
+0	Completion status	The completion status is stored upon completion of the instruction. • 0: Completed successfully • Other than 0: Completed with an error (error code)	—	System
+1	Station number	Specify the station number of the target station.	0 to 64	User
+2	Access/attribute code	Specifies the type of the buffer memory or device from which to read data. <div style="display: flex; align-items: center; gap: 20px;"> b15 ... b8 b7 ... b0 </div> <div style="border: 1px solid black; width: 150px; height: 15px; margin: 5px auto;"></div> <ul style="list-style-type: none"> • b8 to b15: Access code • b0 to b7: Attribute code 	Refer to "Access/attribute code."	User
+3	Buffer memory address or device number	Specifies the start address of the buffer memory or the start device from which to read data.	Refer to the manual of the target station. ^{*1}	User
+4	Number of read points	Specifies, in units of words, the number of points to be read.	1 to 480 ^{*2} 1 to 32 ^{*3}	User

*1 When specifying a random accuracy buffer, specify the address with the start of the random accuracy buffer defined as 0.

*2 Specify a value within the capacity of the target station buffer memory area or device.

*3 If data is to be read from a CPU module device if the target station CPU module is other than RCP, QCPU (Q mode), QCPU (A mode), LCP, QnACP, or AnUCP, the setting range is 1 to 32 words.

■ Access/attribute code

- When data is read from the buffer memory within the CC-Link module

Contents of buffer memory		Access code	Attribute code
Buffer in intelligent device		00H	04H
Buffer in master, local, or standby master station	Random access buffer	20H	04H
	Remote input	21H	04H
	Remote output	22H	04H
	Remote register	24H	04H
	Link special relay	63H	04H
	Link special register	64H	04H

- When data is read from a CPU module device

Device category ^{*1}	Name	Date type		Unit	Access code	Attribute code
		Bit	Word			
Input relay	X	○	—	Hexadecimal	01H	05H
Output relay	Y	○	—	Hexadecimal	02H	05H
Internal relay	M	○	—	Decimal	03H	05H
Latch relay	L	○	—	Decimal	83H	05H
Link relay	B	○	—	Hexadecimal	23H	05H
Timer (contact)	T	○	—	Decimal	09H	05H
Timer (coil)	T	○	—	Decimal	0AH	05H
Timer (current value)	T	—	○	Decimal	0CH	05H
Retentive timer (contact)	ST	○	—	Decimal	89H	05H
Retentive timer (coil)	ST	○	—	Decimal	8AH	05H
Retentive timer (current value)	ST	—	○	Decimal	8CH	05H
Counter (contact)	C	○	—	Decimal	11H	05H
Counter (coil)	C	○	—	Decimal	12H	05H
Counter (current value)	C	—	○	Decimal	14H	05H
Data register ^{*2}	D	—	○	Decimal	04H	05H
Link register ^{*2}	W	—	○	Hexadecimal	24H	05H
File register	R	—	○	Decimal	84H	05H
Link special relay	SB	○	—	Hexadecimal	63H	05H
Link special register	SW	—	○	Hexadecimal	64H	05H
Special relay	SM	○	—	Decimal	43H	05H
Special register	SD	—	○	Decimal	44H	05H

*1 Only the above devices can be specified. To read data from a bit device, specify it with 0 or a multiple of 16.

*2 D65536 and the subsequent extended data registers and of W10000 and the subsequent extended link registers cannot be specified.

Processing details

- This instruction reads data of the specified number of points from the buffer memory area of the target station or the device of its CPU module.
- From the master station, the instruction can be executed for the local, standby master, or intelligent device station. From the local or standby master station, the instruction can be executed for the master, local, or standby master station.
- The following figure shows how the G(P).RIRD instruction operates during execution.

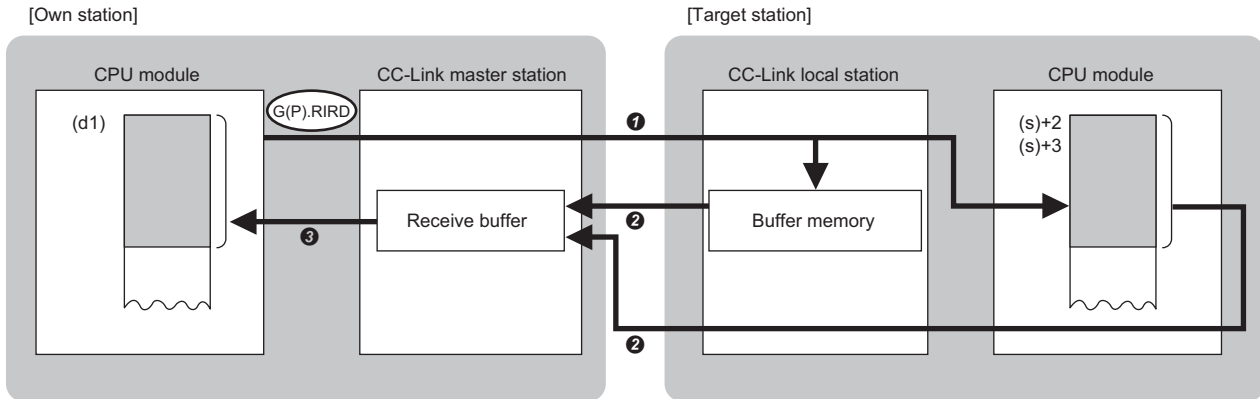

- ➊ Data is read from the buffer memory area specified by (s)+2 and (s)+3 that is included in the station specified by (s)+1 or from the device of the CPU module.
- ➋ The read data is stored in the receive buffer of the master station.
- ➌ The read data is stored in the device specified by (d1) and later, and the device specified by (d2) is turned on.

- The completion status of the G(P).RIRD instruction can be checked with the completion device (d2) and the completion status indication device (d2)+1.

- Completion device (d2)

This device turns on during END processing of the scan where the G(P).RIRD instruction completes, and turns off during the next END processing.

- Completion status indication device (d2)+1

This device turns on or off depending on the completion status of the G(P).RIRD instruction.

When completed successfully: The device remains off.

When completed with an error: The device turns on during END processing of the scan where the G(P).RIRD instruction completes, and turns off during the next END processing.

Precautions

- The monitoring time and the number of retries can be set with the following link special registers (SWs).
 - Monitoring time setting (SW0009)
 - Setting of the number of retries for dedicated instruction (SW000B)
- The G(P).RIRD instruction can be concurrently executed from the master station for two or more local, standby master, or intelligent device stations. Two or more dedicated instructions cannot be concurrently executed for a single station. Two or more dedicated instructions, including those other than G(P).RIRD, cannot be concurrently executed from a local station even for another station. If the next dedicated instruction is issued before completion of the preceding one that has started, the next one will be ignored. Create the program so that the next dedicated instruction will start after the completion device turns on, because processing of a dedicated instruction takes several scans until its completion.

Operation error

Error code ((s)+0)	Description
4000H to 4FFFH	MELSEC iQ-R CPU Module User's Manual (Application)
B000H to BFFFH	MELSEC iQ-R CC-Link System Master/Local Module User's Manual (Application)

8.2 Writing Data to the Target Station

G(P).RIWT

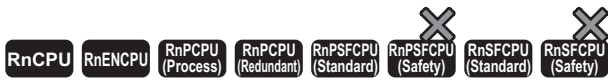

These instructions write data of the specified number of points to the buffer memory area of the target station or the device of its CPU module.

Ladder	ST
	<pre>ENO:=G_RIWT(EN,U,s1,s2,d); ENO:=GP_RIWT(EN,U,s1,s2,d);</pre>

FBD/LD

Execution condition

Instruction	Execution condition
G.RIWT	
GP.RIWT	

Setting data

Description, range, data type

Operand	Description	Range	Data type	Data type (label)
(U)	Start I/O number (first three digits in four-digit hexadecimal representation) of a module	00H to FEH	16-bit unsigned binary	ANY16
(s1)	Start device where control data is stored	Refer to the control data.	Device name	ANY16 ^{*1}
(s2)	Start device for storing the data to be written	—	Device name	ANY16 ^{*1}
(d)	Device that turns on for one scan upon completion of the instruction When the instruction completes with an error, (d)+1 also turns on.	—	Bit	ANYBIT_ARRAY (Number of elements: 2)
EN	Execution condition	—	Bit	BOOL
ENO	Execution result	—	Bit	BOOL

*1 When specifying setting data by using a label, define an array to secure enough operation area and specify an element of the array label.

■Applicable devices

Operand	Bit		Word			Double word		Indirect specification	Constant			Others (U)
	X, Y, M, L, SM, F, B, SB, FX, FY	J□□	T, ST, C, D, W, SD, SW, FD, R, ZR, RD	U□V□, J□□, U3E□(H)G□	Z	LT, LST, LC	LZ		K, H	E	\$	
(U) ^{*1}	—	—	○	—	—	—	○	○	—	—	○	
(s1)	—	—	○ ^{*3}	—	—	—	○	—	—	—	—	
(s2)	—	—	○ ^{*3}	—	—	—	○	—	—	—	—	
(d)	○ ^{*2}	—	○ ^{*4}	—	—	—	—	—	—	—	—	

*1 Index modification is not available.

*2 FX and FY cannot be used.

*3 FD cannot be used.

*4 T, ST, C, and FD cannot be used.

■Control data

Operand: (s1)				
Device	Item	Description	Setting range	Set by
+0	Completion status	The completion status is stored upon completion of the instruction. • 0: Completed successfully • Other than 0: Completed with an error (error code)	—	System
+1	Station number	Specify the station number of the target station.	0 to 64	User
+2	Access/attribute code	Specifies the type of the buffer memory or device from which to read data. <div style="display: flex; align-items: center; gap: 10px;"> b15 ... b8 b7 ... b0 </div> <div style="border: 1px solid black; width: 100px; height: 15px; margin: 5px 0;"></div> <ul style="list-style-type: none"> • b8 to b15: Access code • b0 to b7: Attribute code 	Refer to "Access/attribute code."	User
+3	Buffer memory address or device number	Specifies the start address of the buffer memory area or the start device where to write data.	Refer to the manual of the target station. ^{*1}	User
+4	Number of write points	Specifies, in units of words, the number of points to be written.	1 to 480 ^{*2} 1 to 32 ^{*3}	User

*1 When specifying a random accuracy buffer, specify the address with the start of the random accuracy buffer defined as 0.

*2 Specify a value within the capacity of the target station buffer memory area or device.

*3 If data is to be written to a CPU module device if the target station CPU module is other than RCP, QCPU (Q mode), QCPU (A mode), LCP, QnACP, or AnUCP, the setting range is 1 to 32 words.

■ Access/attribute code

- When data is written to the buffer memory within the CC-Link module

Contents of buffer memory		Access code	Attribute code
Buffer in intelligent device		00H	04H
Buffer in master or local station	Random access buffer	20H	04H
	Remote input	21H	04H
	Remote output	22H	04H
	Remote register	24H	04H
	Link special relay	63H	04H
	Link special register	64H	04H

- When data is written to the device of the CPU module

Device category ^{*1}	Name	Date type		Unit	Access code	Attribute code
		Bit	Word			
Input relay	X	○	—	Hexadecimal	01H	05H
Output relay	Y	○	—	Hexadecimal	02H	05H
Internal relay	M	○	—	Decimal	03H	05H
Latch relay	L	○	—	Decimal	83H	05H
Link relay	B	○	—	Hexadecimal	23H	05H
Timer (contact)	T	○	—	Decimal	09H	05H
Timer (coil)	T	○	—	Decimal	0AH	05H
Timer (current value)	T	—	○	Decimal	0CH	05H
Retentive timer (contact)	ST	○	—	Decimal	89H	05H
Retentive timer (coil)	ST	○	—	Decimal	8AH	05H
Retentive timer (current value)	ST	—	○	Decimal	8CH	05H
Counter (contact)	C	○	—	Decimal	11H	05H
Counter (coil)	C	○	—	Decimal	12H	05H
Counter (current value)	C	—	○	Decimal	14H	05H
Data register ^{*2}	D	—	○	Decimal	04H	05H
Link register ^{*2}	W	—	○	Hexadecimal	24H	05H
File register	R	—	○	Decimal	84H	05H
Link special relay	SB	○	—	Hexadecimal	63H	05H
Link special register	SW	—	○	Hexadecimal	64H	05H
Special relay	SM	○	—	Decimal	43H	05H
Special register	SD	—	○	Decimal	44H	05H

*1 Only the above devices can be specified. To write data to a bit device, specify it with 0 or a multiple of 16.

*2 D65536 and the subsequent extended data registers and of W10000 and the subsequent extended link registers cannot be specified.

Processing details

- This instruction writes data of the specified number of points from the buffer memory area of the target station or the device of its CPU module.
- From the master station, the instruction can be executed for the local, standby master, or intelligent device station. From the local or standby master station, the instruction can be executed for the master, local, or standby master station.
- The following figure shows how the G(P).RIWT instruction operates during execution.

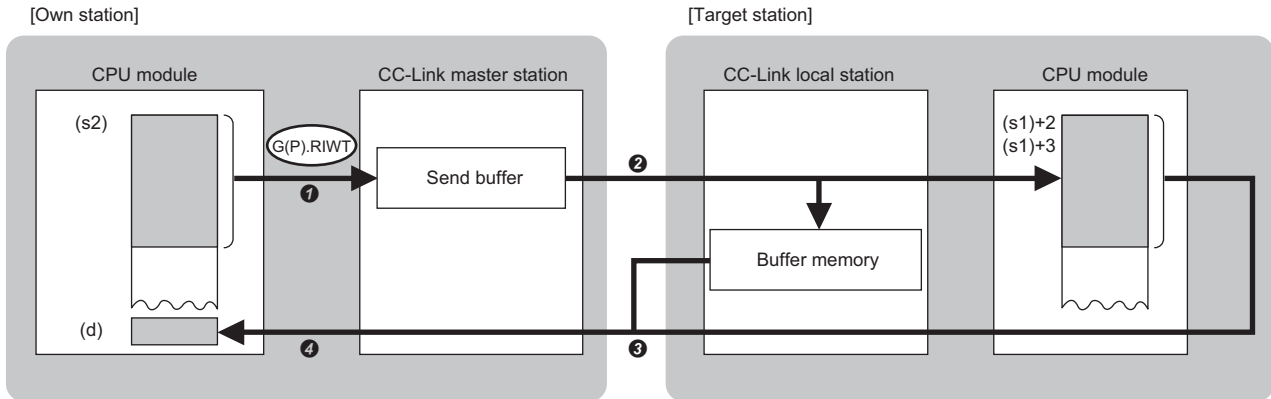

- 1 The data specified by (s2) is stored in the send buffer of the master station.
- 2 Data in the send buffer is written to the buffer memory area specified by (s1)+2 and (s1)+3 that is included in the station specified by (s1)+1 or to the device of the CPU module.
- 3 The response indicating the write completion returns from the target station to the master station.
- 4 The device specified by (d) is turned on.

- The completion status of the G(P).RIWT instruction can be checked with the completion device (d) and the completion status indication device (d)+1.

- Completion device (d)

This device turns on during END processing of the scan where the G(P).RIWT instruction completes, and turns off during the next END processing.

- Completion status indication device (d)+1

This device turns on or off depending on the completion status of the G(P).RIWT instruction.

When completed successfully: The device remains off.

When completed with an error: The device turns on during END processing of the scan where the G(P).RIWT instruction completes, and turns off during the next END processing.

Precautions

- The monitoring time and the number of retries can be set with the following link special registers (SWs).
 - Monitoring time setting (SW0009)
 - Setting of the number of retries for dedicated instruction (SW000B)
- The G(P).RIWT instruction can be concurrently executed from the master station for two or more local or intelligent device stations. Two or more dedicated instructions cannot be concurrently executed for a single station. Two or more dedicated instructions, including those other than G(P).RIWT, cannot be concurrently executed from a local station even for another station. If the next dedicated instruction is issued before completion of the preceding one that has started, the next one will be ignored. Create the program so that the next dedicated instruction will start after the completion device turns on, because processing of a dedicated instruction takes several scans until its completion.

Operation error

Error code ((s1)+0)	Description
4000H to 4FFFH	MELSEC iQ-R CPU Module User's Manual (Application)
B000H to BFFFH	MELSEC iQ-R CC-Link System Master/Local Module User's Manual (Application)

8.3 Reading Data from the Buffer Memory of the Specified Intelligent Device Station

G(P).RIRCV



These instructions automatically perform handshake with the specified intelligent device station and read data from its buffer memory area. The instructions can be used for communications with a module supporting a handshake signal such as AJ65BT-R2N.

Ladder	ST
	<pre>ENO:=G_RIRCV(EN,U,s1,s2,d1,d2); ENO:=GP_RIRCV(EN,U,s1,s2,d1,d2);</pre>

FBD/LD

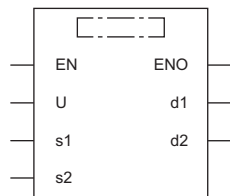

Execution condition

Instruction	Execution condition
G.RIRCV	
GP.RIRCV	

Setting data

Description, range, data type

Operand	Description	Range	Data type	Data type (label)
(U)	Start I/O number (first three digits in four-digit hexadecimal representation) of a module	00H to FEH	16-bit unsigned binary	ANY16
(s1)	Start device where control data is stored	Refer to the control data.	Device name	ANY16 ^{*1}
(d1)	Start device for storing the read data	—	Device name	ANY16 ^{*1}
(s2)	Start device for storing the interlock signal	—	Device name	ANY16 ^{*1}
(d2)	Device that turns on for one scan upon completion of the instruction When the instruction completes with an error, (d2)+1 also turns on.	—	Bit	ANYBIT_ARRAY (Number of elements: 2)
EN	Execution condition	—	Bit	BOOL
ENO	Execution result	—	Bit	BOOL

*1 When specifying setting data by using a label, define an array to secure enough operation area and specify an element of the array label.

■Applicable devices

Operand	Bit		Word			Double word		Indirect specification	Constant			Others (U)
	X, Y, M, L, SM, F, B, SB, FX, FY	J□□	T, ST, C, D, W, SD, SW, FD, R, ZR, RD	U□\G□, J□□, U3E□(H)G□	Z	LT, LST, LC	LZ		K, H	E	\$	
(U)*1	—	—	○	—	—	—	○	○	—	—	○	
(s1)	—	—	○*3	—	—	—	○	—	—	—	—	
(d1)	—	—	○*3	—	—	—	○	—	—	—	—	
(s2)	—	—	○*3	—	—	—	○	—	—	—	—	
(d2)	○*2	—	○*4	—	—	—	—	—	—	—	—	

*1 Index modification is not available.

*2 FX and FY cannot be used.

*3 FD cannot be used.

*4 T, ST, C, and FD cannot be used.

■Control data

Operand: (s1)				
Device	Item	Description	Setting range	Set by
+0	Completion status	The completion status is stored upon completion of the instruction. • 0: Completed successfully • Other than 0: Completed with an error (error code)	—	System
+1	Station number	Specify the station number of the target station.	1 to 64	User
+2	Access/attribute code	Specifies 0004H.	0004H	User
+3	Buffer memory address	Specifies the start address of the buffer memory area from which to read data.	Refer to the manual of the target station.	User
+4	Number of read points	Specifies, in units of words, the number of points to be read.	1 to 480*1	User

*1 Specify a value within the capacity of the target station buffer memory area.

■Interlock signal

Operand: (s2)																
Device	Item	Description	Setting range	Set by												
+0	<table border="1" style="width: 100%; border-collapse: collapse;"> <tr> <td style="text-align: center;">b15</td> <td style="text-align: center;">...</td> <td style="text-align: center;">b8</td> <td style="text-align: center;">b7</td> <td style="text-align: center;">...</td> <td style="text-align: center;">b0</td> </tr> <tr> <td style="text-align: center;">0</td> <td></td> <td></td> <td style="text-align: center;">RY</td> <td></td> <td></td> </tr> </table>	b15	...	b8	b7	...	b0	0			RY			RY: Specifies the number of the completion signal (RY) to be used for interlock.*1	00H to 7FH	User
b15	...	b8	b7	...	b0											
0			RY													
+1	<table border="1" style="width: 100%; border-collapse: collapse;"> <tr> <td style="text-align: center;">b15</td> <td style="text-align: center;">...</td> <td style="text-align: center;">b8</td> <td style="text-align: center;">b7</td> <td style="text-align: center;">...</td> <td style="text-align: center;">b0</td> </tr> <tr> <td style="text-align: center;">0</td> <td></td> <td></td> <td style="text-align: center;">RX</td> <td></td> <td></td> </tr> </table>	b15	...	b8	b7	...	b0	0			RX			RX: Specifies the number of the read request signal (RX) to be used for interlock.*1	00H to 7FH	User
b15	...	b8	b7	...	b0											
0			RX													
+2	Dummy	Specifies 0.	0	User												

*1 For the interlock signal, refer to the following.

📖 Manual of the intelligent device station from which to read data

Processing details

- This instruction automatically performs handshake with the specified intelligent device station and reads data from its buffer memory.
- The instruction can be executed, from the master station, for an intelligent device station with a handshake signal (e.g. AJ65BT-R2N).
- The following figure shows how the G(P).RIRCV instruction operates during execution.

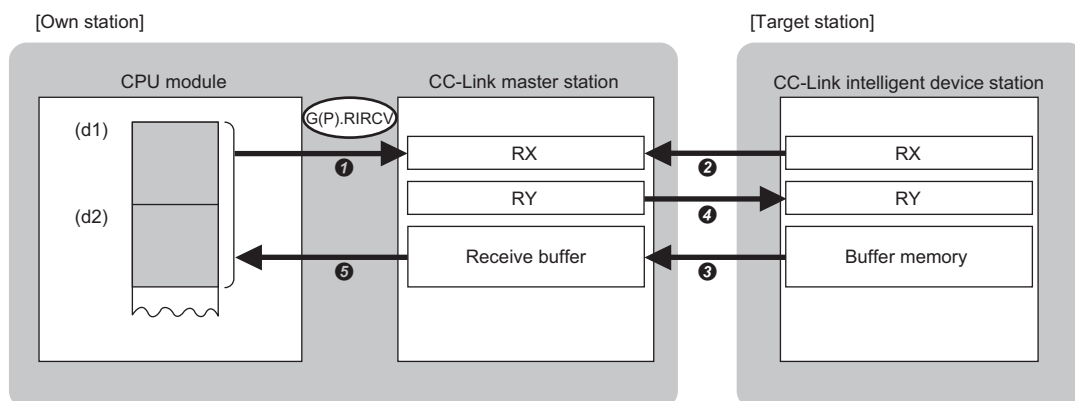

- ➊ A request is issued to read data from the buffer memory address specified by (s1)+3 that is included in the station specified by (s1)+1.
- ➋ The remote input (RX) specified by (s2)+1 that is in the station specified by (s1)+1 is monitored.
- ➌ The master station reads the data from the buffer memory of the target station by turning on the remote input (RX). The read data is stored in the receive buffer of the master station.
- ➍ The master station turns on the remote output (RY) specified by (s2)+0. Turning off the remote input (RX) specified by (s2)+1 turns off the remote output (RY) specified by (s2)+0.
- ➎ The data read from the target station is stored in the device specified by (d1) and later, and the device specified by (d2) is turned on.

- The completion status of the G(P).RIRCV instruction can be checked with the completion device (d2) and the completion status indication device (d2)+1.

- Completion device (d2)

This device turns on during END processing of the scan where the G(P).RIRCV instruction completes, and turns off during the next END processing.

- Completion status indication device (d2)+1

This device turns on or off depending on the completion status of the G(P).RIRCV instruction.

When completed successfully: The device remains off.

When completed with an error: The device turns on during END processing of the scan where the G(P).RIRCV instruction completes, and turns off during the next END processing.

Precautions

- The monitoring time and the number of retries can be set with the following link special registers (SWs).
 - Monitoring time setting (SW0009)
 - Setting of the number of retries for dedicated instruction (SW000B)
- The G(P).RIRCV instruction can be concurrently executed for two or more intelligent device stations. Two or more dedicated instructions, including those other than G(P).RIRD, cannot be concurrently executed for a single station. If the next dedicated instruction is issued before completion of the preceding one that has started, the next one will be ignored. Create the program so that the next dedicated instruction will start after the completion device turns on, because processing of a dedicated instruction takes several scans until its completion.

Operation error

Error code ((s1)+0)	Description
4000H to 4FFFH	📖 MELSEC iQ-R CPU Module User's Manual (Application)
B000H to BFFFH	📖 MELSEC iQ-R CC-Link System Master/Local Module User's Manual (Application)

8.4 Writing Data to the Buffer Memory of the Specified Intelligent Device Station

G(P).RISEND

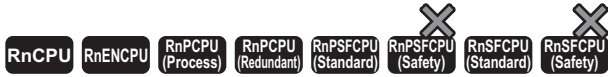

These instructions automatically perform a handshake with the specified intelligent device station and writes data to its buffer memory. The instructions can be used for communications with a module supporting a handshake signal such as AJ65BT-R2N.

Ladder	ST
	<pre>ENO:=G_RISEND(EN,U,s1,s2,s3,d); ENO:=GP_RISEND(EN,U,s1,s2,s3,d);</pre>

FBD/LD

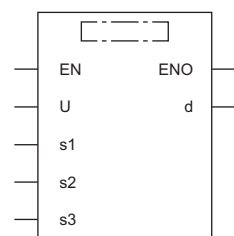

Execution condition

Instruction	Execution condition
G.RISEND	
GP.RISEND	

Setting data

Description, range, data type

Operand	Description	Range	Data type	Data type (label)
(U)	Start I/O number (first three digits in four-digit hexadecimal representation) of a module	00H to FEH	16-bit unsigned binary	ANY16
(s1)	Start device where control data is stored	Refer to the control data.	Device name	ANY16 ^{*1}
(s2)	Start device for storing the data to be written	—	Device name	ANY16 ^{*1}
(s3)	Start device for storing the interlock signal	—	Device name	ANY16 ^{*1}
(d)	Device that turns on for one scan upon completion of the instruction When the instruction completes with an error, (d)+1 also turns on.	—	Bit	ANYBIT_ARRAY (Number of elements: 2)
EN	Execution condition	—	Bit	BOOL
ENO	Execution result	—	Bit	BOOL

*1 When specifying setting data by using a label, define an array to secure enough operation area and specify an element of the array label.

■Applicable devices

Operand	Bit		Word			Double word		Indirect specification	Constant			Others (U)
	X, Y, M, L, SM, F, B, SB, FX, FY	J□□	T, ST, C, D, W, SD, SW, FD, R, ZR, RD	U□V□, J□□□, U3E□(H)G□	Z	LT, LST, LC	LZ		K, H	E	\$	
(U)*1	—	—	○	—	—	—	○	○	—	—	○	
(s1)	—	—	○*3	—	—	—	○	—	—	—	—	
(s2)	—	—	○*3	—	—	—	○	—	—	—	—	
(s3)	—	—	○*3	—	—	—	○	—	—	—	—	
(d)	○*2	—	○*4	—	—	—	—	—	—	—	—	

*1 Index modification is not available.

*2 FX and FY cannot be used.

*3 FD cannot be used.

*4 T, ST, C, and FD cannot be used.

■Control data

Operand: (s1)				
Device	Item	Description	Setting range	Set by
+0	Completion status	The completion status is stored upon completion of the instruction. • 0: Completed successfully • Other than 0: Completed with an error (error code)	—	System
+1	Station number	Specify the station number of the target station.	1 to 64	User
+2	Access/attribute code	Specifies 0004H.	0004H	User
+3	Buffer memory address	Specifies the start address of the buffer memory area where to write data.	Refer to the manual of the target station.	User
+4	Number of write points	Specifies, in units of words, the number of points to be written.	1 to 480*1	User

*1 Specify a value within the capacity of the target station buffer memory area.

■Interlock signal

Operand: (s3)																
Device	Item	Description	Setting range	Set by												
+0	<table border="1" style="width: 100%; border-collapse: collapse;"> <tr> <td style="text-align: center;">b15</td> <td style="text-align: center;">...</td> <td style="text-align: center;">b8</td> <td style="text-align: center;">b7</td> <td style="text-align: center;">...</td> <td style="text-align: center;">b0</td> </tr> <tr> <td style="text-align: center;">0</td> <td></td> <td></td> <td style="text-align: center;">RY</td> <td></td> <td></td> </tr> </table>	b15	...	b8	b7	...	b0	0			RY			RY: Specifies the number of the write request signal (RY) to be used for interlock.*1	00H to 7FH	User
b15	...	b8	b7	...	b0											
0			RY													
+1	<table border="1" style="width: 100%; border-collapse: collapse;"> <tr> <td style="text-align: center;">b15</td> <td style="text-align: center;">...</td> <td style="text-align: center;">b8</td> <td style="text-align: center;">b7</td> <td style="text-align: center;">...</td> <td style="text-align: center;">b0</td> </tr> <tr> <td style="text-align: center;">RWr*1</td> <td></td> <td></td> <td style="text-align: center;">RX</td> <td></td> <td></td> </tr> </table>	b15	...	b8	b7	...	b0	RWr*1			RX			RX: Specifies the number of the write completion signal (RX) to be used for interlock.*1 RWr: Specifies the number of the device in which to store the error code (RWr). If the error code storage device does not exist, specify FFH.	00H to 7FH 00H to 0FH, FFH*2	User User
b15	...	b8	b7	...	b0											
RWr*1			RX													
+2	Completion mode	Specifies how the completion signal behaves. • 0: Using Device 1 During completion, the RX signal specified by (s2)+1 turns on. • 1: Using Device 2 For normal completion, the RX signal specified by (s2)+1 turns on. For error completion, both RX and RX+1 turn on simultaneously.	0, 1	User												

*1 For the interlock signal, refer to the following.

Manual of the intelligent device station from which to read data

*2 The error code stored in the error code storage device is the same as the completion status of control data ((s1)+0).

Processing details

- This instruction automatically performs handshake with the specified intelligent device station and writes data to its buffer memory.
- The instruction can be executed, from the master station, for an intelligent device station with a handshake signal (e.g. AJ65BT-R2N).
- The following figure shows how the G(P).RISEND instruction operates during execution.

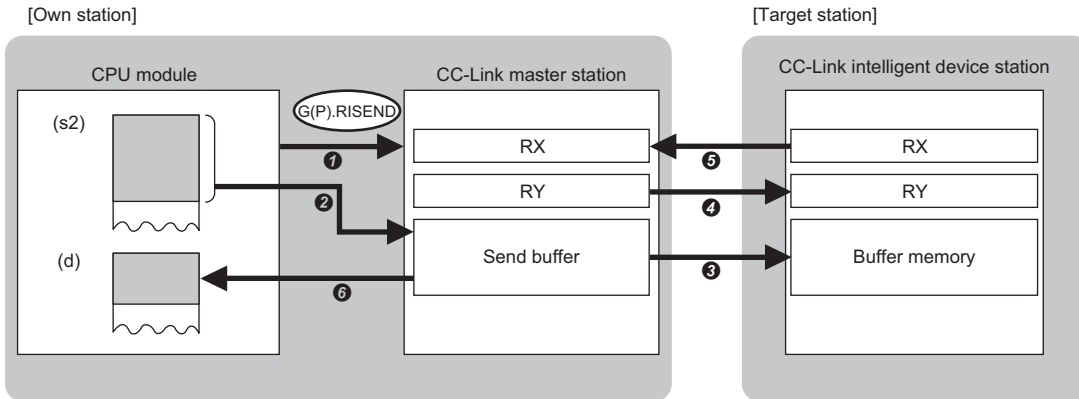

- ➊ A request is issued to write data to the buffer memory address specified by (s1)+3 that is included in the station specified by (s1)+1.
- ➋ The data of the device specified by (s2) and later is stored in the send buffer of the master station.
- ➌ The master station writes the data of the send buffer in the buffer memory of the target station.
- ➍ The master station turns on the remote output (RY) specified by (s3)+0.
- ➎ Upon completion of processing of the remote output (RY), the target station turns on the remote input (RX) specified by (s3)+1. Turning off the remote output (RY) specified by (s3)+0 turns off the remote input (RX) specified by (s3)+1.
- ➏ The device specified by (d) is turned on.

- The completion status of the G(P).RISEND instruction can be checked with the completion device (d) and the completion status indication device (d)+1.

- Completion device (d)

This device turns on during END processing of the scan where the G(P).RISEND instruction completes, and turns off during the next END processing.

- Completion status indication device (d)+1

This device turns on or off depending on the completion status of the G(P).RISEND instruction.

When completed successfully: The device remains off.

When completed with an error: The device turns on during END processing of the scan where the G(P).RISEND instruction completes, and turns off during the next END processing.

Precautions

- The monitoring time and the number of retries can be set with the following link special registers (SWs).
 - Monitoring time setting (SW0009)
 - Setting of the number of retries for dedicated instruction (SW000B)
- The G(P).RISEND instruction can be concurrently executed for two or more intelligent device stations. Two or more dedicated instructions, including those other than G(P).RIRD, cannot be concurrently executed for a single station. If the next dedicated instruction is issued before completion of the preceding one that has started, the next one will be ignored. Create the program so that the next dedicated instruction will start after the completion device turns on, because processing of a dedicated instruction takes several scans until its completion.

Operation error

Error code ((s1)+0)	Description
4000H to 4FFFH	📖 MELSEC iQ-R CPU Module User's Manual (Application)
B000H to BFFFH	📖 MELSEC iQ-R CC-Link System Master/Local Module User's Manual (Application)

8.5 Reading Data from the Automatic Update Buffer

G(P).RIFR

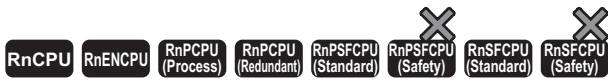

These instructions read data from the automatic update buffer or random access buffer. The instructions can be used for communications with a module having the automatic update buffer such as AJ65BT-R2N.

Ladder	ST
	<pre>ENO:=G_RIFR(EN,U,s1,s2,n,d); ENO:=G_RIFR(EN,U,s1,s2,n,d);</pre>

FBD/LD

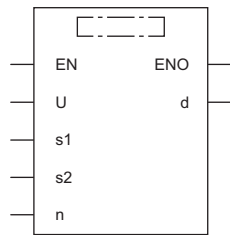

Execution condition

Instruction	Execution condition
G.RIFR	
GP.RIFR	

Setting data

Description, range, data type

Operand	Description	Range	Data type	Data type (label)
(U)	Start I/O number (first three digits in four-digit hexadecimal representation) of a module	00H to FEH	16-bit unsigned binary	ANY16
(s1)	If data is read from an automatic update buffer: Station number of intelligent device station	1 to 64	16-bit unsigned binary	ANY16
	If data is read from a random access buffer: Specifies the random access buffer.	00FFH	16-bit unsigned binary	ANY16
(s2)	Offset value from the start of the automatic update or random access buffer that has been assigned to the target station	0 to parameter set value ^{*1}	16-bit unsigned binary	ANY16
(d)	Start device for storing the read data	—	Device name	ANY16 ^{*2}
(n)	Number of read points	1 to 4096	16-bit unsigned binary	ANY16
EN	Execution condition	—	Bit	BOOL
ENO	Execution result	—	Bit	BOOL

*1 Value that was set in the CC-Link configuration window of the engineering tool.

*2 When specifying setting data by using a label, define an array to secure enough operation area and specify an element of the array label.

■Applicable devices

Operand	Bit		Word			Double word		Indirect specification	Constant			Others (U)
	X, Y, M, L, SM, F, B, SB, FX, FY	J□\□	T, ST, C, D, W, SD, SW, FD, R, ZR, RD	U□\G□, J□\□, U3E□(H)G□	Z	LT, LST, LC	LZ		K, H	E	\$	
(U)*1	—	—	○	—	—	—	○	○	—	—	○	
(s1)	○*2	—	○*3	—	—	—	○	○	—	—	—	
(s2)	○*2	—	○*3	—	—	—	○	○	—	—	—	
(d)	—	—	○*3	—	—	—	○	—	—	—	—	
(n)	○*2	—	○*3	—	—	—	○	○	—	—	—	

*1 Index modification is not available.

*2 FX and FY cannot be used.

*3 FD cannot be used.

Processing details

- Data is read from the automatic update or random access buffer of the master station.
- The instruction can be executed, from the master station, for an intelligent device station that performs communication with an automatic update buffer (e.g. AJ65BT-R2N).
- The following figure shows how the G(P).RIFR instruction operates during execution.

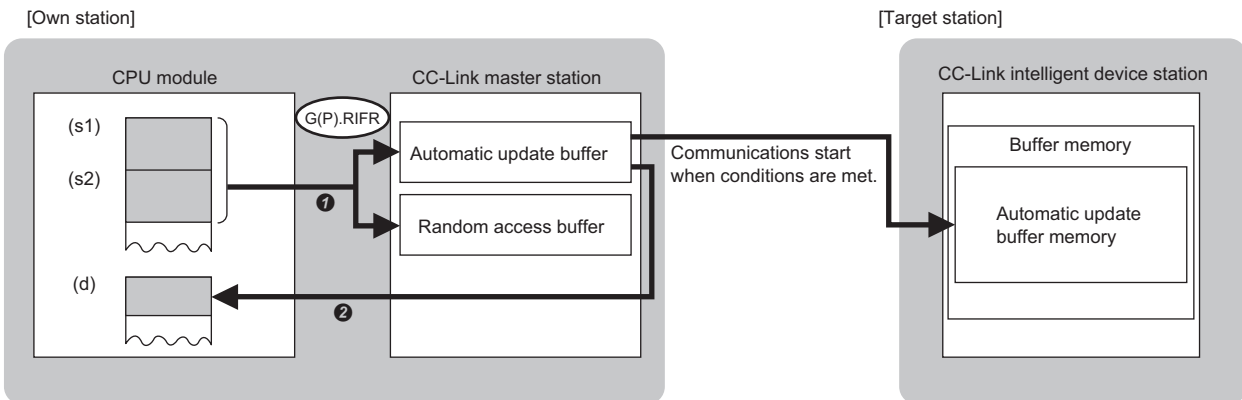

① Data is read from the automatic update or random access buffer specified by (s1) and (s2) that is in the master station.

② The read data is stored in the device specified by (d) and later.

Precautions

- Assignment of the automatic update buffer can be achieved by CC-Link configuration setting of the module parameters.

Operation error

Error code (SD0)	Description
4000H to 4FFFH	📖 MELSEC iQ-R CPU Module User's Manual (Application)

8.6 Writing Data to the Automatic Update Buffer

G(P).RITO



These instructions write data to the automatic update buffer or random access buffer. The instructions can be used for communications with a module having the automatic update buffer such as AJ65BT-R2N.

Ladder	ST
	<pre>ENO:=G_RITO(EN,U,s,n,d1,d2); ENO:=GP_RITO(EN,U,s,n,d1,d2);</pre>

FBD/LD

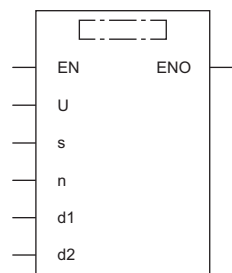

Execution condition

Instruction	Execution condition
G.RITO	
GP.RITO	

Setting data

Description, range, data type

Operand	Description	Range	Data type	Data type (label)
(U)	Start I/O number (first three digits in four-digit hexadecimal representation) of a module	00H to FEH	16-bit unsigned binary	ANY16
(d1)	If data is written to an automatic update buffer: Station number of target station	1 to 64	16-bit unsigned binary	ANY16
	If data is written to a random access buffer: Specifies the random access buffer.	00FFH	16-bit unsigned binary	ANY16
(d2)	Offset value from the start of the automatic update or random access buffer that has been assigned to the target station	0 to parameter set value ^{*1}	16-bit unsigned binary	ANY16
(s)	Start device for storing the data to be written	—	Device name	ANY16 ^{*2}
(n)	Number of write points	1 to 4096	16-bit unsigned binary	ANY16
EN	Execution condition	—	Bit	BOOL
ENO	Execution result	—	Bit	BOOL

*1 Value that was set in the CC-Link configuration window of the engineering tool.

*2 When specifying setting data by using a label, define an array to secure enough operation area and specify an element of the array label.

■Applicable devices

Operand	Bit		Word				Double word		Indirect specification	Constant			Others (U)
	X, Y, M, L, SM, F, B, SB, FX, FY	J□□	T, ST, C, D, W, SD, SW, FD, R, ZR, RD	U□\G□, J□□, U3E□(H)G□	Z	LT, LST, LC	LZ	K, H		E	\$		
(U)*1	—	—	○	—	—	—	—	○	○	—	—	○	
(d1)	○*2	—	○*3	—	—	—	—	○	○	—	—	—	
(d2)	○*2	—	○*3	—	—	—	—	○	○	—	—	—	
(s)	—	—	○*3	—	—	—	—	○	—	—	—	—	
(n)	○*2	—	○*3	—	—	—	—	○	○	—	—	—	

*1 Index modification is not available.

*2 FX and FY cannot be used.

*3 FD cannot be used.

Processing details

- Data is written to the automatic update or random access buffer of the master station.
- The instruction can be executed, from the master station, for an intelligent device station that performs communication with an automatic update buffer (e.g. AJ65BT-R2N).
- The following figure shows how the G(P).RITO instruction operates during execution.

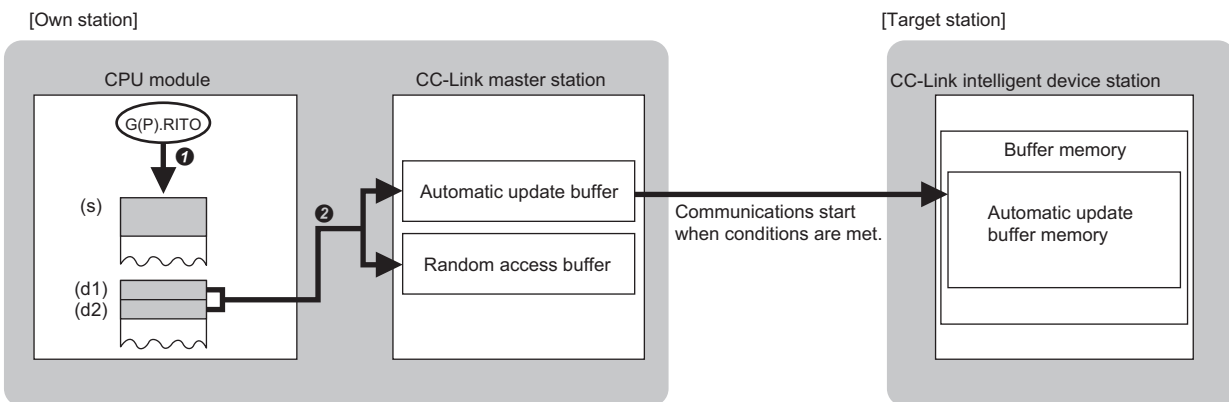

① Data is read from the device specified by (s) and later of the master station.

② The read data is written to the automatic update or random access buffer specified by (d1) and (d2).

Precautions

- Assignment of the automatic update buffer can be achieved by CC-Link configuration setting of the module parameters.

Operation error

Error code (SD0)	Description
4000H to 4FFFH	📖 MELSEC iQ-R CPU Module User's Manual (Application)

8.7 Setting Network Parameters

G(P).RLPASET

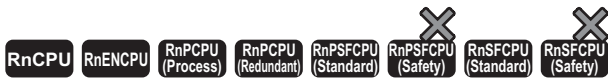

These instructions set the network parameters in the master station and starts up the data link.

Ladder	ST
	<pre>ENO:=G_RLPASET(EN,U,s1,s2,s3,s4,s5,d); ENO:=GP_RLPASET(EN,U,s1,s2,s3,s4,s5,d);</pre>

FBD/LD

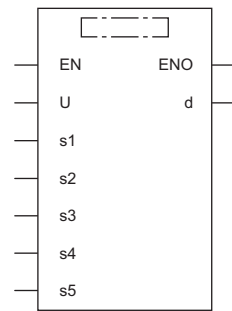

Execution condition

Instruction	Execution condition
G.RLPASET	
GP.RLPASET	

Setting data

Description, range, data type

Operand	Description	Range	Data type	Data type (label)
(U)	Start I/O number (first three digits in four-digit hexadecimal representation) of a module	00H to FEH	16-bit unsigned binary	ANY16
(s1)	Start device where control data is stored	Refer to the control data.	Device name	ANY16 ^{*1}
(s2) ^{*2}	Start device where the slave station setting data is stored	—	Device name	ANY16 ^{*1}
(s3) ^{*2}	Start device where the reserved station specification data is stored	—	Device name	ANY16 ^{*1}
(s4) ^{*2}	Start device where the error invalid station specification data is stored	—	Device name	ANY16 ^{*1}
(s5) ^{*2}	Start device where the automatic update buffer assignment data is stored	—	Device name	ANY16 ^{*1}
(d)	Device that turns on for one scan upon completion of the instruction When the instruction completes with an error, (d)+1 also turns on.	—	Bit	ANYBIT_ARRAY (Number of elements: 2)
EN	Execution condition	—	Bit	BOOL
ENO	Execution result	—	Bit	BOOL

*1 When specifying setting data by using a label, define an array to secure enough operation area and specify an element of the array label.

*2 If this operand is omitted, specify the dummy device or label.

■Applicable devices

Operand	Bit		Word			Double word		Indirect specification	Constant			Others (U)
	X, Y, M, L, SM, F, B, SB, FX, FY	J□□	T, ST, C, D, W, SD, SW, FD, R, ZR, RD	U□V□, J□□, U3E□(H)G□	Z	LT, LST, LC	LZ		K, H, E, \$			
(U)*1	—	—	○	—	—	—	○	○	—	—	○	
(s1)	—	—	○*3	—	—	—	○	—	—	—	—	
(s2)	—	—	○*3	—	—	—	○	—	—	—	—	
(s3)	—	—	○*3	—	—	—	○	—	—	—	—	
(s4)	—	—	○*3	—	—	—	○	—	—	—	—	
(s5)	—	—	○*3	—	—	—	○	—	—	—	—	
(d)	○*2	—	○*4	—	—	—	—	—	—	—	—	

*1 Index modification is not available.

*2 FX and FY cannot be used.

*3 FD cannot be used.

*4 T, ST, C, and FD cannot be used.

■Control data

Operand: (s1)																										
Device	Item	Description	Setting range	Set by																						
+0	Completion status	The completion status is stored upon completion of the instruction. • 0: Completed successfully • Other than 0: Completed with an error (error code)	—	System																						
+1	Setting flag	Specifies whether the setting data in (s2) to (s5) are valid/invalid. • 0: Invalid*1 • 1: Valid <table border="1" style="margin-left: 20px;"> <tr> <td>b15</td><td>b14</td><td>b13</td><td>b12</td><td>b11</td><td>...</td><td>b4</td><td>b3</td><td>b2</td><td>b1</td><td>b0</td> </tr> <tr> <td>0</td><td>0</td><td>(6)</td><td>(5)</td><td>0</td><td></td><td>0</td><td>(4)</td><td>(3)</td><td>(2)</td><td>(1)</td> </tr> </table> (1) Slave station setting data (s2) (2) Reserved station specification data (s3) (3) Error invalid station specification data (s4) (4) Automatic update buffer assignment data (s5) (5) Data link faulty station setting • 0: Data in the remote input (RX) are cleared. • 1: Data in the remote input (RX) are held. (6) Output setting for CPU STOP • 0: Data are refreshed to the remote output (RY). • 1: Data, 0, is sent to the remote output (RY).	b15	b14	b13	b12	b11	...	b4	b3	b2	b1	b0	0	0	(6)	(5)	0		0	(4)	(3)	(2)	(1)	—	User
b15	b14	b13	b12	b11	...	b4	b3	b2	b1	b0																
0	0	(6)	(5)	0		0	(4)	(3)	(2)	(1)																
+2	Total number of connected modules/stations	Specifies the number of slave stations to be connected.	1 to 64	User																						
+3	Number of retries	Specifies the number of retries to be performed for a communication error station.	1 to 7	User																						
+4	Number of automatic return modules	Specifies the number of slave stations that can return by one link scan.	1 to 10	User																						
+5	Data link setting when CPU is down	Specifies whether to stop or continue the data link when the CPU module causes a stop error. • 0: Stops the data link. • 1: Continues the data link.	0, 1	User																						
+6	Scan mode setting	Specifies whether the link scan be unsynchronized or synchronized with the sequence scan. If it is unsynchronized, the output transmission delay time will shorten. • 0: Unsynchronized with sequence scan • 1: Synchronized with sequence scan	0, 1	User																						

*1 The default value will be used for any setting data specified as invalid. For the default values, refer to the following.

☞ Page 360 Slave station setting data

☞ Page 360 Reserved station specification data

☞ Page 361 Error invalid station specification data

☞ Page 361 Automatic update buffer assignment data

Slave station setting data

Operand: (s2)										
Device	Item	Description	Setting range	Set by						
+0 to +63	Station information settings ^{*1}	<p>Specifies the station number, the number of occupied stations, and the station type for each slave station.</p> <table border="1" style="margin-left: 20px;"> <tr> <td style="text-align: center;">b15 ... b12</td> <td style="text-align: center;">b11 ... b8</td> <td style="text-align: center;">b7 ... b0</td> </tr> <tr> <td style="text-align: center;">(3)</td> <td style="text-align: center;">(2)</td> <td style="text-align: center;">(1)</td> </tr> </table> <p>The default value range is 0101H to 0140H, meaning that the station number is 1 to 64, the number of occupied stations is 1 station occupied, and the station type is remote I/O station for Ver. 1.</p>	b15 ... b12	b11 ... b8	b7 ... b0	(3)	(2)	(1)	—	User
b15 ... b12	b11 ... b8	b7 ... b0								
(3)	(2)	(1)								
		(1) Station number setting 1 to 64	01H to 40H	User						
		(2) Number of occupied stations setting <ul style="list-style-type: none"> • 1H: 1 station occupied • 2H: 2 stations occupied • 3H: 3 stations occupied • 4H: 4 stations occupied 	1H to 4H	User						
		(3) Station type setting ^{*2} <ul style="list-style-type: none"> • 0H: Remote I/O station for Ver. 1 • 1H: Remote device station for Ver. 1 • 2H: Intelligent device station for Ver. 1 • 5H: Single remote device station for Ver. 2 • 6H: Single intelligent device station for Ver. 2 • 8H: Double remote device station for Ver. 2 • 9H: Double intelligent device station for Ver. 2 • BH: Quadruple remote device station for Ver. 2 • CH: Quadruple intelligent device station for Ver. 2 • EH: Octuple remote device station for Ver. 2 • FH: Quadruple intelligent device station for Ver. 2 	0H to FH	User						

*1 Set parameters for the total number of connected modules/stations specified by (s1)+2.

*2 If a local station is specified, specify the intelligent device station.

Reserved station specification data

Operand: (s3)																																																						
Device	Item	Description	Setting range	Set by																																																		
+0 to +3	Reserved station specification	<p>Specifies a reserved station in a station-by-station manner.^{*1}</p> <ul style="list-style-type: none"> • 0: Not specified • 1: Specified <table border="1" style="margin-left: 20px;"> <tr> <td></td> <td style="text-align: center;">b15</td> <td style="text-align: center;">b14</td> <td style="text-align: center;">b13</td> <td style="text-align: center;">b12</td> <td style="text-align: center;">...</td> <td style="text-align: center;">b3</td> <td style="text-align: center;">b2</td> <td style="text-align: center;">b1</td> <td style="text-align: center;">b0</td> </tr> <tr> <td>(s3)+0</td> <td style="text-align: center;">16</td> <td style="text-align: center;">15</td> <td style="text-align: center;">14</td> <td style="text-align: center;">13</td> <td style="text-align: center;">...</td> <td style="text-align: center;">4</td> <td style="text-align: center;">3</td> <td style="text-align: center;">2</td> <td style="text-align: center;">1</td> </tr> <tr> <td>(s3)+1</td> <td style="text-align: center;">32</td> <td style="text-align: center;">31</td> <td style="text-align: center;">30</td> <td style="text-align: center;">29</td> <td style="text-align: center;">...</td> <td style="text-align: center;">20</td> <td style="text-align: center;">19</td> <td style="text-align: center;">18</td> <td style="text-align: center;">17</td> </tr> <tr> <td>(s3)+2</td> <td style="text-align: center;">48</td> <td style="text-align: center;">47</td> <td style="text-align: center;">46</td> <td style="text-align: center;">45</td> <td style="text-align: center;">...</td> <td style="text-align: center;">36</td> <td style="text-align: center;">35</td> <td style="text-align: center;">34</td> <td style="text-align: center;">33</td> </tr> <tr> <td>(s3)+3</td> <td style="text-align: center;">64</td> <td style="text-align: center;">63</td> <td style="text-align: center;">62</td> <td style="text-align: center;">61</td> <td style="text-align: center;">...</td> <td style="text-align: center;">52</td> <td style="text-align: center;">51</td> <td style="text-align: center;">50</td> <td style="text-align: center;">49</td> </tr> </table> <p>The default value is "0: Not specified" for all stations.</p>		b15	b14	b13	b12	...	b3	b2	b1	b0	(s3)+0	16	15	14	13	...	4	3	2	1	(s3)+1	32	31	30	29	...	20	19	18	17	(s3)+2	48	47	46	45	...	36	35	34	33	(s3)+3	64	63	62	61	...	52	51	50	49	—	User
	b15	b14	b13	b12	...	b3	b2	b1	b0																																													
(s3)+0	16	15	14	13	...	4	3	2	1																																													
(s3)+1	32	31	30	29	...	20	19	18	17																																													
(s3)+2	48	47	46	45	...	36	35	34	33																																													
(s3)+3	64	63	62	61	...	52	51	50	49																																													

*1 For two or more stations occupied, specify only the slave station start number.

■Error invalid station specification data

Operand: (s4)																																																						
Device	Item	Description	Setting range	Set by																																																		
+0 to +3	Error invalid station specification	<p>Specifies an error invalid station in a station-by-station manner.*1*2</p> <ul style="list-style-type: none"> • 0: Not specified • 1: Specified <table border="1"> <thead> <tr> <th></th> <th>b15</th> <th>b14</th> <th>b13</th> <th>b12</th> <th>...</th> <th>b3</th> <th>b2</th> <th>b1</th> <th>b0</th> </tr> </thead> <tbody> <tr> <td>(s4)+0</td> <td>16</td> <td>15</td> <td>14</td> <td>13</td> <td>...</td> <td>4</td> <td>3</td> <td>2</td> <td>1</td> </tr> <tr> <td>(s4)+1</td> <td>32</td> <td>31</td> <td>30</td> <td>29</td> <td>...</td> <td>20</td> <td>19</td> <td>18</td> <td>17</td> </tr> <tr> <td>(s4)+2</td> <td>48</td> <td>47</td> <td>46</td> <td>45</td> <td>...</td> <td>36</td> <td>35</td> <td>34</td> <td>33</td> </tr> <tr> <td>(s4)+3</td> <td>64</td> <td>63</td> <td>62</td> <td>61</td> <td>...</td> <td>52</td> <td>51</td> <td>50</td> <td>49</td> </tr> </tbody> </table> <p>The default value is "0: Not specified" for all stations.</p>		b15	b14	b13	b12	...	b3	b2	b1	b0	(s4)+0	16	15	14	13	...	4	3	2	1	(s4)+1	32	31	30	29	...	20	19	18	17	(s4)+2	48	47	46	45	...	36	35	34	33	(s4)+3	64	63	62	61	...	52	51	50	49	—	User
	b15	b14	b13	b12	...	b3	b2	b1	b0																																													
(s4)+0	16	15	14	13	...	4	3	2	1																																													
(s4)+1	32	31	30	29	...	20	19	18	17																																													
(s4)+2	48	47	46	45	...	36	35	34	33																																													
(s4)+3	64	63	62	61	...	52	51	50	49																																													

*1 For two or more stations occupied, specify only the slave station start number.

*2 If both the reserved and error invalid stations are specified for the same station, the reserved station specification will take priority.

■Automatic update buffer assignment data

Operand: (s5)																												
Device	Item	Description	Setting range	Set by																								
+0 to +77	Automatic update buffer assignment specification	<p>Specifies the assigned buffer memory size (words) that is used for the transient transmission with the automatic update buffer that is performed to the local or intelligent device station.*1</p> <ul style="list-style-type: none"> • 0: Not specified • 1: Specified <table border="1"> <tbody> <tr> <td>(s5)+0</td> <td colspan="2">Dummy</td> <td rowspan="3">} For the 1st module</td> </tr> <tr> <td>(s5)+1</td> <td colspan="2">Dummy</td> </tr> <tr> <td>(s5)+2</td> <td colspan="2">Automatic update buffer size</td> </tr> <tr> <td></td> <td colspan="2">⋮</td> <td></td> </tr> <tr> <td>(s5)+75</td> <td colspan="2">Dummy</td> <td rowspan="3">} For the 26th module</td> </tr> <tr> <td>(s5)+76</td> <td colspan="2">Dummy</td> </tr> <tr> <td>(s5)+77</td> <td colspan="2">Automatic update buffer size</td> </tr> </tbody> </table> <p>The default value is 0080H.</p>	(s5)+0	Dummy		} For the 1st module	(s5)+1	Dummy		(s5)+2	Automatic update buffer size			⋮			(s5)+75	Dummy		} For the 26th module	(s5)+76	Dummy		(s5)+77	Automatic update buffer size		0H (no setting) 0080H to 1000H*2	User
(s5)+0	Dummy		} For the 1st module																									
(s5)+1	Dummy																											
(s5)+2	Automatic update buffer size																											
	⋮																											
(s5)+75	Dummy		} For the 26th module																									
(s5)+76	Dummy																											
(s5)+77	Automatic update buffer size																											

*1 Beginning at the smallest station number, set the size for the slave stations for which the local or intelligent device station has been set with the slave station setting data ((s2)+0 to (s2)+63).

*2 The automatic update buffer size must be 1000H (4096) words or less in total. For the automatic update buffer size, specify the required size for each intelligent device station.

Processing details

- This instruction sets the network parameters in the master station and starts up the data link.
- This instruction can be executed only for the master station.
- The following figure shows how the G(P).RLPASET instruction operates during execution.

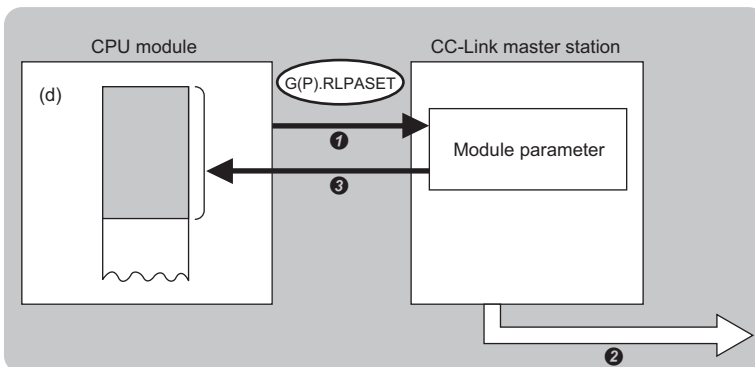

- ❶ The network parameters specified by (s1) to (s5) are written to the master station.
- ❷ The data link is started up.
- ❸ The device specified by (d) is turned on.

- The completion status of the G(P).RLPASET instruction can be checked with the completion device (d) and the completion status indication device (d)+1.

- Completion device (d)

This device turns on during END processing of the scan where the G(P).RLPASET instruction completes, and turns off during the next END processing.

- Completion status indication device (d)+1

This device turns on or off depending on the completion status of the G(P).RLPASET instruction.

When completed successfully: The device remains off.

When completed with an error: The device turns on during END processing of the scan where the G(P).RLPASET instruction completes, and turns off during the next END processing.

- After completion of the G(P).RLPASET instruction, turn on SB0003, a refresh instruction that is used for parameter change with the dedicated instruction, to start the cyclic data refresh.
- If no stations are faulty

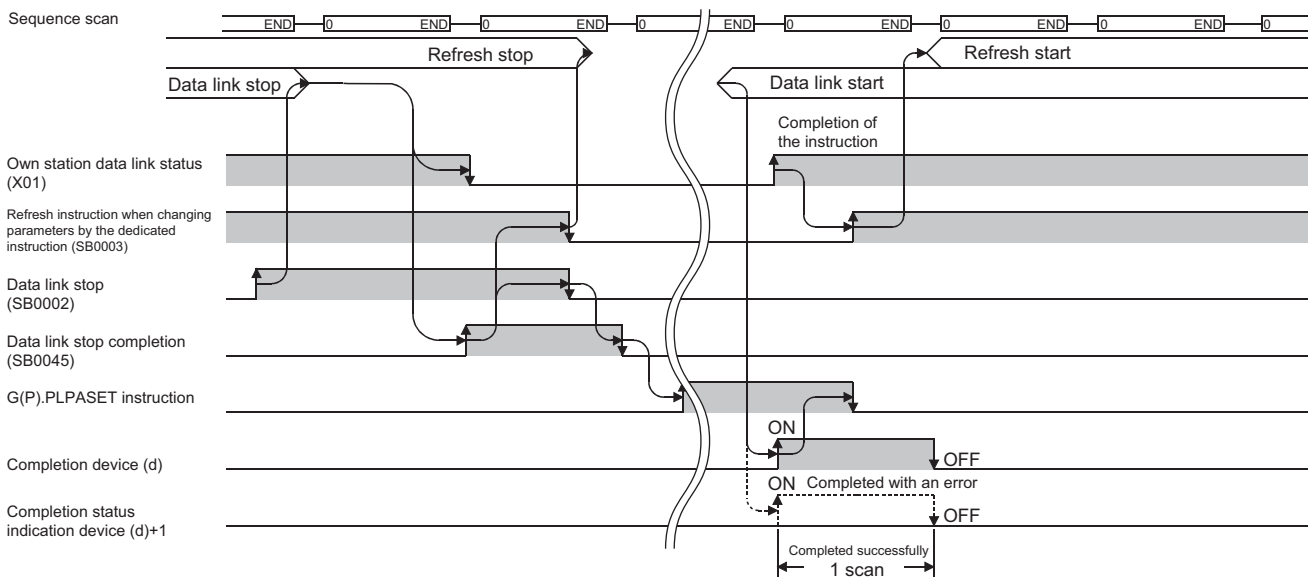

- If all stations are faulty

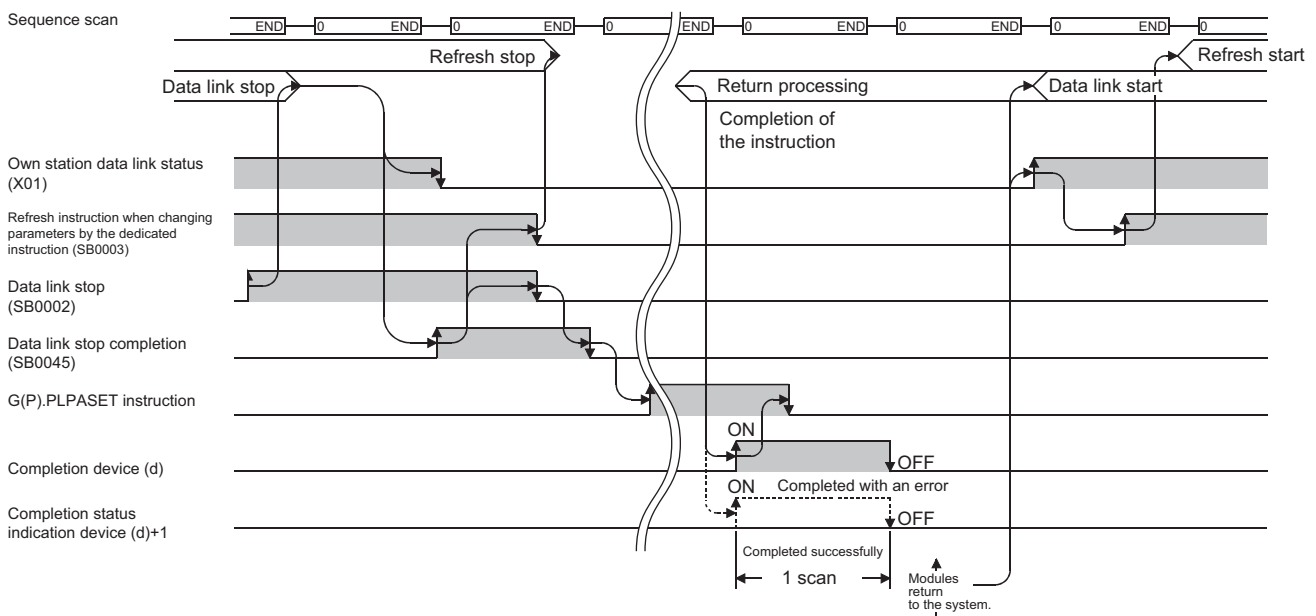

Precautions

- Two or more G(P).RLPASET instructions cannot be executed concurrently.
- The G(P).RLPASET instruction is not available in a system containing a standby master station.
- Do not set network parameters using the engineering tool for modules for which network parameters are set using the G(P).RLPASET instruction. If the G(P).RLPASET instruction is executed for a module for which network parameters are set using the engineering tool, the instruction will be terminated with an error and the network parameter settings are not reflected.
- Stop the data link using "Data Link Stop" (SB0002) before executing the G(P).RLPASET instruction.

Operation error

Error code ((s1)+0)	Description
B000H to BFFFH	MELSEC IQ-R CC-Link System Master/Local Module User's Manual (Application)

8.8 Performing a Message Transmission to a Remote Device Station

G(P).RDMSG



These instructions read/write parameters from/to the remote device station and read the status of the remote device station. The instructions can be executed to a remote device station, for example NZ2AW1C2AL, that supports the message transmission function.

Ladder	ST
	<pre>ENO:=G_RDMSG(EN,U,s1,s2,d1,d2); ENO:=GP_RDMSG(EN,U,s1,s2,d1,d2);</pre>

FBD/LD

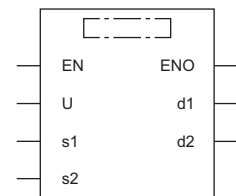

Execution condition

Instruction	Execution condition
G.RDMSG	
GP.RDMSG	

Setting data

Description, range, data type

Operand	Description	Range	Data type	Data type (label)
(U)	Start I/O number (first three digits in four-digit hexadecimal representation) of a module	00H to FEH	16-bit unsigned binary	ANY16
(s1)	Start device where control data is stored	Refer to the control data.	Device name	ANY16 ^{*2}
(s2) ^{*1}	Start device for storing the message data to be sent	—	Device name	ANY16 ^{*2}
(d1) ^{*1}	Start device for storing the message data received	—	Device name	ANY16
(d2)	Device that turns on for one scan upon completion of the instruction When the instruction completes with an error, (d2)+1 also turns on.	—	Bit	ANYBIT_ARRAY (Number of elements: 2)
EN	Execution condition	—	Bit	BOOL
ENO	Execution result	—	Bit	BOOL

*1 For details on the send data and receive data, refer to the following.

Manuals for the remote device stations that support the message transmission function

*2 When specifying setting data by using a label, define an array to secure enough operation area and specify an element of the array label.

■Applicable devices

Operand	Bit		Word			Double word		Indirect specification	Constant			Others (U)
	X, Y, M, L, SM, F, B, SB, FX, FY	J□\□	T, ST, C, D, W, SD, SW, FD, R, ZR, RD	U□\G□, J□\□, U3E□(H)G□	Z	LT, LST, LC	LZ		K, H	E	\$	
(U)*1	—	—	○	—	—	—	○	○	—	—	○	
(s1)	—	—	○	—	—	—	○	—	—	—	—	
(s2)	—	—	○	—	—	—	○	—	—	—	—	
(d1)	—	—	○	—	—	—	○	—	—	—	—	
(d2)	○	—	○	—	—	—	○	—	—	—	—	

*1 Index modification is not available.

■Control data

Operand: (s1)				
Device	Item	Description	Setting range	Set by
+0	Completion status	The completion status is stored upon completion of the instruction. • 0: Completed successfully • Other than 0: Completed with an error (error code)	—	System
+1	Station number	Specify the station number of the target station.	1 to 64	User
+2	Send data size	Specify the send message data size in bytes.	1 to 255	User
+3	Receivable data size	Specify the maximum size of the device that stores the receive message data in bytes.	0 to 255	User
+4	Receive data size	The receive message data size is stored in bytes.	—	System

Processing details

- These instructions performs a message transmission to a remote device station.
- The instructions can be executed to a remote device station, for example NZ2AW1C2AL, that supports the message transmission function.
- The following figure shows how the G(P).RDMSG instruction operates during execution.

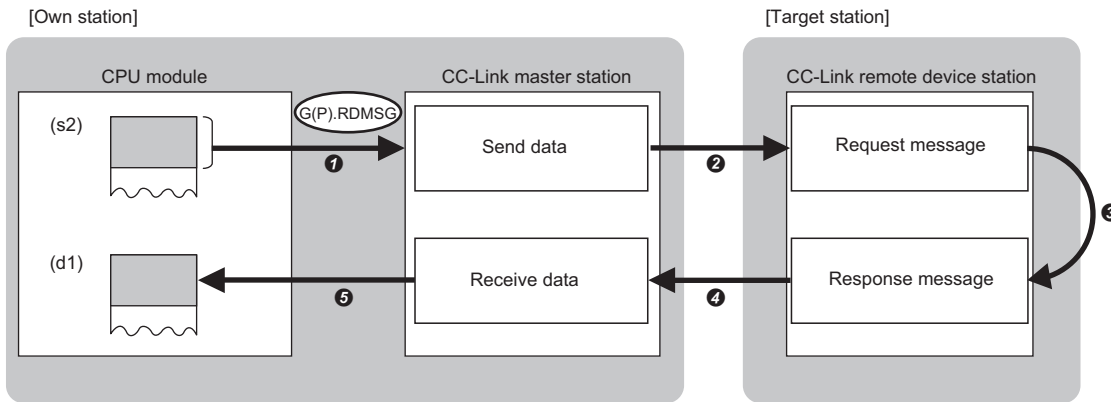

- ➊ The send data specified by (s2) is stored to the master station for the size specified by (s1)+2.
- ➋ The master station sends data to the target station specified by (s1)+1.
- ➌ Processing is performed for the data in the target station specified by (s1)+1.
- ➍ The master station receives a processing result from the target station specified by (s1)+1.
- ➎ The master station stores data in the device specified by (d1) and later, and the device specified by (d2) turns on.

- The completion status of the G(P).RDMSG instruction can be checked with the completion device (d2) and the completion status indication device (d2)+1.

- Completion device (d2)

This device turns on during END processing of the scan where the G(P).RDMSG instruction completes, and turns off during the next END processing.

- Completion status indication device (d2)+1

This device turns on or off depending on the completion status of the G(P).RDMSG instruction.

When completed successfully: The device remains off.

When completed with an error: The device turns on during END processing of the scan where the G(P).RDMSG instruction completes, and turns off during the next END processing.

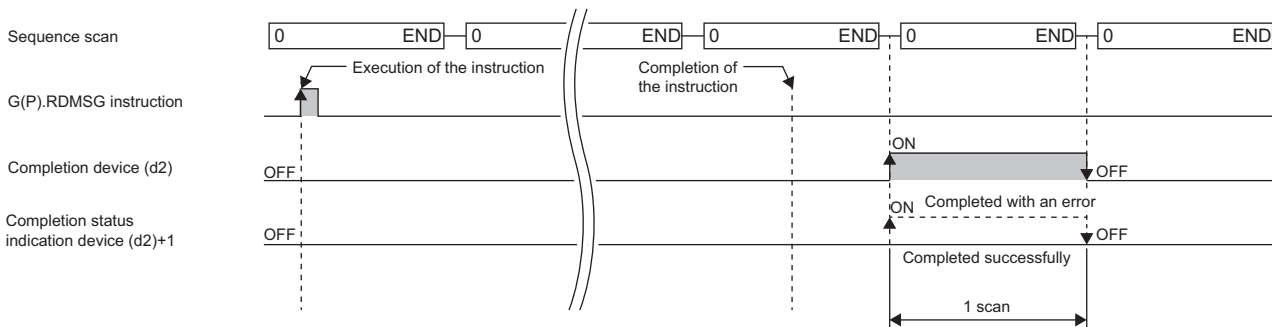

■ Send data size

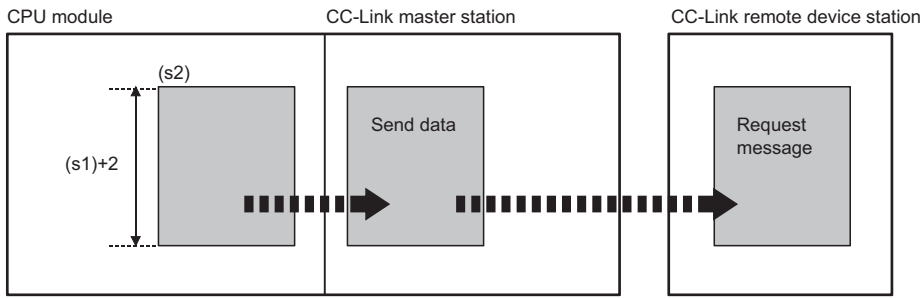

When the number of bytes in the send data ($(s1)+2$) is odd, the lower byte is send as for the last data.

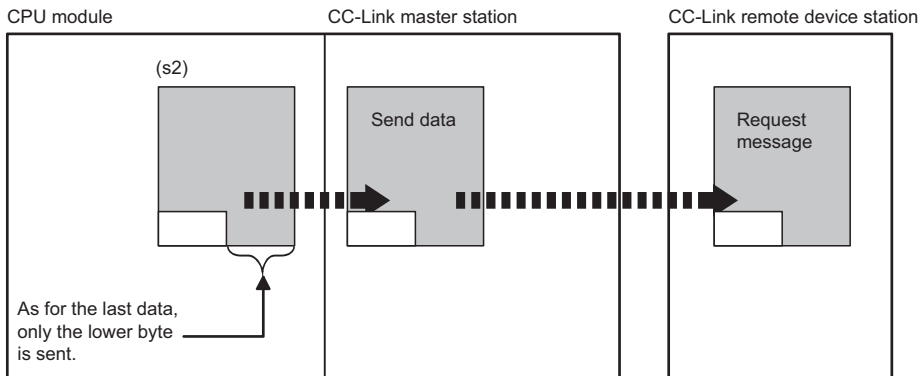

■Receivable data size and receive data size

Set the receivable data size $((s1)+3)$ so that it satisfies the following.

Receivable data size $((s1)+3) \geq$ Receive data size $((s1)+4)$

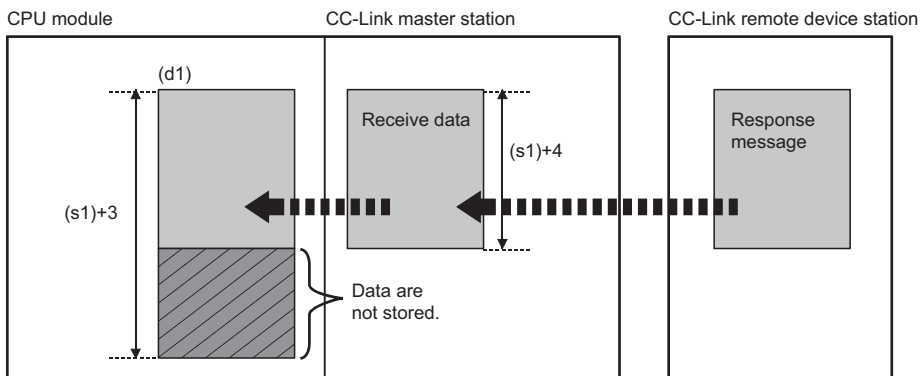

If the receivable data size $((s1)+3)$ is smaller than the receive data size $((s1)+4)$, the master station cannot receive data from the remote device station. The G(P).RDMSG instruction completes with an error (error code: B418H).

- When the number of bytes in the receivable data $((s1)+3)$ is odd

If the receive data has the same number of bytes, 0 is stored in the upper byte of the last data.

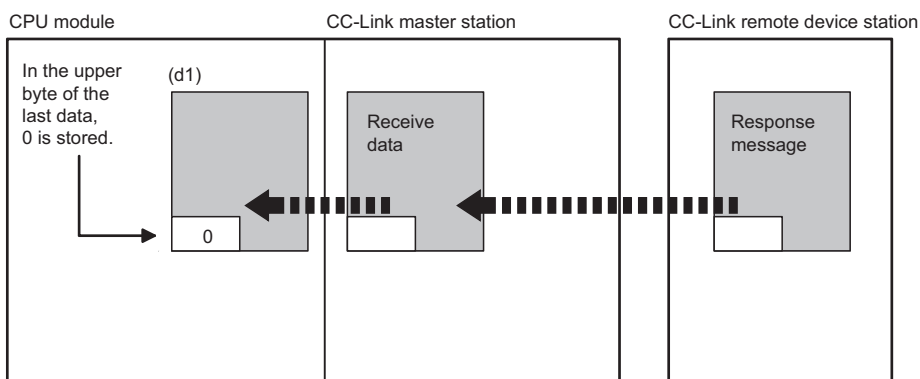

- When the number of bytes in the receive data $((s1)+4)$ is odd

The last receive data is stored in the lower byte of the last data storage area in the device memory. In the upper byte of the last data storage area, 0 is stored.

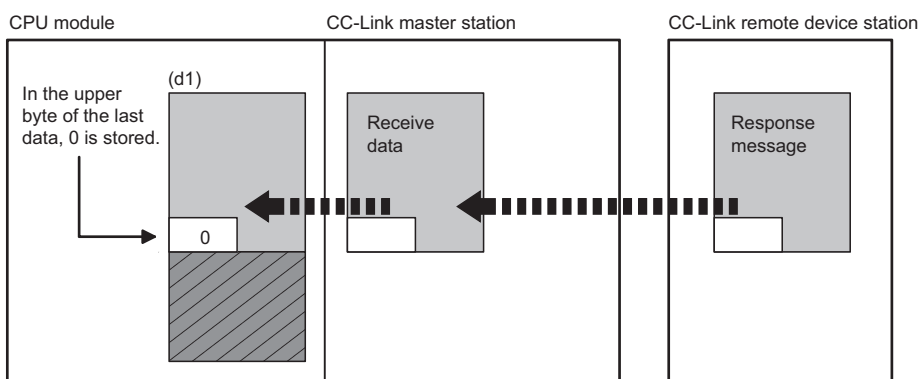

Precautions

- The G(P).RDMSG instruction can be simultaneously executed to two or more remote device stations (up to four stations). Note, however, that only one dedicated instruction can be executed to a single remote device station. If a dedicated instruction is executed before the processing of another instruction has not been completed, the instruction executed later will complete with an error. Create the program so that the next dedicated instruction will start after the completion device turns on, because processing of a dedicated instruction takes several scans until its completion.
- The G(P).RDMSG instruction uses a part or all of remote register that performs cyclic transmission between the master station and the target station in the system. For programming, refer to the manual for the remote device station targeted. Add SW0160 to SW0163 (Remote register use prohibited status) to a program as an interlock.

Operation error

Error code ((s1)+0)	Description
B000H to BFFFH	 MELSEC iQ-R CC-Link System Master/Local Module User's Manual (Application)

9 SERIAL COMMUNICATION INSTRUCTIONS

Point

This chapter describes the instructions used commonly by MELSEC iQ-R series modules. For the instructions when MELSEC-Q series modules are used, refer to the manuals for each module used and create programs. For precautions when using modules, refer to the following.

MELSEC iQ-R Module Configuration Manual

9.1 Sending Data Using the On-Demand Function

G(P).ONDEMAND



These instructions send data of the specified amount from the specified device by using the MC protocol on-demand function.

Ladder	ST
	<pre>ENO:=G_ONDEMAND(EN,U,s1,s2,d); ENO:=GP_ONDEMAND(EN,U,s1,s2,d);</pre>

FBD/LD

Execution condition

Instruction	Execution condition
G.ONDEMAND	
GP.ONDEMAND	

Setting data

Description, range, data type

Operand	Description	Range	Data type	Data type (label)
(U)	Start I/O number (first three digits in four-digit hexadecimal representation) of a module	00H to FEH	16-bit unsigned binary	ANY16
(s1)	Start device where control data is stored	Refer to the control data.	Device name	ANY16 ^{*1}
(s2)	Start device where the send data is stored	—	Device name	ANY16 ^{*1}
(d)	Device that turns on for one scan upon completion of the instruction When the instruction completes with an error, (d)+1 also turns on.	—	Bit	ANYBIT_ARRAY (Number of elements: 2)
EN	Execution condition	—	Bit	BOOL
ENO	Execution result	—	Bit	BOOL

*1 When specifying setting data by using a label, define an array to secure enough operation area and specify an element of the array label.

■Applicable devices

Operand	Bit		Word			Double word		Indirect specification	Constant			Others (U)
	X, Y, M, L, SM, F, B, SB, FX, FY	J□□	T, ST, C, D, W, SD, SW, FD, R, ZR, RD	U□\G□, J□\□, U3E□(H)G□	Z	LT, LST, LC	LZ		K, H	E	\$	
(U)*1	—	—	○*3	—	—	—	○	○	—	—	○	
(s1)	—	—	○*4	—	—	—	○	—	—	—	—	
(s2)	—	—	○*4	—	—	—	○	—	—	—	—	
(d)	○*2	—	○*5	—	—	—	—	—	—	—	—	

*1 Index modification is not available.

*2 FX and FY cannot be used.

*3 RD cannot be used.

*4 FD cannot be used.

*5 T, ST, C, and FD cannot be used.

■Control data

Operand: (s1)				
Device	Item	Description	Setting range	Set by
+0	Send channel	Specifies the send channel. • 1: Channel 1 (CH1 side) • 2: Channel 2 (CH2 side)	1, 2	User
+1	Result of sending	Used to store the result of sending with the G(P).ONDEMAND instruction. • 0: Normal • Other than 0: Error (error code)	—	System
+2	Amount of send data	Specifies the amount of the data to be sent.*1	1 or more	User

*1 The amount of send data must be set in units as specified in the engineering tool. For word specification, set the number of words. For byte specification, set the number of bytes.

Processing details

- By using the on-demand function of MC protocol of the module specified by (U), the data stored in the device specified by (s2) and later is sent according to the control data in the device specified by (s1) and later.

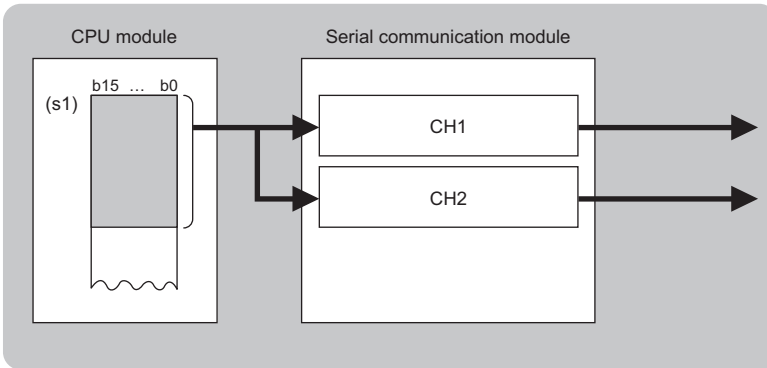

CH: Channel

- The completion status of the G(P).ONDEMAND instruction can be checked with the completion device (d) and the completion status indication device (d)+1.

- Completion device (d)

This device turns on during END processing of the scan where the G(P).ONDEMAND instruction completes, and turns off during the next END processing.

- Completion status indication device (d)+1

This device turns on or off depending on the completion status of the G(P).ONDEMAND instruction.

When completed successfully: The device remains off.

When completed with an error: The device turns on during END processing of the scan where the G(P).ONDEMAND instruction completes, and turns off during the next END processing.

- The following figure shows the operation at completion of the G(P).ONDEMAND instruction.

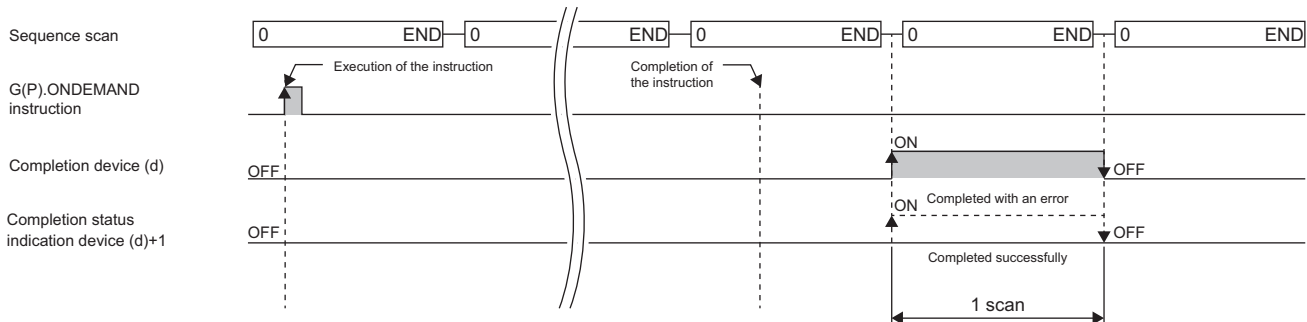

Precautions

- The following table summarizes the processes that take place if another instruction is issued while the G(P).ONDEMAND instruction is active or the G(P).ONDEMAND instruction is issued while another instruction is active with the same channel.

Instruction to execute concurrently*2	Possibility of concurrent execution	Handling for concurrent execution
G(P).ONDEMAND	×	The instruction is ignored and does not start processing until the active instruction completes. Concurrent execution is, however, possible if they use different channels.
ZP.CSET	×	A dedicated instruction concurrent execution error (7FF0H) occurs in the second instruction. Concurrent execution is, however, possible if they use different channels.
G(P).PUTE	○	—
G(P).GETE		
G(P).SPBUSY		
ZP.UINI	×	A dedicated instruction concurrent execution error (7FF0H) occurs in the second instruction.

*2 The following instructions are not available with the same channel as for the G(P).ONDEMAND instruction because they use a communication protocol different from the one used by this instruction. In addition, if these are used with the same channel as for the G(P).ONDEMAND instruction, a communication protocol setting error (7FF2H) will occur. (except for the Z.BUFRCVS instruction).

- G(P).CPRTCL, G(P).OUTPUT, G.INPUT, G(P).BIDOUT, Z.BUFRCVS, and G(P).PRR instructions
- The local device and the file register for each program are not available for setting data.

Operation error

Error code ((s1)+1)	Description
7000H to 7FFFH	 MELSEC IQ-R Serial Communication Module User's Manual (Application)

9.2 Executing the Protocols Registered for the Predefined Protocol Support Function

G(P).CPRTCL



These instructions execute the protocols or special protocols that have been written to the flash ROM by using the communication protocol support function of the engineering tool.

Ladder	ST
	<pre>ENO:=G_CPRTCL(EN,U,n1,n2,s,d); ENO:=GP_CPRTCL(EN,U,n1,n2,s,d);</pre>

FBD/LD

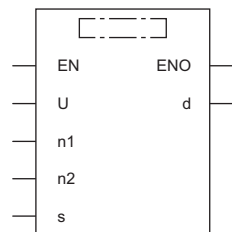

Execution condition

Instruction	Execution condition
G.CPRTCL	
GP.CPRTCL	

Setting data

Description, range, data type

Operand	Description	Range	Data type	Data type (label)
(U)	Start I/O number (first three digits in four-digit hexadecimal representation) of a module	00H to FEH	16-bit unsigned binary	ANY16
(n1)	Channel to communicate with the external device • 1: Channel 1 (CH1 side) • 2: Channel 2 (CH2 side)	1, 2	16-bit unsigned binary	ANY16
(n2)	Number of protocols to be executed consecutively (1 to 8)	1 to 8	16-bit unsigned binary	ANY16
(s)	Start device where control data is stored	Refer to the control data.	Device name	ANY16 ^{*1}
(d)	Device that turns on for one scan upon completion of the instruction When the instruction completes with an error, (d)+1 also turns on.	—	Bit	ANYBIT_ARRAY (Number of elements: 2)
EN	Execution condition	—	Bit	BOOL
ENO	Execution result	—	Bit	BOOL

*1 When specifying setting data by using a label, define an array to secure enough operation area and specify an element of the array label.

■Applicable devices

Operand	Bit		Word				Double word		Indirect specification	Constant			Others (U)
	X, Y, M, L, SM, F, B, SB, FX, FY	J□□	T, ST, C, D, W, SD, SW, FD, R, ZR, RD	U□\G□, J□□, U3E□(H)G□	Z	LT, LST, LC	LZ	K, H, E, \$					
(U)* ¹	—	—	○	—	—	—	—	○	○	—	—	○	
(n1)	—	—	○* ³	—	—	—	—	○	○	—	—	—	
(n2)	—	—	○* ³	—	—	—	—	○	○	—	—	—	
(s)	—	—	○* ³	—	—	—	—	○	—	—	—	—	
(d)	○* ²	—	○* ³	—	—	—	—	—	—	—	—	—	

*1 Index modification is not available.

*2 FX and FY cannot be used.

*3 FD cannot be used.

■Control data

Operand: (s)				
Device	Item	Description	Setting range	Set by
+0	Execution result	Used to store the execution result of the G(P).CPRTCL instruction. If two or more protocols are executed, the execution result of the last protocol will be stored. ^{*1} • 0: Normal • Other than 0: Error (error code)	—	System
+1	Resulting number of executed protocols	Used to store the number of actually executed protocols. Also for the protocols that caused an error, the execution result of the last protocol will be stored. If an error is included in the setting data or the control data setting details, "0" will be stored.	1 to 8	System
+2	Execution protocol number specification	Sets the number of the first protocol or special protocol to be executed. ^{*2}	1 to 128, 201 to 207	User
⋮		⋮		
+9		Sets the number of the eighth protocol or special protocol to be executed. ^{*2}		
+10	Matched receive packet number	Used to store the matched receive packet number if the communication type of the first protocol executed is "Send only" or "Send and receive". If the first protocol caused an error during its execution, "0" will be stored. If a special protocol is executed, "0" will be stored. ^{*2}	0, 1 to 16	System
⋮		⋮		
+17		Used to store the matched receive packet number if the communication type of the eighth protocol executed is "Send only" or "Send and receive". If the eighth protocol caused an error during its execution, "0" will be stored. If a special protocol is executed, "0" will be stored. ^{*2}		

*1 If the n-th protocol caused an error during its execution while two or more protocols are being executed, none of the subsequent protocols will be executed.

*2 For details on the special protocols, refer to the following.

📖 Page 377 Special protocol

Processing details

- The protocol setting data written to the flash ROM is executed using the module specified by (U). All the protocols to be executed follow the contents of the control data that has been stored in the device specified by (s) and later. The channel specified by (n1) is used.
- One attempt of the instruction consecutively executes the specified number of protocols (by (n2); maximum 8).
- The completion status of the G(P).CPRTCL instruction can be checked with the completion device (d) and the completion status indication device (d)+1.

- Completion device (d)

This device turns on during END processing of the scan where the G(P).CPRTCL instruction completes, and turns off during the next END processing.

- Completion status indication device (d)+1

This device turns on or off depending on the completion status of the G(P).CPRTCL instruction.

When completed successfully: The device remains off.

When completed with an error: The device turns on during END processing of the scan where the G(P).CPRTCL instruction completes, and turns off during the next END processing.

- The following figure shows the operation at the completion of the G(P).CPRTCL instruction.

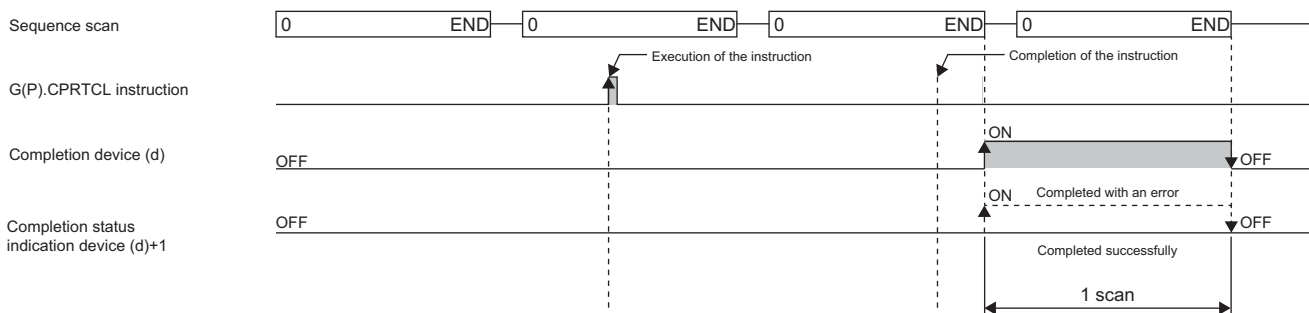

Point

The program execution status can be checked with the buffer memory (address: 4041H/4051H).

■Canceling protocol execution

A protocol can be canceled during its execution.

This function forcibly terminates the protocol being executed when a communication error occurs with the external device.

The function can be executed in the predefined protocol mode only.

- How to cancel the protocol execution

A cancellation can be requested using a sequence program.

Use the following buffer memory areas.

Address (decimal (hexadecimal))		Name	Set value
CH1	CH2		
16448 (4040H)	16464 (4050H)	Protocol cancellation specification	0: No cancellation specified 1: Cancellation requested (by user) 2: Canceled (by the C24)

- Operation after the cancellation is requested

[Operation of the dedicated instruction (G(P).CPRTCL)]

The instruction completes with an error, and the error code is stored in (s)+0 (Execution result). If multiple protocols are being executed sequentially, the cancellation-target protocol ('n'th protocol) is forcibly terminated, and the subsequent protocols are not executed.

[Operation of the C24]

If the function is executed (a cancellation is requested) while no protocol is being executed, the C24 performs no processing.

If the function is executed in the mode other than the predefined protocol mode, the value in the corresponding buffer memory area is ignored.

- After the protocol whose communication type is "Send and receive" is canceled, clear the receive data. When data is received after cancellation, the receive data is held in the OS area (receive data area). This occurs when a response from the external device is slow. For how to clear receive data, refer to Page 400 Clearing Receive Data.
- While the value set to "Protocol cancellation specification" is 1 (Cancellation requested), another G(P).CPRTCL instruction cannot be executed.

■ Special protocol

The following functions are available by executing special protocols with the G(P).CPRTCL instruction.

Functions	Description
Clearing receive data	Enables the receive data to be cleared from the OS area.
Send/receive data monitoring start/stop	Specifies the start or stop of send/receive data monitoring. When special protocols 202 or 203 is executed, the module sets the monitor start instruction "0001H" or the monitor stop instruction "0000H" for the send/receive data monitoring specification (address: 2018H, 2118H).
RS/DTR signal status specification	Specifies the on/off state of the RS(RTS) and ER(DTR) signals. When one of special protocols 204 to 207 is executed, the module turns on/off the bit corresponding to the RS/DTR signal status specification (address: 92H/132H). For details on the RS/DTR signal status specification, refer to the following.  MELSEC iQ-R Serial Communication Module User's Manual (Application)

In control data (s)+2 to (s)+9 of the G(P).CPRTCL instruction, specify the number of the special protocol of the function to be executed.

Functions	Special protocol number	Type	Keyword*1
Clearing receive data	201	Clearing receive data	Receive Data Clear
Send/receive data monitoring start/stop	202	Start send/receive data monitoring	Send/Recv Monitor Start
	203	Stop send/receive data monitoring	Send/Recv Monitor Stop
RS/DTR signal status specification	204	Turn on the ER (DTR) signal	DTR ON
	205	Turn off the ER (DTR) signal	DTR OFF
	206	Turn on the RS (RTS) signal	RS ON
	207	Turn off the RS (RTS) signal	RS OFF

*1 When a special protocol is executed, the keyword is defined as the character string that is stored in the protocol name of the protocol execution history.

Precautions

- The following table summarizes the processes that take place if another instruction is issued while the G(P).CPRTCL instruction is active or the G(P).CPRTCL instruction is issued while another instruction is active with the same channel.

Instruction to execute concurrently ^{*2}	Possibility of concurrent execution	Handling for concurrent execution
G(P).CPRTCL	×	The instruction is ignored and does not start processing until the active instruction completes. Concurrent execution is, however, possible if they use different channels.
G(P).PUTE	○	—
G(P).GETE		
G(P).SPBUSY		
ZP.UINI	×	A dedicated instruction concurrent execution error (7FF0H) occurs in the second instruction.

*2 The following instructions are not available with the same channel as for the G(P).CPRTCL instruction because they use a communication protocol different from the one used by this instruction. In addition, if these are used with the same channel as for the G(P).CPRTCL instruction, a communication protocol setting error (7FF2H) will occur (except for the Z.BUFRCVS instruction).

- G(P).ONDEMAND, G(P).OUTPUT, G.INPUT, G(P).BIDOUT, G(P).BIDIN, Z.BUFRCVS, G(P).PRR, and ZP.CSET instructions
- The local device and the file register for each program are not available for setting data.

Operation error

Error code ((s)+0)	Description
7000H to 7FFFH	 MELSEC iQ-R Serial Communication Module User's Manual (Application)

9.3 Sending Data Using the Nonprocedural Protocol

G(P).OUTPUT

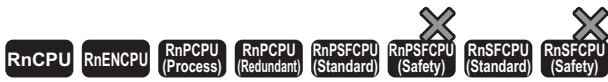

These instructions send data in a user-defined message format by using the nonprocedural protocol.

Ladder	ST
	<pre>ENO:=G_OUTPUT(EN,U,s1,s2,d); ENO:=GP_OUTPUT(EN,U,s1,s2,d);</pre>

FBD/LD

■ Execution condition

Instruction	Execution condition
G.OUTPUT	
GP.OUTPUT	

Setting data

■ Description, range, data type

Operand	Description	Range	Data type	Data type (label)
(U)	Start I/O number (first three digits in four-digit hexadecimal representation) of a module	00H to FEH	16-bit unsigned binary	ANY16
(s1)	Start device where control data is stored	Refer to the control data.	Device name	ANY16 ^{*1}
(s2)	Start device where the send data is stored	—	Device name	ANY16 ^{*1}
(d)	Device that turns on for one scan upon completion of the instruction When the instruction completes with an error, (d)+1 also turns on.	—	Bit	ANYBIT_ARRAY (Number of elements: 2)
EN	Execution condition	—	Bit	BOOL
ENO	Execution result	—	Bit	BOOL

*1 When specifying setting data by using a label, define an array to secure enough operation area and specify an element of the array label.

■Applicable devices

Operand	Bit		Word			Double word		Indirect specification	Constant			Others (U)
	X, Y, M, L, SM, F, B, SB, FX, FY	J□□	T, ST, C, D, W, SD, SW, FD, R, ZR, RD	U□\G□, J□\□, U3E□(H)G□	Z	LT, LST, LC	LZ		K, H	E	\$	
(U)*1	—	—	○*3	—	—	—	○	○	—	—	○	
(s1)	—	—	○*4	—	—	—	○	—	—	—	—	
(s2)	—	—	○*4	—	—	—	○	—	—	—	—	
(d)	○*2	—	○*5	—	—	—	—	—	—	—	—	

*1 Index modification is not available.

*2 FX and FY cannot be used.

*3 RD cannot be used.

*4 FD cannot be used.

*5 T, ST, C, and FD cannot be used.

■Control data

Operand: (s1)				
Device	Item	Description	Setting range	Set by
+0	Send channel	Specifies the send channel. • 1: Channel 1 (CH1 side) • 2: Channel 2 (CH2 side)	1, 2	User
+1	Result of sending	Used to store the result of sending with the G(P).OUTPUT instruction. • 0: Normal • Other than 0: Error (error code)	—	System
+2	Amount of send data	Specifies the amount of the data to be sent.*1	1 or more	User

*1 The amount of the data to be sent must be set in units as specified in the engineering tool. For byte specification, set the number of bytes. For word specification, set the number of words.

Processing details

- By using the nonprocedural protocol of the module specified by (U), the data stored in the device specified by (s2) and later is sent according to the control data in the device specified by (s1) and later.

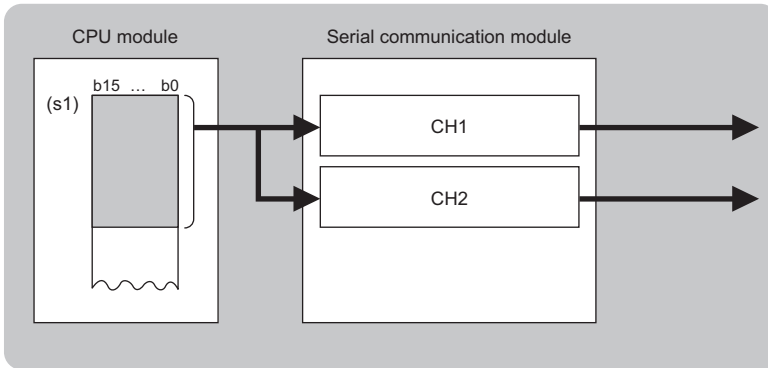

CH: Channel

- The completion status of the G(P).OUTPUT instruction can be checked with the completion device (d) and the completion status indication device (d)+1.

- Completion device (d)

This device turns on during END processing of the scan where the G(P).OUTPUT instruction completes, and turns off during the next END processing.

- Completion status indication device (d)+1

This device turns on or off depending on the completion status of the G(P).OUTPUT instruction.

When completed successfully: The device remains off.

When completed with an error: The device turns on during END processing of the scan where the G(P).OUTPUT instruction completes, and turns off during the next END processing.

- The following figure shows the operation at the completion of the G(P).OUTPUT instruction.

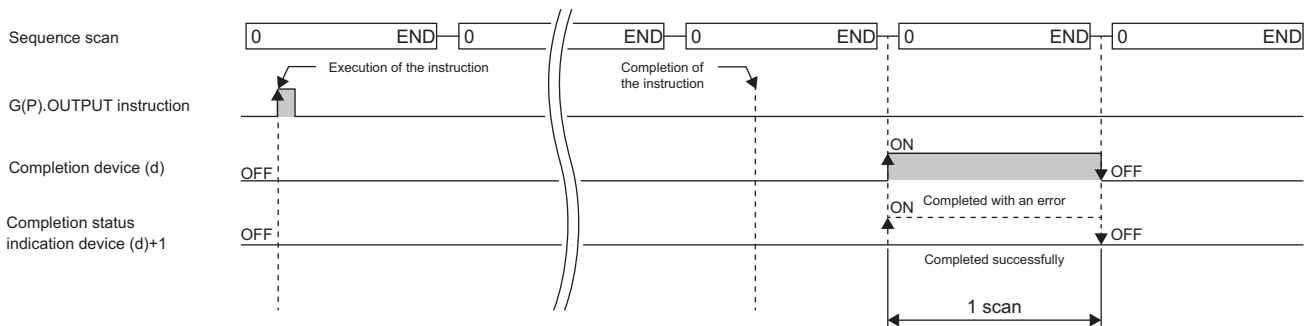

Precautions

- The following table summarizes the processes that take place if another instruction is issued while the G(P).OUTPUT instruction is active or the G(P).OUTPUT instruction is issued while another instruction is active with the same channel.

Instruction to execute concurrently ^{*2}	Possibility of concurrent execution	Handling for concurrent execution
G(P).OUTPUT	×	The instruction is ignored and does not start processing until the active instruction completes. Concurrent execution is, however, possible if they use different channels.
G.INPUT	○	—
G(P).PRR	×	A dedicated instruction concurrent execution error (7FF0H) occurs in the second instruction. Concurrent execution is, however, possible if they use different channels.
ZP.CSET		
G(P).PUTE	○	—
G(P).GETE		
Z.BUFRCVS		
G(P).SPBUSY		
ZP.UINI	×	A dedicated instruction concurrent execution error (7FF0H) occurs in the second instruction.

*2 The following instructions are not available with the same channel as for the G(P).OUTPUT instruction because they use a communication protocol different from the one used by this instruction. In addition, if these are used with the same channel as for the G(P).OUTPUT instruction, a communication protocol setting error (7FF2H) will occur.

- G(P).ONDEMAND, G(P).CPRTCL, G(P).BIDOUT, and G(P).BIDIN instructions
- The local device and the file register for each program are not available for setting data.

Operation error

Error code ((s1)+1)	Description
7000H to 7FFFH	 MELSEC iQ-R Serial Communication Module User's Manual (Application)

9.4 Receiving Data Using the Nonprocedural Protocol

G.INPUT

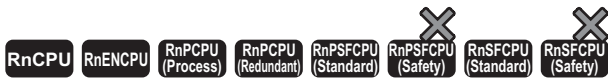

This instruction receives data in a user-defined message format by using the nonprocedural protocol.

Ladder	ST
	<pre>ENO:=G_INPUT(EN,U,s,d1,d2);</pre>

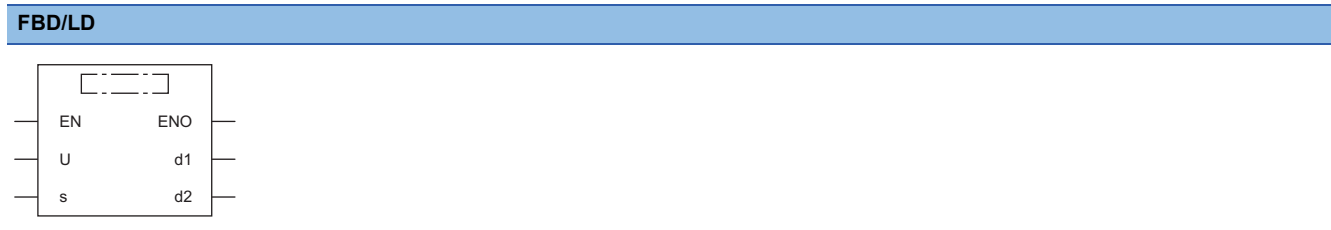

Execution condition

Instruction	Execution condition
G.INPUT	

Setting data

Description, range, data type

Operand	Description	Range	Data type	Data type (label)
(U)	Start I/O number (first three digits in four-digit hexadecimal representation) of a module	00H to FEH	16-bit unsigned binary	ANY16
(s)	Start device where control data is stored	Refer to the control data.	Device name	ANY16*1
(d1)	Start device for storing the receive data	—	Device name	ANY16*1
(d2)	Device that turns on for one scan upon completion of the instruction When the instruction completes with an error, (d2)+1 also turns on.	—	Bit	ANYBIT_ARRAY (Number of elements: 2)
EN	Execution condition	—	Bit	BOOL
ENO	Execution result	—	Bit	BOOL

*1 When specifying setting data by using a label, define an array to secure enough operation area and specify an element of the array label.

Applicable devices

Operand	Bit	Word			Double word		Indirect specification	Constant			Others (U)
	X, Y, M, L, SM, F, B, SB, FX, FY	J□\□	T, ST, C, D, W, SD, SW, FD, R, ZR, RD	U□\G□, J□\□, U3E□(H)\G□	Z	LT, LST, LC		LZ	K, H	E	
(U)*1	—	—	○*3	—	—	—	○	○	—	—	○
(s)	—	—	○*4	—	—	—	○	—	—	—	—
(d1)	—	—	○*4	—	—	—	○	—	—	—	—
(d2)	○*2	—	○*5	—	—	—	—	—	—	—	—

*1 Index modification is not available.
 *2 FX and FY cannot be used.
 *3 RD cannot be used.
 *4 FD cannot be used.
 *5 T, ST, C, and FD cannot be used.

Control data

Operand: (s)				
Device	Item	Description	Setting range	Set by
+0	Receive channel	Specifies the receive channel. • 1: Channel 1 (CH1 side) • 2: Channel 2 (CH2 side)	1, 2	User
+1	Result of receiving	Used to store the result of receiving with the G.INPUT instruction. • 0: Normal • Other than 0: Error (error code)	—	System
+2	Amount of receive data	Stores the number of data received.*1	—	System
+3	Allowable amount of receive data	Sets the allowable number of words of receive data that can be stored in (d1).	1 or more	User

*1 The amount of the data to be received is set in units as specified in the engineering tool. For byte specification, the number of bytes is set. For word specification, the number of words is set.

Processing details

- The data received through the nonprocedural protocol of the module specified by (U) is stored in the device specified by (d1) and later, according to the control data in the device specified by (s) and later.
- If the amount of actually received data is larger than the allowable amount of receive data specified by (s)+3, the data for the allowable amount of receive data is only stored with the remaining receive data discarded. In this case, the allowable amount of receive data is stored in the amount of receive data (s)+2. (the instruction completes successfully).
- The completion status of the G.INPUT instruction can be checked with the completion device (d2) and the completion status indication device (d2)+1.

- Completion device (d2)

This device turns on during END processing of the scan where the G.INPUT instruction completes, and turns off during the next END processing.

- Completion status indication device (d2)+1

This device turns on or off depending on the completion status of the G.INPUT instruction.

When completed successfully: The device remains off.

When completed with an error: The device turns on during END processing of the scan where the G.INPUT instruction completes, and turns off during the next END processing.

- The following figure shows the operation at the completion of the G.INPUT instruction.

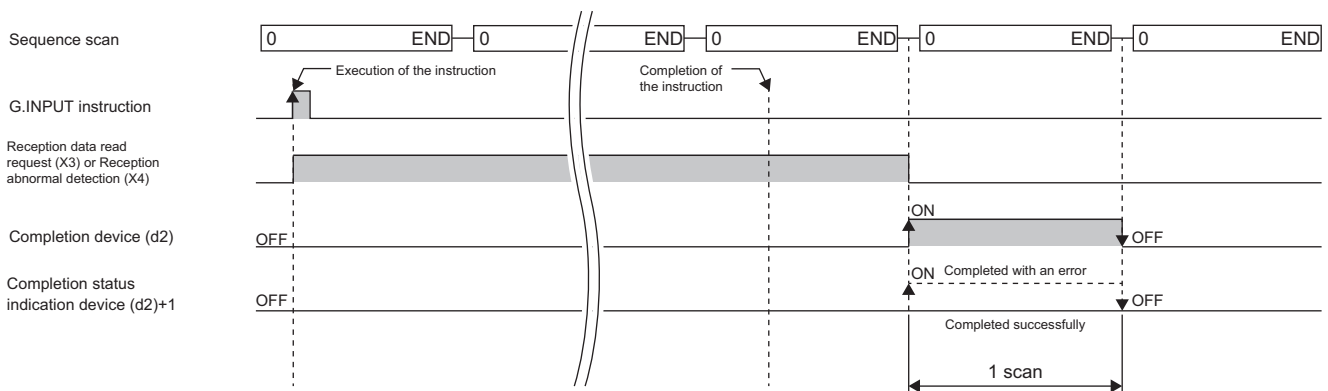

Precautions

- Any command of G.INPUT cannot be pulse converted.
- G.INPUT must be executed while the I/O signal read request signal is on.
- The following table summarizes the processes that take place if another instruction is issued while the G.INPUT instruction is active or the G.INPUT instruction is issued while another instruction is active with the same channel.

Instruction to execute concurrently ^{*2}	Possibility of concurrent execution	Handling for concurrent execution
G(P).OUTPUT	○	—
G(P).PRR		
G.INPUT	×	The instruction is ignored and does not start processing until the active instruction completes. Concurrent execution is, however, possible if they use different channels.
ZP.CSET	See the right	<ul style="list-style-type: none"> • If the G.INPUT and ZP.CSET instructions are issued in this order A dedicated instruction concurrent execution error (7FF0H) occurs in the ZP.CSET instruction. Concurrent execution is, however, possible if they use different channels. • If the ZP.CSET and G.INPUT instructions are issued in this order Concurrent execution is possible.
G(P).PUTE	○	—
G(P).GETE		
Z.BUFRCVS	×	The G.INPUT and Z.BUFRCVS instructions cannot be used simultaneously. Concurrent execution is, however, possible if they use different channels.
G(P).SPBUSY	○	—
ZP.UINI	×	A dedicated instruction concurrent execution error (7FF0H) occurs in the second instruction.

*2 The following instructions are not available with the same channel as for the G.INPUT instruction because they use a communication protocol different from the one used by this instruction. In addition, if these are used with the same channel as for the G.INPUT instruction, a communication protocol setting error (7FF2H) will occur.

- G(P).ONDEMAND, G(P).CPRTCL, G(P).BIDOUT, and G(P).BIDIN instructions
- The local device and the file register for each program are not available for setting data.

Operation error

Error code ((s)+1)	Description
7000H to 7FFFH	 MELSEC iQ-R Serial Communication Module User's Manual (Application)

9.5 Sending Data Using the Bidirectional Protocol

G(P).BIDOUT

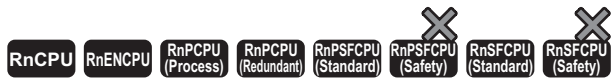

These instructions send data using the bidirectional protocol.

Ladder	ST
	<pre>ENO:=G_BIDOUT(EN,U,s1,s2,d); ENO:=GP_BIDOUT(EN,U,s1,s2,d);</pre>

FBD/LD

■ Execution condition

Instruction	Execution condition
G.BIDOUT	
GP.BIDOUT	

Setting data

■ Description, range, data type

Operand	Description	Range	Data type	Data type (label)
(U)	Start I/O number (first three digits in four-digit hexadecimal representation) of a module	00H to FEH	16-bit unsigned binary	ANY16
(s1)	Start device where control data is stored	Refer to the control data.	Device name	ANY16 ^{*1}
(s2)	Start device where the send data is stored	—	Device name	ANY16 ^{*1}
(d)	Device that turns on for one scan upon completion of the instruction When the instruction completes with an error, (d)+1 also turns on.	—	Bit	ANYBIT_ARRAY (Number of elements: 2)
EN	Execution condition	—	Bit	BOOL
ENO	Execution result	—	Bit	BOOL

*1 When specifying setting data by using a label, define an array to secure enough operation area and specify an element of the array label.

■Applicable devices

Operand	Bit		Word				Double word		Indirect specification	Constant			Others (U)
	X, Y, M, L, SM, F, B, SB, FX, FY	J□□	T, ST, C, D, W, SD, SW, FD, R, ZR, RD	U□V□, J□□□, U3E□(H)G□	Z	LT, LST, LC	LZ	K, H		E	\$		
(U)*1	—	—	○*3	—	—	—	—	○	○	—	—	○	
(s1)	—	—	○*4	—	—	—	—	○	—	—	—	—	
(s2)	—	—	○*4	—	—	—	—	○	—	—	—	—	
(d)	○*2	—	○*5	—	—	—	—	—	—	—	—	—	

*1 Index modification is not available.

*2 FX and FY cannot be used.

*3 RD cannot be used.

*4 FD cannot be used.

*5 T, ST, C, and FD cannot be used.

■Control data

Operand: (s1)				
Device	Item	Description	Setting range	Set by
+0	Send channel	Specifies the send channel. • 1: Channel 1 (CH1 side) • 2: Channel 2 (CH2 side)	1, 2	User
+1	Result of sending	Used to store the result of sending with the G(P).BIDOUT instruction. • 0: Normal • Other than 0: Error (error code)	—	System
+2	Amount of send data	Specifies the amount of the data to be sent.*1	1 or more	User

*1 The amount of the data to be sent must be set in units as specified in the engineering tool. For byte specification, set the number of bytes. For word specification, set the number of words.

Processing details

- By using the bidirectional protocol of the module specified by (U), the data stored in the device specified by (s2) and later is sent according to the control data in the device specified by (s1) and later.
- The completion status of the G(P).BIDOUT instruction can be checked with the completion device (d) and the completion status indication device (d)+1.

- Completion device (d)

This device turns on during END processing of the scan where the G(P).BIDOUT instruction completes, and turns off during the next END processing.

- Completion status indication device (d)+1

This device turns on or off depending on the completion status of the G(P).BIDOUT instruction.

When completed successfully: The device remains off.

When completed with an error: The device turns on during END processing of the scan where the G(P).BIDOUT instruction completes, and turns off during the next END processing.

- The following figure shows the operation at the completion of the G(P).BIDOUT instruction.

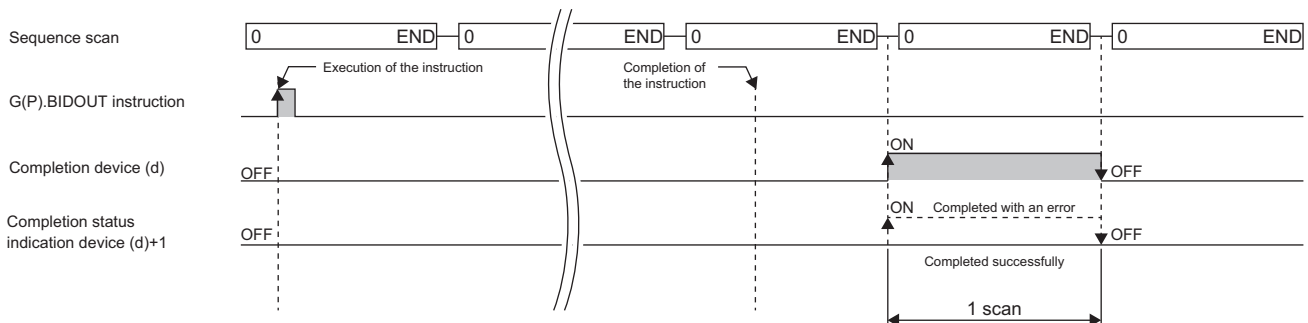

Precautions

- The following table summarizes the processes that take place if another instruction is issued while the G(P).BIDOUT instruction is active or the G(P).BIDOUT instruction is issued while another instruction is active with the same channel.

Instruction to execute concurrently ^{*2}	Possibility of concurrent execution	Handling for concurrent execution
G(P).BIDOUT	×	The instruction is ignored and does not start processing until the active instruction completes. Concurrent execution is, however, possible if they use different channels.
G(P).BIDIN	○	—
ZPCSET	×	The instruction is ignored and does not start processing until the active instruction completes. Concurrent execution is, however, possible if they use different channels.
G(P).PUTE	○	—
G(P).GETE		
Z.BUFRCVS		
G(P).SPBUSY		
ZP.UINI	×	A dedicated instruction concurrent execution error (7FF0H) occurs in the second instruction.

*2 The following instructions are not available with the same channel as for the G(P).BIDOUT instruction because they use a communication protocol different from the one used by this instruction. In addition, if these are used with the same channel as for the G(P).BIDOUT instruction, a communication protocol setting error (7FF2H) will occur.

- G(P).ONDEMAND, G(P).CPRTCL, G(P).BIDOUT, and G(P).BIDIN instructions

Operation error

Error code ((s1)+1)	Description
7000H to 7FFFH	 MELSEC iQ-R Serial Communication Module User's Manual (Application)

9.6 Receiving Data Using the Bidirectional Protocol

G(P).BIDIN

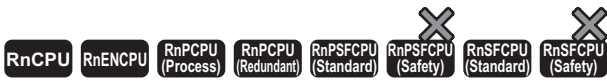

These instructions receive data using the bidirectional protocol.

Ladder	ST
	<pre>ENO:=G_BIDIN(EN,U,s,d1,d2); ENO:=GP_BIDIN(EN,U,s,d1,d2);</pre>

FBD/LD

Execution condition

Instruction	Execution condition
G.BIDIN	
GP.BIDIN	

Setting data

Description, range, data type

Operand	Description	Range	Data type	Data type (label)
(U)	Start I/O number (first three digits in four-digit hexadecimal representation) of a module	00H to FEH	16-bit unsigned binary	ANY16
(s)	Start device where control data is stored	Refer to the control data.	Device name	ANY16 ^{*1}
(d1)	Start device for storing the receive data	—	Device name	ANY16 ^{*1}
(d2)	Device that turns on for one scan upon completion of the instruction When the instruction completes with an error, (d2)+1 also turns on.	—	Bit	ANYBIT_ARRAY (Number of elements: 2)
EN	Execution condition	—	Bit	BOOL
ENO	Execution result	—	Bit	BOOL

*1 When specifying setting data by using a label, define an array to secure enough operation area and specify an element of the array label.

■Applicable devices

Operand	Bit		Word				Double word		Indirect specification	Constant			Others (U)
	X, Y, M, L, SM, F, B, SB, FX, FY	J□□	T, ST, C, D, W, SD, SW, FD, R, ZR, RD	U□VG□, J□□□, U3E□(H)G□	Z	LT, LST, LC	LZ	K, H, E, \$					
(U)*1	—	—	○*3	—	—	—	○	—	○	—	—	○	
(s)	—	—	○*4	—	—	—	○	—	—	—	—	—	
(d1)	—	—	○*4	—	—	—	○	—	—	—	—	—	
(d2)	○*2	—	○*5	—	—	—	—	—	—	—	—	—	

*1 Index modification is not available.

*2 FX and FY cannot be used.

*3 RD cannot be used.

*4 FD cannot be used.

*5 T, ST, C, and FD cannot be used.

■Control data

Operand: (s)				
Device	Item	Description	Setting range	Set by
+0	Receive channel	Specifies the receive channel. • 1: Channel 1 (CH1 side) • 2: Channel 2 (CH2 side)	1, 2	User
+1	Result of receiving	Used to store the result of sending with the G(P).BIDIN instruction. • 0: Normal • Other than 0: Error (error code)	—	System
+2	Amount of receive data	Stores the number of data received.	—	System
+3	Allowable amount of receive data	Sets the allowable number of words of receive data that can be stored in (d1). ^{*1}	1 or more	User

*1 The amount of the data to be received must be set in units as specified in the engineering tool. For byte specification, set the number of bytes. For word specification, set the number of words.

Processing details

- The data received using the bidirectional protocol of the module specified by (U) is stored in the device specified by (d1) and later, according to the control data in the device specified by (s) and later.
- The completion status of the G(P).BIDIN instruction can be checked with the completion device (d2) and the completion status indication device (d2)+1.

• Completion device (d2)

This device turns on during END processing of the scan where the G(P).BIDIN instruction completes, and turns off during the next END processing.

• Completion status indication device (d2)+1

Unchanged from off.

- The following figure shows the operation at the completion of the G(P).BIDIN instruction.

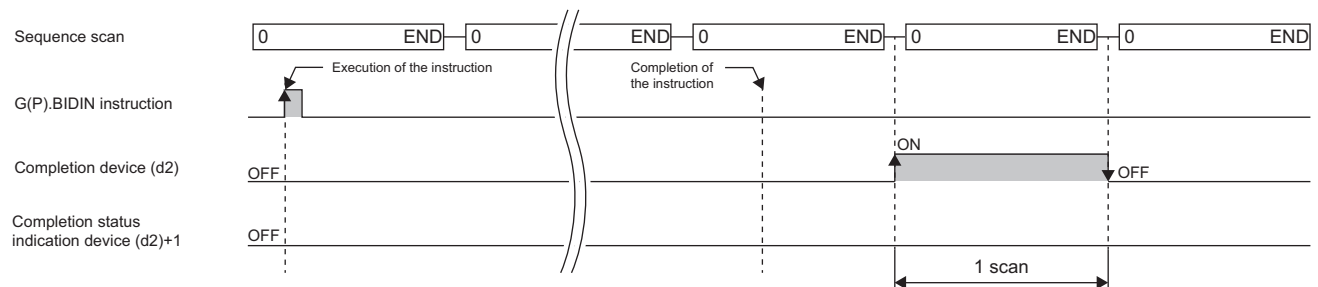

Precautions

- The following table summarizes the processes that take place if another instruction is issued while the G(P).BIDIN instruction is active or the G(P).BIDIN instruction is issued while another instruction is active with the same channel.

Instruction to execute concurrently*2	Possibility of concurrent execution	Handling for concurrent execution
G(P).BIDOUT	×	—
G(P).BIDIN	○	The instruction is ignored and does not start processing until the active instruction completes. Concurrent execution is, however, possible if they use different channels.
Z.PCSET	×	A dedicated instruction concurrent execution error (7FF0H) occurs in the second instruction. Concurrent execution is, however, possible if they use different channels.
G(P).PUTE	○	—
G(P).GETE		
Z.BUFRCVS	×	Concurrent execution of the G(P).BIDIN and Z.BUFRCVS instructions is not possible. Concurrent execution is, however, possible if they use different channels.
G(P).SPBUSY	○	—
ZP.UINI	×	A dedicated instruction concurrent execution error (7FF0H) occurs in the second instruction.

*2 The following instructions are not available with the same channel as for the G(P).BIDIN instruction because they use a communication protocol different from the one used by this instruction. In addition, if these are used with the same channel as for the G(P).BIDIN instruction, a communication protocol setting error (7FF2H) will occur.

- G(P).ONDEMAND, G(P).CPRTCL, G(P).OUTPUT, G.INPUT, and G(P).PRR instructions

Operation error

Error code ((s)+1)	Description
7000H to 7FFFH	 MELSEC iQ-R Serial Communication Module User's Manual (Application)

9.7 Reading the Data Send/Receive Status

G(P).SPBUSY



These instructions read the send/receive status of data using the instruction.

Ladder	ST
	<pre>ENO:=G_SPBUSY(EN,U,d); ENO:=GP_SPBUSY(EN,U,d);</pre>

FBD/LD

Execution condition

Instruction	Execution condition
G.SPBUSY	
GP.SPBUSY	

Setting data

Description, range, data type

Operand	Description	Range	Data type	Data type (label)
(U)	Start I/O number (first three digits in four-digit hexadecimal representation) of a module	00H to FEH	16-bit unsigned binary	ANY16
(d)	Start device for storing the read communication status	—	Device name	ANY16
EN	Execution condition	—	Bit	BOOL
ENO	Execution result	—	Bit	BOOL

Applicable devices

Operand	Bit	Word			Double word		Indirect specification	Constant			Others (U)
	X, Y, M, L, SM, F, B, SB, FX, FY	J□□	T, ST, C, D, W, SD, SW, FD, R, ZR, RD	U□\G□, J□□□, U3E□\(\H)G□	Z	LT, LST, LZ		LC	K, H	E	
(U)*1	—	—	○	—	—	—	○	○	—	—	○
(d)	—	—	○*2	—	—	—	○	—	—	—	—

*1 Index modification is not available.

*2 FD cannot be used.

Processing details

- The execution status of the instruction to the module specified by the start I/O number is read and stored in the device specified by (d) and later.
- In the associated bit of the device specified by (d), "1" is stored when each instruction starts its processing, and "0" is stored when the instruction completes its processing. Completion of processing of each instruction is at the time when the completion flag of the instruction changes from on to off.

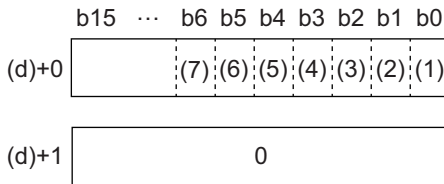

- (1) Execution status of the G(P).ONDEMAND, G(P).OUTPUT, G(P).PRR, or G(P).BIDOUT instruction for channel 1
 (2) Execution status of the G.INPUT or G(P).BIDIN instruction for channel 1
 (3) Execution status of the G(P).ONDEMAND, G(P).OUTPUT, G(P).PRR, or G(P).BIDOUT instruction for channel 2
 (4) Execution status of the G.INPUT or G(P).BIDIN instruction for channel 2
 (5) Execution status of the G(P).GETE or G(P).PUTE instruction
 (6) Execution status of the G(P).CPRTCL instruction for channel 1
 (7) Execution status of the G(P).CPRTCL instruction for channel 2

- If the instruction has been set to be executed while being on, the G(P).SPBUSY instruction operates every scan while the read instruction is on; if the instruction has been set to be executed at the rise, it operates only one scan when the read instruction rises from off to on.
- While the G(P).SPBUSY instruction is active, another instruction can be executed. In addition, while another instruction is active, the G(P).SPBUSY instruction can be executed.

Operation error

Error code (SD0)	Description
4000H to 4FFFH	📖 MELSEC IQ-R CPU Module User's Manual (Application)

9.8 Receiving Data Using an Interrupt Program

Z.BUFRCVS

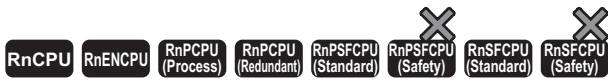

This instruction uses the interrupt program to receive communication data by using the nonprocedural or bidirectional protocol.

Ladder	ST
	ENO:=Z_BUFRCVS(EN,U,s,d);

FBD/LD

Execution condition

Instruction	Execution condition
Z.BUFRCVS	

Setting data

Description, range, data type

Operand	Description	Range	Data type	Data type (label)
(U)	Start I/O number (first three digits in four-digit hexadecimal representation) of a module	00H to FEH	String	ANY16_OR_STRING_SINGLE
(s)	Specifies the receive channel. • 1: Channel 1 (CH1 side) • 2: Channel 2 (CH2 side)	1, 2	16-bit unsigned binary	ANY16
(d)	Start device for storing the receive data (The receive data is read from the receive area in the buffer memory.)	—	Device name	ANY16 ^{*1}
EN	Execution condition	—	Bit	BOOL
ENO	Execution result	—	Bit	BOOL

*1 When specifying setting data by using a label, define an array to secure enough operation area and specify an element of the array label.

Applicable devices

Operand	Bit	Word			Double word			Indirect specification	Constant			Others (U)
	X, Y, M, L, SM, F, B, SB, FX, FY	J□□	T, ST, C, D, W, SD, SW, FD, R, ZR, RD	U□\G□, J□□, U3E□\(\H)G□	Z	LT, LST, LC	LZ		K, H	E	\$	
(U) ^{*1}	—	—	○	—	—	—	—	○	—	—	○	○
(s)	○ ^{*2}	—	○ ^{*3}	—	—	—	—	○	○	—	—	—
(d)	—	—	○ ^{*3}	—	—	—	—	○	—	—	—	—

*1 Index modification is not available.
*2 FX and FY cannot be used.
*3 FD cannot be used.

Receive data

Operand: (d)				
Device	Item	Description	Setting range	Set by
+0	Receive data length	Used to store the amount of data that was read from the data storage area for amount of receive data. ^{*1}	—	System
+1 to n	Receive data	Used to store the data, in ascending order of the address, that was read from the receive data storage area.	—	System

*1 The amount of the data to be received must be set in units as specified in the engineering tool. For byte specification, set the number of bytes. For word specification, set the number of words.

Processing details

- The data received from the external device is stored in the specified device.
- The receive data can be read without considering the address of the receive area of the buffer memory.
- When the Z.BUFRCVS instruction is executed, receive completion takes place; the receive read request signal (Xn3/XnA) or receive error detection signal (Xn4/XnB) turns off automatically. If the receive has been read using the Z.BUFRCVS instruction, the receive read completion signal (Yn1/Yn8) does not need to be turned on.
- The Z.BUFRCVS instruction is used in the interrupt program, and processing completes within one scan.
- The following figure shows the operation at the completion of the Z.BUFRCVS instruction.

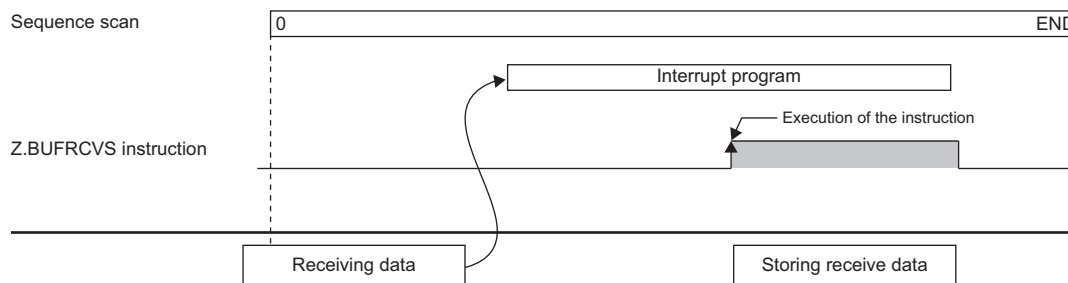

Precautions

- When data is to be received with the interrupt program, use the Z.BUFRCVS instruction.
- The following table summarizes the processes that take place if another instruction is issued while the Z.BUFRCVS instruction is active or the Z.BUFRCVS instruction is issued while another instruction is active with the same channel.

Instruction to execute concurrently*2	Possibility of concurrent execution	Handling for concurrent execution
G(P).OUTPUT	○	—
G(P).PRR		
G.INPUT	×	The G.INPUT and Z.BUFRCVS instructions cannot be used simultaneously. Concurrent execution is, however, possible if they use different channels.
G(P).BIDOUT	○	—
G(P).BIDIN	×	Concurrent execution of the G(P).BIDIN and Z.BUFRCVS instructions is not possible. Concurrent execution is, however, possible if they use different channels.
ZP.CSET	○	—
G(P).PUTE		
G(P).GETE		
Z.BUFRCVS		
G(P).SPBUSY		
ZP.UINI		

*2 The following instructions are not available with the same channel as for the Z.BUFRCVS instruction because they use a communication protocol different from the one used by this instruction.

- G(P).ONDEMAND and G(P).CPRTCL instructions
- For the receive data storage device for the Z.BUFRCVS instruction, secure in advance the area larger than the amount of data that will be received from the external device. If it has not been secured, the data located at the rear of the storage device will be overwritten.
- The local device and the file register for each program are not available for setting data.
- The read error codes issued during occurrence of a receive error can be read from the data receive result storage area (address: 258H/268H) of the buffer memory.

Operation error

Error code (SD0)	Description
4000H to 4FFFH	 MELSEC iQ-R CPU Module User's Manual (Application)

9.9 Sending Data by Using User Frames

G(P).PRR

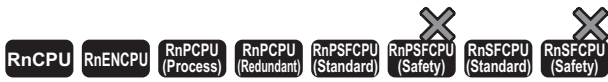

These instructions send data with user frames according to the specification in the user frame specification area for sending, through communication with the nonprocedural protocol.

Ladder	ST
	<pre>ENO:=G_PRR(EN,U,s,d); ENO:=GP_PRR(EN,U,s,d);</pre>

FBD/LD

Execution condition

Instruction	Execution condition
G.PRR	
GP.PRR	

Setting data

Description, range, data type

Operand	Description	Range	Data type	Data type (label)
(U)	Start I/O number (first three digits in four-digit hexadecimal representation) of a module	00H to FEH	16-bit unsigned binary	ANY16
(s)	Start device where control data is stored	Refer to the control data.	Device name	ANY16 ^{*1}
(d)	Device that turns on for one scan upon completion of the instruction When the instruction completes with an error, (d)+1 also turns on.	—	Bit	ANYBIT_ARRAY (Number of elements: 2)
EN	Execution condition	—	Bit	BOOL
ENO	Execution result	—	Bit	BOOL

*1 When specifying setting data by using a label, define an array to secure enough operation area and specify an element of the array label.

Applicable devices

Operand	Bit		Word		Double word			Indirect specification	Constant				Others (U)
	X, Y, M, L, SM, F, B, SB, FX, FY	J□\□	T, ST, C, D, W, SD, SW, FD, R, ZR, RD	U□\G□, J□\□, U3E□(H)G□	Z	LT, LST, LC	LZ		K	H	E	\$	
(U) ^{*1}	—	—	○ ^{*3}	—	—	—	○	○	—	—	○	—	
(s)	—	—	○ ^{*4}	—	—	—	○	—	—	—	—	—	
(d)	○ ^{*2}	—	○ ^{*4}	—	—	—	—	—	—	—	—	—	

*1 Index modification is not available.
 *2 FX and FY cannot be used.
 *3 RD cannot be used.
 *4 FD cannot be used.

Control data

Operand: (s)				
Device	Item	Description	Setting range	Set by
+0	Send channel	Specifies the send channel. • 1: Channel 1 (CH1 side) • 2: Channel 2 (CH2 side)	1, 2	User
+1	Result of sending	Used to store the result of sending with the G(P).PRR instruction. • 0: Normal • Other than 0: Error (error code)	—	System
+2	CR/LF append specification	Specifies whether to append CR or LF to send data.	0, 1	User
+3	Send pointer	Specifies the frame number that indicates the start position of send data within the user frame specification area for sending.	1 to 100	User
+4	Amount of output	Specifies the number of user frames to be sent.	1 to 100	User

Processing details

- By using the nonprocedural protocol of the module specified by (U), the data in the user frames is sent according to the control data stored in the device specified by (s) and later and the user frame specification area for sending of the module.
- The completion status of the G(P).PRR instruction can be checked with the completion device (d) and the completion status indication device (d)+1.

- Completion device (d)

This device turns on during END processing of the scan where the G(P).PRR instruction completes, and turns off during the next END processing.

- Completion status indication device (d)+1

This device turns on or off depending on the completion status of the G(P).PRR instruction.

When completed successfully: The device remains off.

When completed with an error: The device turns on during END processing of the scan where the G(P).PRR instruction completes, and turns off during the next END processing.

- The following figure shows the operation at the completion of the G(P).PRR instruction.

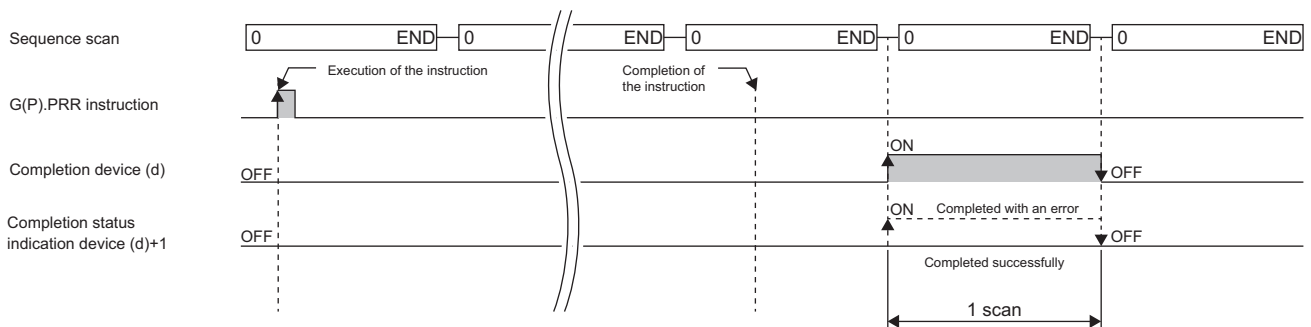

Precautions

- The following table summarizes the processes that take place if another instruction is issued while the G(P).PRR instruction is active or the G(P).PRR instruction is issued while another instruction is active with the same channel.

Instruction to execute concurrently ^{*1}	Possibility of concurrent execution	Handling for concurrent execution
G(P).PRR	×	The instruction is ignored and does not start processing until the active instruction completes. Concurrent execution is, however, possible if they use different channels.
G.INPUT	○	—
G(P).OUTPUT	×	A dedicated instruction concurrent execution error (7FF0H) occurs in the second instruction. Concurrent execution is, however, possible if they use different channels.
ZP.CSET		
G(P).PUTE	○	—
G(P).GETE		
Z.BUFRCVS		
G(P).SPBUSY		
ZP.UINI	×	A dedicated instruction concurrent execution error (7FF0H) occurs in the second instruction.

*1 The following instructions are not available with the same channel as for the G(P).PRR instruction because they use a communication protocol different from the one used by this instruction.

- G(P).ONDEMAND, G(P).CPRTCL, G(P).BIDOUT, and G(P).BIDIN instructions
- The local device and the file register for each program are not available for setting data.

Operation error

Error code ((s)+1)	Description
7000H to 7FFFH	 MELSEC iQ-R Serial Communication Module User's Manual (Application)

9.10 Clearing Receive Data

ZP.CSET

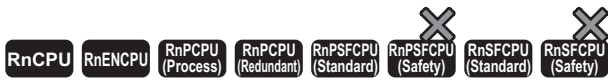

This instruction clears the receive data area without stopping send processing by using the nonprocedural protocol.

Ladder	ST
	<pre>ENO:=ZP_CSET(EN,U,s1,s2,d1,d2);</pre>

FBD/LD

Execution condition

Instruction	Execution condition
ZP.CSET	

Setting data

Description, range, data type

Operand	Description	Range	Data type	Data type (label)
(U)	Start I/O number (first three digits in four-digit hexadecimal representation) of a module	00H to FEH	String	ANY16_OR_STRING_SINGLE
(s1)	Channel number of the channel for which the receive data clear request is issued • 1: Channel (CH1 side) • 2: Channel (CH2 side)	1, 2	16-bit unsigned binary	ANY16
(s2)	Start device where control data is stored	Refer to the control data.	Device name	ANY16 ^{*1}
(d1)	Dummy	—	Device name	ANY16
(d2)	Device that turns on for one scan upon completion of the instruction When the instruction completes with an error, (d2)+1 also turns on.	—	Bit	ANYBIT_ARRAY (Number of elements: 2)
EN	Execution condition	—	Bit	BOOL
ENO	Execution result	—	Bit	BOOL

*1 When specifying setting data by using a label, define an array to secure enough operation area and specify an element of the array label.

■Applicable devices

Operand	Bit		Word				Double word		Indirect specification	Constant			Others (U)
	X, Y, M, L, SM, F, B, SB, FX, FY	J□□	T, ST, C, D, W, SD, SW, FD, R, ZR, RD	U□V□, J□□, U3E□(H)G□	Z	LT, LST, LC	LZ	K, H, E, \$					
(U)*1	—	—	○	—	—	—	—	○	—	—	○	○	
(s1)	○*2	—	○*3	—	—	—	—	○	○	—	—	—	
(s2)	—	—	○*3	—	—	—	—	○	—	—	—	—	
(d1)	—	—	○*3	—	—	—	—	○	—	—	—	—	
(d2)	○*2	—	○*3	—	—	—	—	—	—	—	—	—	

*1 Index modification is not available.

*2 FX and FY cannot be used.

*3 FD cannot be used.

■Control data

Operand: (s2)				
Device	Item	Description	Setting range	Set by
+0	Execution type	Specifies 0.	0	User
+1	Completion status	Used to store the completion status. • 0: Normal • Other than 0: Error (error code)	—	System
+2	Request type	Specifies the contents of request. • 4: Receive data clear request	4	User
+3 to +111	For system	Use prohibited (not available also for other applications such as programming)	—	System

Processing details

- This function only clears receive data from the OS area, but does not clear any data from the user receive area in the buffer memory.
- If the ZP.CSET instruction is issued when the receive read request (Xn3/XnA) or receive error detection (Xn4/XnB) is on, it has to wait until the signal turns off.
- The completion status of the ZP.CSET instruction can be checked with the completion device (d2) and the completion status indication device (d2)+1.

• Completion device (d2)

This device turns on during END processing of the scan where the ZP.CSET instruction completes, and turns off during the next END processing.

• Completion status indication device (d2)+1

This device turns on or off depending on the completion status of the ZP.CSET instruction.

When completed successfully: The device remains off.

When completed with an error: The device turns on during END processing of the scan where the ZP.CSET instruction completes, and turns off during the next END processing.

- The following figure shows the operation at the completion of the ZP.CSET instruction.

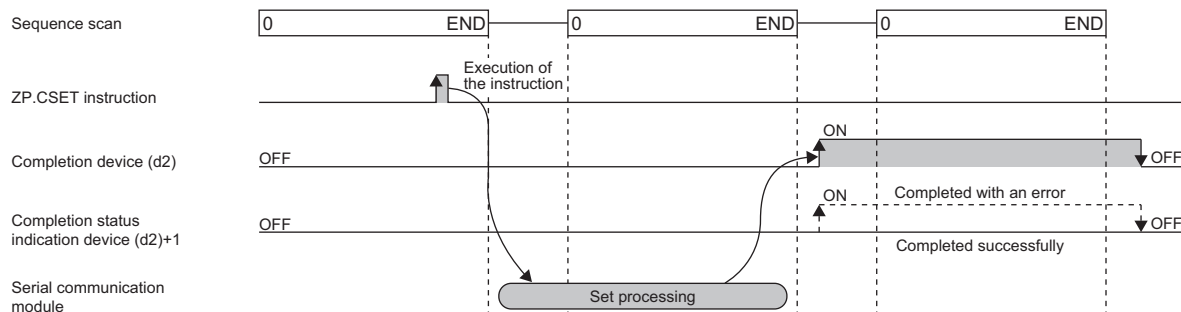

Precautions

- The following table summarizes the processes that take place if another instruction is issued while the ZP.CSET instruction is active or the ZP.CSET instruction is issued while another instruction is active with the same channel.

Instruction to execute concurrently ^{*1}	Possibility of concurrent execution	Handling for concurrent execution
G(P).ONDEMAND	×	A dedicated instruction concurrent execution error (7FF0H) occurs in the second instruction. Concurrent execution is, however, possible if they use different channels.
G(P).OUTPUT		
G(P).PRR		
G(P).BIDOUT		
G(P).BIDIN		
G.INPUT	See the right	<ul style="list-style-type: none"> If the G.INPUT and ZP.CSET instructions are issued in this order A dedicated instruction concurrent execution error (7FF0H) occurs in the ZP.CSET instruction. Concurrent execution is, however, possible if they use different channels. If the ZP.CSET and G.INPUT instructions are issued in this order Concurrent execution is possible.
ZP.CSET	×	The instruction is ignored and does not start processing until the active instruction completes. Concurrent execution is, however, possible if they use different channels.
G(P).PUTE	○	—
G(P).GETE		
Z.BUFRCVS		
G(P).SPBUSY		
ZP.UINI	×	A dedicated instruction concurrent execution error (7FF0H) occurs in the second instruction.

*1 The G(P).CPRTCL instruction is not available with the same channel as for the Z(P).CSET instruction because it uses a communication protocol different from the one used by the ZP.CSET instruction. If the above instruction is used with the same channel as for the G(P).CPRTCL instruction, a communication protocol setting error (7FF2H) will occur.

- The local device and the file register for each program are not available for setting data.

Operation error

Error code ((s2)+1)	Description
7000H to 7FFFH	 MELSEC iQ-R Serial Communication Module User's Manual (Application)

9.11 Registering/Canceling the Programmable Controller CPU Monitoring

ZP.CSET



This instruction performs programmable controller CPU monitoring registration to enable use of the programmable controller CPU monitoring function, or cancels it.

Ladder	ST
	<pre>ENO:=ZP_CSET(EN,U,s1,s2,d1,d2);</pre>

FBD/LD

Execution condition

Instruction	Execution condition
ZP.CSET	

Setting data

Description, range, data type

Operand	Description	Range	Data type	Data type (label)
(U)	Start I/O number (first three digits in four-digit hexadecimal representation) of a module	00H to FEH	String	ANY16_OR_STRING_SINGLE
(s1)	Channel number of the channel for which to send the monitoring result • 1: Channel (CH1 side) • 2: Channel (CH2 side)	1, 2	16-bit unsigned binary	ANY16
(s2)	Start device where control data is stored	Refer to the control data.	Device name	ANY16 ^{*1}
(d1)	Dummy	—	Device name	ANY16
(d2)	Device that turns on for one scan upon completion of the instruction When the instruction completes with an error, (d2)+1 also turns on.	—	Bit	ANYBIT_ARRAY (Number of elements: 2)
EN	Execution condition	—	Bit	BOOL
ENO	Execution result	—	Bit	BOOL

*1 When specifying setting data by using a label, define an array to secure enough operation area and specify an element of the array label.

■Applicable devices

Operand	Bit		Word			Double word		Indirect specification	Constant			Others (U)
	X, Y, M, L, SM, F, B, SB, FX, FY	J□□	T, ST, C, D, W, SD, SW, FD, R, ZR, RD	U□V□, J□□, U3E□(H)□	Z	LT, LST, LC	LZ		K, H	E	\$	
(U)*1	—	—	○	—	—	—	○	—	—	○	○	
(s1)	○*2	—	○*3	—	—	—	○	○	—	—	—	
(s2)	—	—	○*3	—	—	—	○	—	—	—	—	
(d1)	—	—	○*3	—	—	—	○	—	—	—	—	
(d2)	○*2	—	○*3	—	—	—	—	—	—	—	—	

*1 Index modification is not available.

*2 FX and FY cannot be used.

*3 FD cannot be used.

■Control data

- When programmable controller CPU monitoring is registered

Operand: (s2)					
Device	Item	Description	Setting range	Set by	
+0	Execution type	Specifies 0.	0	User	
+1	Completion status	Used to store the completion status. • 0: Normal • Other than 0: Error (error code)	—	System	
+2	Request type	Specifies the contents of request. • 2: Performs programmable controller CPU monitoring registration.	2	User	
+3	Unit of cycle time	Specifies the unit of the cycle time. • 0: 100ms • 1: Second • 2: Minute	0 to 2	User	
+4	Cycle time	Specifies the cycle time.	1H to FFFFH	User	
+5	Programmable controller CPU monitoring function	Specifies the monitoring function. • 1: Sending with a fixed cycle • 2: Sending upon condition matching	1, 2	User	
+6	Sending means for programmable controller CPU monitoring	Specifies the sending means. • 0: Sending data (device data, CPU error information)	0	User	
+7	Cyclic broadcast send	User frame output start pointer	Specifies the start pointer of the table where the user frame numbers for sending with a fixed cycle have been set. • 0: Not specified (sending upon condition matching) • 1 to 100: Amount of data sent	0, 1 to 100	User
+8		Number of user frames sent	Specifies the number of user frames that are sent, or output, with a fixed cycle. • 0: Not specified (sending upon condition matching) • 1 to 100: Amount of data sent	0, 1 to 100	User
+9	For system	Use prohibited	—	—	
+10	Number of reserved word blocks	Specifies the number of blocks of the word device to be monitored.	0 to 10	User	
+11	Number of registered bit blocks	Specifies the number of blocks of the bit device to be monitored.	0 to 10	User	
+12	Programmable controller CPU error monitoring (programmable controller CPU status monitoring)	Specifies whether to monitor programmable controller CPU errors. • 0: Not monitored • 1: Monitored	0, 1	User	
+13	Programmable controller CPU monitoring setting	Device code	Specifies the code of the device to be monitored. • 0: Not monitored • Other than 0: Monitored (code of the device to be monitored)	0 or more	User

Operand: (s2)							
Device	Item		Description	Setting range	Set by		
+14, +15	1st piece (1st block)	Start device monitored	Specifies the start device monitored of this block.	0 or more	User		
+16		Number of registered points	Specifies the number of registered, or read, points of this block. For a bit device, specify the number of points in units of words. • 0: Device not monitored • 1 or more: Number of registered points	0 or more	User		
+17		Sending upon condition matching	Monitoring condition	Specifies the monitoring condition for this block. • 0: Not specified (when sending with a fixed cycle) • 1 or more: Monitoring conditions	Refer to the following. 📖 MELSEC iQ-R Serial Communication Module User's Manual (Application)	User	
+18			Monitoring condition value	Specifies the monitoring condition value for this block. Specify 0 for sending with a fixed cycle. • 0 or more: Monitoring conditions		User	
+19			User frame output start pointer	Specifies the start pointer of the table where the user frame numbers for sending upon condition matching have been set. • 0: Not specified (when sending with a fixed cycle) • 1 to 100: Start pointer		0, 1 to 100	User
+20			Number of user frames sent	Specifies the number of user frames that are sent, or output, upon condition matching. • 0: Not specified (when sending with a fixed cycle) • 1 to 100: Amount of data sent		0, 1 to 100	User
+21	For system		Use prohibited	—	—		
+22 to +102	2nd to 10th piece of programmable controller CPU monitoring setting (2nd to 10th block)		Same row as 1st piece of programmable controller CPU monitoring setting	—	User		
+103	CPU status monitoring setting (error monitoring 11th piece) (11th block)	Sending upon condition matching	Fixed value	Specifies the fixed value if the CPU status is monitored.	1	User	
+104				0	User		
+105				0	User		
+106				1	User		
+107				5	User		
+108				1	User		
+109		User frame output start pointer	Specifies the start pointer of the table where the user frame numbers for sending upon condition matching have been set. • 0: Not specified (when sending with a fixed cycle) • 1 to 100: Start pointer	0, 1 to 100	User		
+110		Number of user frames sent	Specifies the number of user frames that are sent, or output, upon condition matching. • 0: Not specified (when sending with a fixed cycle) • 1 to 100: Amount of data sent	0, 1 to 100	User		
+111		For system		Use prohibited	—	—	

- When programmable controller CPU monitoring is canceled

Operand: (s2)					
Device	Item	Description	Setting range	Set by	
+0	Execution type	Specifies "0".	0	User	
+1	Completion status	Used to store the completion status. • 0: Normal • Other than 0: Error (error code)	—	System	
+2	Request type	Specifies the contents of request. • 3: Cancels programmable controller CPU monitoring.	3	User	
+3 to +111	For system		Use prohibited (not available also for other applications such as programming)	—	System

Processing details

- To perform programmable controller CPU monitoring registration, register the data that is used for the module to execute the CPU module function. Once the data used to execute the programmable controller CPU monitoring function has completed successfully, the module starts monitoring the programmable controller CPU and sending the send result to the external device.
- To cancel programmable controller CPU monitoring, stop the programmable controller CPU monitoring processing that is being executed by the module. Once programmable controller CPU monitoring has been canceled successfully, the module stops operation of the programmable controller CPU monitoring function.
- If device memory is monitored, a maximum of 10 blocks can be specified for the word and bit devices. To register the device memory to be monitored, specify the word device blocks corresponding to the number of registered word blocks before specifying the bit device blocks corresponding to the registered bit blocks.
- To send the CPU monitoring result to the external device, register the user frames and the user frame numbers using the engineering tool.
- To perform programmable controller CPU monitoring registration again, cancel programmable controller CPU monitoring before registration.
- The completion status of the ZP.CSET instruction can be checked with the completion device (d2) and the completion status indication device (d2)+1.

- Completion device (d2)

This device turns on during END processing of the scan where the ZP.CSET instruction completes, and turns off during the next END processing.

- Completion status indication device (d2)+1

This device turns on or off depending on the completion status of the ZP.CSET instruction.

When completed successfully: The device remains off.

When completed with an error: The device turns on during END processing of the scan where the ZP.CSET instruction completes, and turns off during the next END processing.

- If the programmable controller CPU monitoring registration is to be performed, the following data may be specified in the control data only if the communication protocol setting for the target interface is nonprocedural protocol.

- User frame output start pointer for sending with a fixed cycle/sending upon condition matching
- Number of user frames sent for sending with a fixed cycle/sending upon condition matching

When the communication setting for the target interface is MC protocol, specifying the user frame output start pointer or the number of user frames sent is not required. (They will be ignored if specified).

- The following figure shows the operation at the completion of the ZP.CSET instruction.

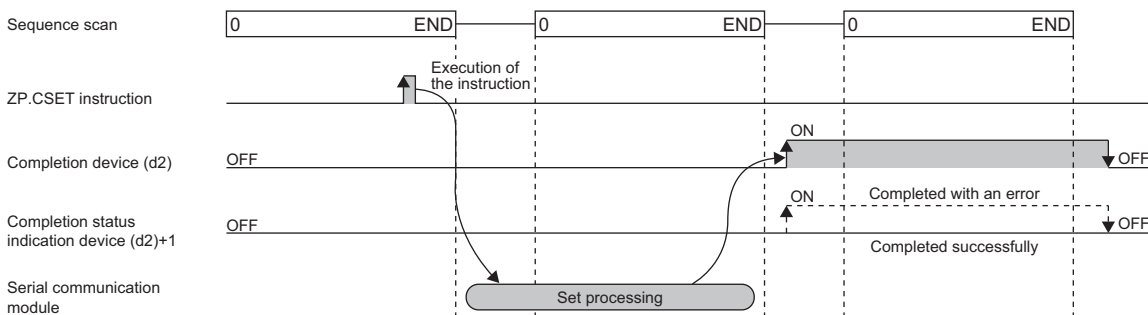

Precautions

- The following table summarizes the processes that take place if another instruction is issued while the ZP.CSET instruction is active or the ZP.CSET instruction is issued while another instruction is active with the same channel.

Instruction to execute concurrently*1	Possibility of concurrent execution	Handling for concurrent execution
G(P).ONDEMAND	×	A dedicated instruction concurrent execution error (7FF0H) occurs in the second instruction. Concurrent execution is, however, possible if they use different channels.
G(P).OUTPUT		
G(P).PRR		
G(P).BIDOUT		
G(P).BIDIN		
G.INPUT	See the right	<ul style="list-style-type: none"> If the G.INPUT and ZP.CSET instructions are issued in this order A dedicated instruction concurrent execution error (7FF0H) occurs in the ZP.CSET instruction. Concurrent execution is, however, possible if they use different channels. If the ZP.CSET and G.INPUT instructions are issued in this order Concurrent execution is possible.
ZP.CSET	×	The instruction is ignored and does not start processing until the active instruction completes. Concurrent execution is, however, possible if they use different channels.
G(P).PUTE	○	—
G(P).GETE		
Z.BUFRCVS		
G(P).SPBUSY		
ZP.UINI	×	A dedicated instruction concurrent execution error (7FF0H) occurs in the second instruction.

*1 The following instructions are not available with the same channel as for the ZP.CSET instruction because they use a communication protocol different from the one used by this instruction. In addition, if these are used with the same channel as for the ZP.CSET instruction, a communication protocol setting error (7FF2H) will occur.

- G(P).CPRTCL, G(P).BIDOUT, and G(P).BIDIN instructions
- The local device and the file register for each program are not available for setting data.

Operation error

Error code ((s2)+1)	Description
7000H to 7FFFH	 MELSEC iQ-R Serial Communication Module User's Manual (Application)

The programmable controller CPU monitoring settings (control data (s2)+13 to (s2)+102) are checked, not when the CSET instruction is executed, when the specified cycle time has elapsed.

If the CSET instruction is completed successfully and the registered monitoring data is not sent from the serial communication module within the specified cycle time, check the programmable controller CPU monitoring function execution results (buffer memory address: 2205H/2305H) to check for errors and troubleshoot.

9.12 Initial Setting

ZP.CSET

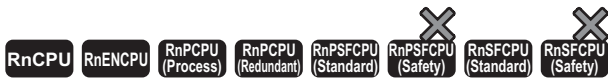

This instruction sets the unit (word or byte) of the amount of send/receive data and the data communication area.

Ladder	ST
	<pre>ENO:=ZP_CSET(EN,U,s1,s2,d1,d2);</pre>

FBD/LD

Execution condition

Instruction	Execution condition
ZP.CSET	

Setting data

Description, range, data type

Operand	Description	Range	Data type	Data type (label)
(U)	Start I/O number (first three digits in four-digit hexadecimal representation) of a module	00H to FEH	String	ANY16_OR_STRING_SINGLE
(s1)	Channel number of the channel for which the set value is changed. • 1: Channel (CH1 side) • 2: Channel (CH2 side)	1, 2	16-bit unsigned binary	ANY16
(s2)	Start device where control data is stored	Refer to the control data.	Device name	ANY16 ^{*1}
(d1)	Dummy	—	Device name	ANY16
(d2)	Device that turns on for one scan upon completion of the instruction When the instruction completes with an error, (d2)+1 also turns on.	—	Bit	ANYBIT_ARRAY (Number of elements: 2)
EN	Execution condition	—	Bit	BOOL
ENO	Execution result	—	Bit	BOOL

*1 When specifying setting data by using a label, define an array to secure enough operation area and specify an element of the array label.

■Applicable devices

Operand	Bit		Word				Double word		Indirect specification	Constant			Others (U)
	X, Y, M, L, SM, F, B, SB, FX, FY	J□□	T, ST, C, D, W, SD, SW, FD, R, ZR, RD	U□VG□, J□□□, U3E□(H)G□	Z	LT, LST, LC	LZ	K, H		E	\$		
(U)*1	—	—	○	—	—	—	—	○	—	—	○	○	
(s1)	○*2	—	○*3	—	—	—	—	○	○	—	—	—	
(s2)	—	—	○*3	—	—	—	—	○	—	—	—	—	
(d1)	—	—	○*3	—	—	—	—	○	—	—	—	—	
(d2)	○*2	—	○*3	—	—	—	—	—	—	—	—	—	

*1 Index modification is not available.

*2 FX and FY cannot be used.

*3 FD cannot be used.

■Control data

Operand: (s2)				
Device	Item	Description	Setting range	Set by
+0	Execution type	Specifies 0.	0	User
+1	Completion status	Used to store the completion status. • 0: Normal • Other than 0: Error (error code)	—	System
+2	Request type	Specifies the contents of request. • 1: Changes the unit of data (word or byte) and the buffer memory assignment.	1	User
+3	Word/byte specification	Specifies the unit of the amount of send/receive data. • 0: Current set value • 1: In units of words • 2: In units of bytes	0 to 2	User
+4	Buffer memory start address for on-demand function	Specifies the start address of the buffer memory area to be used for the on-demand function. • 0: The current set value is used. • 400H to 1AFFH, 2600H to 3FFFH: Start address	0H, 400H to 1AFFH, 2600H to 3FFFH	User
+5	Size of buffer memory for on-demand function	Specifies the size (words) of the buffer memory area to be used for the on-demand function. • 0: The current set value is used. • 1H to 1A00H: Size	0H, 1H to 1A00H	User
+6	Sending area start address	Specifies the start address of the sending area to be used for the nonprocedural or bidirectional protocol. • 0: The current set value is used. • 400H to 1AFFH, 2600H to 3FFFH: Start address	0H, 400H to 1AFFH, 2600H to 3FFFH	User
+7	Size of sending area	Specifies the size (words) of the sending area to be used for the nonprocedural or bidirectional protocol. The one word start area of the sending area is used for specifying the amount of send data. • 0: The current set value is used. • 1H to 1A00H: Size	0H, 1H to 1A00H	User
+8	Receiving area start address	Specifies the start address of the receiving area to be used for the nonprocedural or bidirectional protocol. • 0: The current set value is used. • 400H to 1AFFH, 2600H to 3FFFH: Start address	0H, 400H to 1AFFH, 2600H to 3FFFH	User
+9	Size of receiving area	Specifies the size (words) of the receiving area to be used for the nonprocedural or bidirectional protocol. The one word start area of the receiving area is used for specifying the amount of send data. • 0H: The current set value is used. • 1H to 1A00H: Size	0H, 1H to 1A00H	User
+10 to +111	For system	Use prohibited (not available also for other applications such as programming)	—	System

Processing details

- The following current set values are changed, which are used for data communication with each communication protocol.
 - Unit of the amount of the data to be sent or received (word or byte)
 - Sending area of the buffer memory to be used for the MC protocol on-demand function
 - Sending or receiving area of the buffer memory to be used for the nonprocedural protocol
 - Sending or receiving area of the buffer memory to be used for the bidirectional protocol
- To change any of the above set values from the CPU module, execute the ZP.CSET instruction. In addition, execute it one scan before the start of data communication or earlier. After the start of data communication, the ZP.CSET instruction cannot be executed, therefore, the set value cannot be changed. The system does not allow concurrent execution of two or more ZP.CSET instructions set to perform the initial setting.
- The completion status of the ZP.CSET instruction can be checked with the completion device (d2) and the completion status indication device (d2)+1.

- Completion device (d2)

This device turns on during END processing of the scan where the ZP.CSET instruction completes, and turns off during the next END processing.

- Completion status indication device (d2)+1

This device turns on or off depending on the completion status of the ZP.CSET instruction.

When completed successfully: The device remains off.

When completed with an error: The device turns on during END processing of the scan where the ZP.CSET instruction completes, and turns off during the next END processing.

- The following figure shows the operation at the completion of the ZP.CSET instruction.

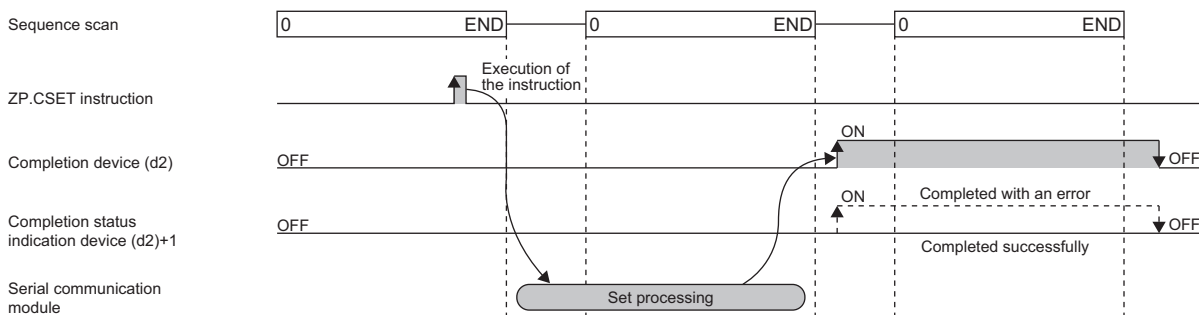

Precautions

- The following table summarizes the processes that take place if another instruction is issued while the ZP.CSET instruction is active or the ZP.CSET instruction is issued while another instruction is active with the same channel.

Instruction to execute concurrently*1	Possibility of concurrent execution	Handling for concurrent execution
G(P).ONDEMAND	×	A dedicated instruction concurrent execution error (7FF0H) occurs in the second instruction. Concurrent execution is, however, possible if they use different channels.
G(P).OUTPUT		
G(P).PRR		
G(P).BIDOUT		
G(P).BIDIN		
G.INPUT	See the right	<ul style="list-style-type: none"> If the G.INPUT and ZP.CSET instructions are issued in this order A dedicated instruction concurrent execution error (7FF0H) occurs in the ZP.CSET instruction. If the ZP.CSET and G.INPUT instructions are issued in this order Concurrent execution is possible.
ZP.CSET	×	The instruction is ignored and does not start processing until the active instruction completes. Concurrent execution is, however, possible if they use different channels.
G(P).PUTE	○	—
G(P).GETE		
Z.BUFRCVS		
G(P).SPBUSY		
ZP.UINI	×	A dedicated instruction concurrent execution error (7FF0H) occurs in the second instruction.

*1 The G(P).CPRTCL instruction is not available with the same channel as for the Z(P).CSET instruction because it uses a communication protocol different from the one used by the ZP.CSET instruction. If the above instruction is used with the same channel as for the G(P).CPRTCL instruction, a communication protocol setting error (7FF2H) will occur.

- The local device and the file register for each program are not available for setting data.

Operation error

Error code ((s2)+1)	Description
7000H to 7FFFH	 MELSEC iQ-R Serial Communication Module User's Manual (Application)

9.13 Registering User Frames

G(P).PUTE



These instructions register user frames.

Ladder	ST
	<pre>ENO:=G_PUT(EN,U,s1,s2,d); ENO:=GP_PUT(EN,U,s1,s2,d);</pre>

FBD/LD

Execution condition

Instruction	Execution condition
G.PUT	
GP.PUT	

Setting data

Description, range, data type

Operand	Description	Range	Data type	Data type (label)
(U)	Start I/O number (first three digits in four-digit hexadecimal representation) of a module	00H to FEH	16-bit unsigned binary	ANY16
(s1)	Start device where control data is stored	Refer to the control data.	Device name	ANY16 ^{*1}
(s2)	Start device for storing the registered data	—	Device name	ANY16 ^{*1}
(d)	Device that turns on for one scan upon completion of the instruction When the instruction completes with an error, (d)+1 also turns on.	—	Bit	ANYBIT_ARRAY (Number of elements: 2)
EN	Execution condition	—	Bit	BOOL
ENO	Execution result	—	Bit	BOOL

*1 When specifying setting data by using a label, define an array to secure enough operation area and specify an element of the array label.

■Applicable devices

Operand	Bit		Word			Double word		Indirect specification	Constant			Others (U)
	X, Y, M, L, SM, F, B, SB, FX, FY	J□□	T, ST, C, D, W, SD, SW, FD, R, ZR, RD	U□□□, J□□□, U3E□(H)□□	Z	LT, LST, LC	LZ		K, H	E	\$	
(U)*1	—	—	○*3	—	—	—	○	○	—	—	○	
(s1)	—	—	○*4	—	—	—	○	—	—	—	—	
(s2)	—	—	○*4	—	—	—	○	—	—	—	—	
(d)	○*2	—	○*5	—	—	—	—	—	—	—	—	

*1 Index modification is not available.

*2 FX and FY cannot be used.

*3 RD cannot be used.

*4 FD cannot be used.

*5 T, ST, C, and FD cannot be used.

■Control data

Operand: (s1)				
Device	Item	Description	Setting range	Set by
+0	Registration/delete specification	Specifies whether to register or delete the user frame specified by (s1)+2. • 1: Registered • 3: Deleted	1, 3	User
+1	Registration/delete result	Used to store the result of registration or deletion with the G(P).PUTE instruction. • 0: Normal • Other than 0: Error (error code)	—	System
+2	Frame number	Specifies the user frame number.	1000 to 1199	User
+3	Number of registered bytes	• 1 to 80: Number of bytes of the user frame to be registered To delete the user frame, specify a value from 1 to 80 as the dummy.	1 to 80	User

Processing details

- User frames are registered or deleted for the module specified by (U).
- If a user frame is registered
 - To register a user frame, specify 1 for the device of (s1)+0. The data in the device specified by (s2) and later will be registered according to the control data.
 - The registered data must be stored as follows in the device specified by (s2) and later. Each of the devices to store the registered data requires the data for the following number of points from the device specified by (s2): (amount of registered data)/2.

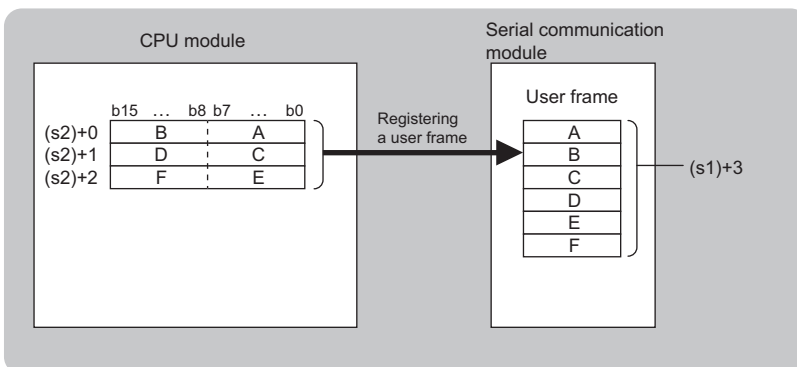

- If a user frame is deleted
 - To delete a user frame, specify "3" for the device of (s1)+0. The user frame with the frame number specified by (s1)+2 will be deleted.
 - Both the number of registered bytes specified by (s1)+3 and the registered data storage device specified by (s2) are required for the G(P).PUTE instruction format although they are not used by the G(P).PUTE instruction. Specify a value from 1 to 80 for (s1)+3. Specify a dummy device for (s2).
- The completion status of the G(P).PUTE instruction can be checked with the completion device (d) and the completion status indication device (d)+1.

• Completion device (d)

This device turns on during END processing of the scan where the G(P).PUTE instruction completes, and turns off during the next END processing.

• Completion status indication device (d)+1

This device turns on or off depending on the completion status of the G(P).PUTE instruction.

When completed successfully: The device remains off.

When completed with an error: The device turns on during END processing of the scan where the G(P).PUTE instruction completes, and turns off during the next END processing.

- The following figure shows the operation at the completion of the G(P).PUTE instruction.

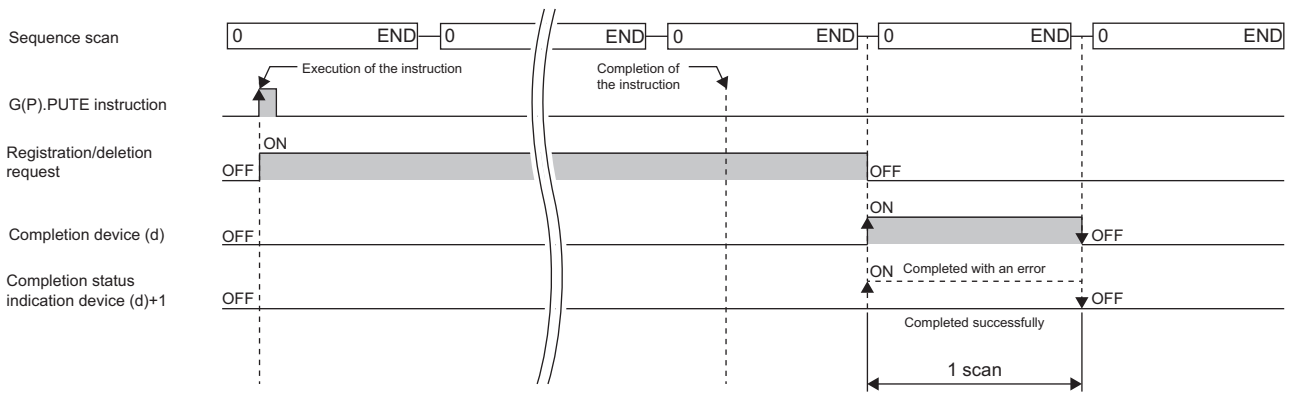

Precautions

- The following table summarizes the processes that take place if another instruction is issued while the G(P).PUTE instruction is active or the G(P).PUTE instruction is issued while another instruction is active with the same channel.

Instruction to execute concurrently	Possibility of concurrent execution	Handling for concurrent execution
G(P).ONDEMAND	○	—
G(P).OUTPUT		
G(P).PRR		
G(P).BIDOUT		
G(P).BIDIN		
G.INPUT		
ZP.CSET		
G(P).PUTE	×	A dedicated instruction concurrent execution error (7FF0H) occurs in the second instruction.
G(P).GETE	×	The instruction is ignored and does not start processing until the active instruction completes.
Z.BUFRCVS	○	—
G(P).SPBUSY		
ZP.UINI	×	A dedicated instruction concurrent execution error (7FF0H) occurs in the second instruction.
G(P).CPRTCL	○	—

Operation error

Error code ((s1)+1)	Description
7000H to 7FFFH	MELSEC iQ-R Serial Communication Module User's Manual (Application)

9.14 Reading User Frames

G(P).GETE

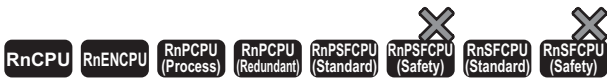

These instructions read user frames.

Ladder	ST
	<pre>ENO:=G_GETE(EN,U,s1,s2,d); ENO:=GP_GETE(EN,U,s1,s2,d);</pre>

FBD/LD

Execution condition

Instruction	Execution condition
G.GETE	
GP.GETE	

Setting data

Description, range, data type

Operand	Description	Range	Data type	Data type (label)
(U)	Start I/O number (first three digits in four-digit hexadecimal representation) of a module	00H to FEH	16-bit unsigned binary	ANY16
(s1)	Start device where control data is stored	Refer to the control data.	Device name	ANY16 ^{*1}
(s2)	Start device for storing the registered data that has been read.	—	Device name	ANY16 ^{*1}
(d)	Device that turns on for one scan upon completion of the instruction When the instruction completes with an error, (d)+1 also turns on.	—	Bit	ANYBIT_ARRAY (Number of elements: 2)
EN	Execution condition	—	Bit	BOOL
ENO	Execution result	—	Bit	BOOL

*1 When specifying setting data by using a label, define an array to secure enough operation area and specify an element of the array label.

■Applicable devices

Operand	Bit		Word			Double word		Indirect specification	Constant			Others (U)
	X, Y, M, L, SM, F, B, SB, FX, FY	J□□	T, ST, C, D, W, SD, SW, FD, R, ZR, RD	U□\G□, J□□, U3E□(H)G□	Z	LT, LST, LC	LZ		K, H	E	\$	
(U)*1	—	—	○*3	—	—	—	○	○	—	—	○	
(s1)	—	—	○*4	—	—	—	○	—	—	—	—	
(s2)	—	—	○*4	—	—	—	○	—	—	—	—	
(d)	○*2	—	○*5	—	—	—	—	—	—	—	—	

*1 Index modification is not available.

*2 FX and FY cannot be used.

*3 RD cannot be used.

*4 FD cannot be used.

*5 T, ST, C, and FD cannot be used.

■Control data

Operand: (s1)				
Device	Item	Description	Setting range	Set by
+0	Dummy	—	0	—
+1	Result of reading	Used to store the result of sending with the G(P).GETE instruction. • 0: Normal • Other than 0: Error (error code)	—	System
+2	Specified frame number	Specifies the user-registered number.	1000 to 1199	User
+3	Allowable number of bytes	Specifies the number of bytes storable in (s2), of the registered data of the read user frame.	1 to 80	User
	Number of registered bytes	Used to store the number of bytes of the registered data of the read user frame. • 1 to 80: Number of bytes of registered data	—	System

Processing details

- The data of the user frame is read from the module specified by (U).

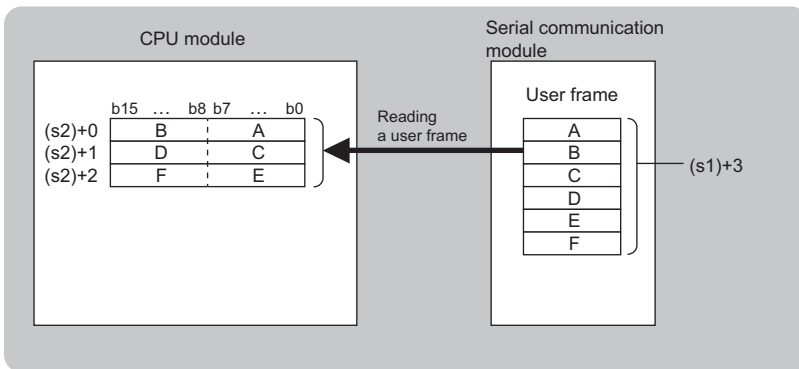

- The completion status of the G(P).GETE instruction can be checked with the completion device (d) and the completion status indication device (d)+1.

- Completion device (d)

This device turns on during END processing of the scan where the G(P).GETE instruction completes, and turns off during the next END processing.

- Completion status indication device (d)+1

This device turns on or off depending on the completion status of the G(P).GETE instruction.

When completed successfully: The device remains off.

When completed with an error: The device turns on during END processing of the scan where the G(P).GETE instruction completes, and turns off during the next END processing.

- The following figure shows the operation at the completion of the G(P).GETE instruction.

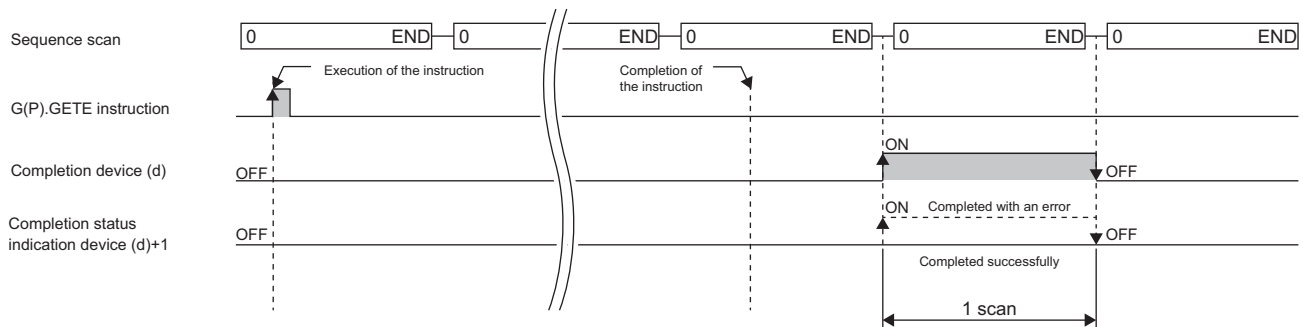

Precautions

- The following table summarizes the processes that take place if another instruction is issued while the G(P).GETE instruction is active or the G(P).GETE instruction is issued while another instruction is active with the same channel.

Instruction to execute concurrently	Possibility of concurrent execution	Handling for concurrent execution
G(P).ONDEMAND	○	—
G(P).OUTPUT		
G(P).PRR		
G(P).BIDOUT		
G(P).BIDIN		
G.INPUT		
ZP.CSET		
G(P).PUTE	×	A dedicated instruction concurrent execution error (7FF0H) occurs in the second instruction.
G(P).GETE	×	The instruction is ignored and does not start processing until the active instruction completes.
Z.BUFRCVS	○	—
G(P).SPBUSY		
ZP.UINI	×	A dedicated instruction concurrent execution error (7FF0H) occurs in the second instruction.
G(P).CPRTCL	○	—

Operation error

Error code ((s1)+1)	Description
7000H to 7FFFH	 MELSEC IQ-R Serial Communication Module User's Manual (Application)

9.15 Switching the Mode

ZP.UINI

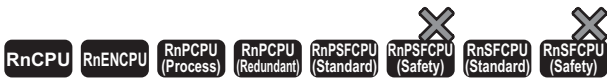

This instruction changes the communication protocol, transmission setting, or station number.

Ladder	ST
	<pre>ENO:=ZP_UINI(EN,U,s,d);</pre>

FBD/LD

Execution condition

Instruction	Execution condition
ZP.UINI	

Setting data

Description, range, data type

Operand	Description	Range	Data type	Data type (label)
(U)	Start I/O number (first three digits in four-digit hexadecimal representation) of a module	00H to FEH	String	ANY16_OR_STRING_SINGLE
(s)	Start device where control data is stored	Refer to the control data.	Device name	ANY16 ^{*1}
(d)	Device that turns on for one scan upon completion of the instruction When the instruction completes with an error, (d)+1 also turns on.	—	Bit	ANYBIT_ARRAY (Number of elements: 2)
EN	Execution condition	—	Bit	BOOL
ENO	Execution result	—	Bit	BOOL

*1 When specifying setting data by using a label, define an array to secure enough operation area and specify an element of the array label.

Applicable devices

Operand	Bit		Word		Double word		Indirect specification	Constant			Others (U)
	X, Y, M, L, SM, F, B, SB, FX, FY	J□□	T, ST, C, D, W, SD, SW, FD, R, ZR, RD	U□\G□, J□□□, U3E□\(\H)G□	Z	LT, LST, LC		LZ	K, H	E	
(U) ^{*1}	—	—	○	—	—	—	○	—	—	○	○
(s)	—	—	○ ^{*3}	—	—	—	○	—	—	—	—
(d)	○ ^{*2}	—	○ ^{*4}	—	—	—	—	—	—	—	—

*1 Index modification is not available.
 *2 FX and FY cannot be used.
 *3 FD cannot be used.
 *4 T, ST, C, and FD cannot be used.

■ Control data

Operand: (s)				
Device	Item	Description	Setting range	Set by
+0	For system	Always specifies 0.	0	User
+1	Execution result	Used to store the result of sending with the ZP.UINI instruction. • 0: Normal • Other than 0: Error (error code)	—	System
+2	Execution type	Specify the execution type. • 0: Change the settings according to the setting details indicated by (s)+3 and later. • 1: Restores the setting details of the user parameters that have been set in the engineering tool.	0, 1	User
+3	CH1 transmission specifications setting	Sets the CH1 side transmission setting. Check the current value of the buffer memory area (595 (253H)) to make the settings identical.	0 to 4095 (0000H to 0FFFH)	User
+4	CH1 communication protocol setting	Sets the CH1 side communication protocol. Check the current value of the buffer memory area (594(252H)) to make the settings identical.	0 to 9	User
+5	CH2 transmission specifications setting	Sets the CH2 side transmission setting. Check the current value of the buffer memory area (611(263H)) to make the settings identical.	0 to 4095 (0000H to 0FFFH)	User
+6	CH2 communication protocol setting	Sets the CH2 side communication protocol. Check the current value of the buffer memory area (610(262H)) to make the settings identical.	0 to 9	User
+7	Station number setting	Sets the station number.	0 to 31	User
+8 to +12	For system	Always specifies 0.	0	User

Processing details

- This instruction changes the communication protocol, transmission setting, or station number of each channel of the module specified by (U).
- The completion status of the ZP.UINI instruction can be checked with the completion device (d) and the completion status indication device (d)+1.

- Completion device (d)

This device turns on during END processing of the scan where the ZP.UINI instruction completes, and turns off during the next END processing.

- Completion status indication device (d)+1

This device turns on or off depending on the completion status of the ZP.UINI instruction.

When completed successfully: The device remains off.

When completed with an error: The device turns on during END processing of the scan where the ZP.UINI instruction completes, and turns off during the next END processing.

- The following figure shows the operation at the completion of the ZP.UINI instruction.

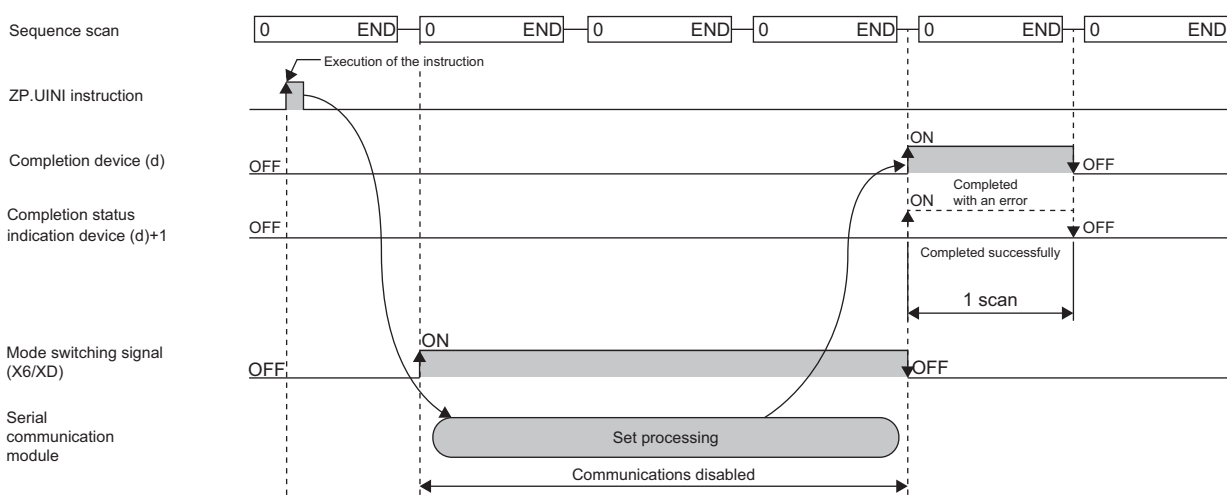

Precautions

- Stop the whole data communication with the external device before issuing the ZP.UINI instruction. If the ZP.UINI instruction is issued while data communication is in progress with the external device, the following will occur.
 - If the ZP.UINI instruction is issued during receiving
Receiving is interrupted, and the whole receive data stored so far is discarded.
 - If the ZP.UINI instruction is issued during sending
When the ZP.UINI instruction is accepted, sending is interrupted.

- If connection is provided through a modem, cut off the line to the external device before issuing the ZP.UINI instruction. If the ZP.UINI instruction is issued, the line will be cut off.
- If the communication protocol or transmission setting has been changed using the ZP.UINI instruction, the communication protocol and transmission settings of the external device side must be matched with the new settings. In addition, if the station number setting, or own station number, has been changed, the station number in the request message of the external device must be modified to the new station number.
- The following table summarizes the processes that take place if another instruction is issued while the ZP.UINI instruction is active or the ZP.UINI instruction is issued while another instruction is active with the same channel.

Instruction to execute concurrently	Possibility of concurrent execution	Handling for concurrent execution
G(P).ONDEMAND	×	A dedicated instruction concurrent execution error (7FF0H) occurs in the second instruction.
G(P).OUTPUT		
G(P).PRR		
G(P).BIDOUT		
G(P).BIDIN		
G.INPUT		
ZP.CSET		
G(P).PUTE		
G(P).GETE		
G(P).CPRTCL		
Z.BUFRCVS		
G(P).SPBUSY	○	—
ZP.UINI	×	The instruction is ignored and does not start processing until the active instruction completes.

- Before the ZP.UINI instruction is executed, the setting change in the transmission settings must be kept set to "Permitted" by using the parameter setting of the module. In addition, if the parameter is not yet set, the setting change in the transmission settings will be assumed to be "Permitted" during operation.
- Simultaneous use of mode change with the ZP.UINI instruction and that with the mode change request signal (Yn2/Yn9) must not be attempted. If it is attempted, an error will occur at an error code of 7FF5H.
- To use the current value of the communication protocol, transmission specifications, or station number as it is, acquire the value from each of the status storage areas in buffer memory before setting it in the control data.

Address (decimal (hexadecimal))		Application
CH1	CH2	
591(24FH)		Station number (instruction setting)
594(252H)	610(262H)	Communication protocol status
595(253H)	611(263H)	Transmission status

- When the communication protocol is set to "MODBUS Slave (RTU)" or "MODBUS Slave (ASCII)" before/after changing the protocol, the protocol cannot be changed using the ZP.UINI instruction.

Operation error

Error code ((s)+1)	Description
7000H to 7FFFH	 MELSEC iQ-R Serial Communication Module User's Manual (Application)

10 A/D CONVERSION INSTRUCTIONS

Point

- This chapter describes the instructions used commonly by MELSEC iQ-R series modules. When using MELSEC-Q series modules, refer to the manual for each module used and create programs. For precautions when using modules, refer to the MELSEC iQ-R Module Configuration Manual.
- When using the high speed analog-digital converter module, replace "normal mode" with "normal mode (medium speed: 10μs/CH)" or "normal mode (low speed: 20μs/CH)" to read and understand descriptions in this chapter.

10.1 Switching the Mode

G(P).OFFGAN



These instructions switch the analog module mode.

Ladder	ST
	<pre>ENO:=G_OFFGAN(EN,U,s); ENO:=GP_OFFGAN(EN,U,s);</pre>

FBD/LD

■ Execution condition

Instruction	Execution condition
G.OFFGAN	
GP.OFFGAN	

Setting data

■ Description, range, data type

Operand	Description	Range	Data type	Data type (label)
(U)	Start I/O number (first three digits in four-digit hexadecimal representation) of a module	00H to FEH	<ul style="list-style-type: none"> • 16-bit unsigned binary • 16-bit signed binary 	ANY16
(s)	Switching the mode <ul style="list-style-type: none"> • 0: Shift to normal mode (normal output mode)*1 • 1: Shift to offset/gain setting mode Setting a value outside the above range results in "Shift to offset/gain setting mode".	0, 1	<ul style="list-style-type: none"> • 16-bit unsigned binary • 16-bit signed binary 	ANY16
EN	Execution condition	—	Bit	BOOL
ENO	Execution result	—	Bit	BOOL

*1 The mode name differs depending on the module used: normal output mode for the R60DA4, R60DAV8, R60DAI8, and R60DAH4 and normal mode for other analog modules.

■Applicable devices

Operand	Bit		Word				Double word		Indirect specification	Constant			Others (U)
	X, Y, M, L, SM, F, B, SB, FX, FY	J□□	T, ST, C, D, W, SD, SW, FD, R, ZR, RD	U□\G□, J□□, U3E□(H)G□	Z	LT, LST, LC	LZ	K, H, E, \$					
(U)	—	—	○	—	—	—	—	○	○	—	—	○	
(s)	—	—	○*1	—	—	—	—	○	—	—	—	—	

*1 FD cannot be used.

Processing details

These instructions switch the mode of an analog module.

- Normal mode (Normal output mode) → Offset/gain setting mode (The offset/gain setting mode status flag (XA) turns on.)
- Offset/gain setting mode → Normal mode (Normal output mode) (The offset/gain setting mode status flag (XA) turns off.)

Point

- When the mode shifts from normal or normal output to offset/gain setting, Module READY (X0) changes on to off.
- When the mode shifts from offset/gain setting to normal or normal output, Module READY (X0) changes off to on. If a program exists that performs initial setting with Module READY (X0) on, note that initial setting processing will be executed.
- When the mode shifts from offset/gain setting to normal on the A/D converter module and temperature input module, it automatically resumes the operation with the previous operating conditions.
- When the D/A converter module shifts from the offset/gain setting mode to the normal mode (normal output mode), all channels enter in the D/A conversion disabled state. To resume D/A conversion, set "0" (D/A conversion enabled) in "CH□D/A conversion enabled/disabled setting" of the appropriate channel before turning on and off Operating condition setting request (Y9).

■Program example

The following figure shows an example of a program which uses the G(P).OFFGAN instruction with the R60AD4.

- Program content

Description			
When "Mode Shift Request" (M10) is turned on, the A/D converter module mounted at the position of I/O numbers X/Y10 to X/Y1F shifts to the offset/gain setting mode.			
When "Mode Shift Request" (M10) is turned off, the module returns to the normal mode.			
• Label setting			
Classification	Label name	Description	Device
Module label	R60AD_1.bOffsetGainSettingModeFlag	Offset/gain setting mode status flag	X1A
Label to be defined	Define the global label as shown below.		
	Label Name	Data Type	Class Assign (Device/Label)
	G_bModeShiftRequest	Bit	VAR_GLOBAL M10
	G_bOffsetGainModeFlag	Bit	VAR_GLOBAL M20
	G_bNormalModeFlag	Bit	VAR_GLOBAL M30
	G_uModeShiftKind	Word (Unsigned)/Bit String (16-bit)	VAR_GLOBAL D1

• Program example

(16)	G_bModeShiftRequest M10 ┆┆┆	MOV P	K1	G_uModeShiftKind D1
		G.OFF GAN	U1	G_uModeShiftKind D1
(77)	R60AD_1.bOffsetGainSettingModeFlag X1A ┆┆	SET		G_bOffsetGainModeFlag M20
(111)	G_bModeShiftRequest M10 ┆┆┆	MOV P	K0	G_uModeShiftKind D1
		G.OFF GAN	U1	G_uModeShiftKind D1
(172)	R60AD_1.bOffsetGainSettingModeFlag X1A ┆┆	SET		G_bNormalModeFlag M30
(187)				←END←

(16) Shifts to offset/gain setting mode.

(77) Describes the offset/gain setting processing.

(111) Shifts to normal mode.

(172) Describes the normal mode processing.

Precautions

In the following cases, the G(P).OFFGAN instruction will be disabled.

- The module has been set as a target of synchronization.
- The normal mode (high speed: 1μs/CH) or simultaneous conversion mode has been selected on the high speed analog-digital converter module.
- The wave output mode has been selected on the D/A converter module.
- The high-speed output mode has been selected on the high speed digital-analog converter module.

Operation error

There is no operation error.

10.2 Reading the User Range Setting Values

G(P).OGLOAD

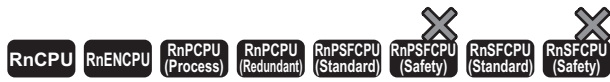

These instructions read the offset/gain setting values of the user range settings of an analog module into the CPU module.

Ladder	ST
	<pre>ENO:=G_OGLOAD(EN,U,s,d); ENO:=GP_OGLOAD(EN,U,s,d);</pre>

FBD/LD

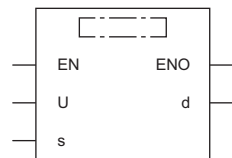

Execution condition

Instruction	Execution condition
G.OGLOAD	
GP.OGLOAD	

Setting data

Description, range, data type

Operand	Description	Range	Data type	Data type (label)
(U)	Start I/O number (first three digits in four-digit hexadecimal representation) of a module	00H to FEH	• 16-bit unsigned binary • 16-bit signed binary	ANY16
(s)	Start device where the control data is stored	Predefined devices	Device name	ANY16 ^{*1}
(d)	Device to be turned on for one scan when instruction processing completes. If the instruction is completed with an error, (d)+1 is also turned on.	Predefined devices	Bit	ANYBIT_ARRAY ^{*2} (Number of elements: 2)
EN	Execution condition	—	Bit	BOOL
ENO	Execution result	—	Bit	BOOL

*1 When specifying setting data by using a label, define an array to secure enough operation area and specify an element of the array label.

*2 When specifying setting data by using a label, use an array with two or more elements.

Applicable devices

Operand	Bit		Word			Double word		Indirect specification	Constant			Others (U)
	X, Y, M, L, SM, F, B, SB, FX, FY	J□□□	T, ST, C, D, W, SD, SW, FD, R, ZR, RD	U□□□, J□□□, U3E□□(H)G□	Z	LT, LST, LC	LZ		K, H	E	\$	
(U)	—	—	○	—	—	—	○	○	—	—	○	
(s)	—	—	○ ^{*1}	—	—	—	○	—	—	—	—	
(d)	○ ^{*2}	—	○ ^{*3}	—	—	—	○	—	—	—	—	

*1 FD cannot be used.

*2 FX and FY cannot be used.

*3 T, ST, C, and FD cannot be used.

■Control data

- For R60AD4, R60ADH4

Set only the save data type setting (s)+2. A data write to an area to be set by the system does not result in a normal read of the offset/gain setting values.

Operand: (s)				
Device	Item	Description	Setting range	Set by
+0	System area	—	—	—
+1	Completion status	The instruction completion status is stored. • 0: Completed successfully • Other than 0: Completed with an error (error code)	—	System
+2	Save data type setting	Specifies which one of the voltage and current is read as the offset/gain setting value. • 0: Voltage specification • 1: Current specification <div style="display: flex; align-items: center; border: 1px solid black; padding: 2px;"> b15 ... b3 b2 b1 b0 </div> <div style="display: flex; align-items: center; border: 1px solid black; padding: 2px; margin-top: 2px;"> 0 CH4 CH3 CH2 CH1 </div>	0000H to 000FH	User
+3	System area	—	—	—
+4	CH1 Factory default setting offset value (L)	—	—	System
+5	CH1 Factory default setting offset value (H)	—	—	System
+6	CH1 Factory default setting gain value (L)	—	—	System
+7	CH1 Factory default setting gain value (H)	—	—	System
+8	CH2 Factory default setting offset value (L)	—	—	System
+9	CH2 Factory default setting offset value (H)	—	—	System
+10	CH2 Factory default setting gain value (L)	—	—	System
+11	CH2 Factory default setting gain value (H)	—	—	System
+12	CH3 Factory default setting offset value (L)	—	—	System
+13	CH3 Factory default setting offset value (H)	—	—	System
+14	CH3 Factory default setting gain value (L)	—	—	System
+15	CH3 Factory default setting gain value (H)	—	—	System
+16	CH4 Factory default setting offset value (L)	—	—	System
+17	CH4 Factory default setting offset value (H)	—	—	System
+18	CH4 Factory default setting gain value (L)	—	—	System
+19	CH4 Factory default setting gain value (H)	—	—	System
+20	CH1 User range setting offset value (L)	—	—	System
+21	CH1 User range setting offset value (H)	—	—	System
+22	CH1 User range setting gain value (L)	—	—	System
+23	CH1 User range setting gain value (H)	—	—	System
+24	CH2 User range setting offset value (L)	—	—	System
+25	CH2 User range setting offset value (H)	—	—	System
+26	CH2 User range setting gain value (L)	—	—	System
+27	CH2 User range setting gain value (H)	—	—	System
+28	CH3 User range setting offset value (L)	—	—	System
+29	CH3 User range setting offset value (H)	—	—	System
+30	CH3 User range setting gain value (L)	—	—	System
+31	CH3 User range setting gain value (H)	—	—	System
+32	CH4 User range setting offset value (L)	—	—	System
+33	CH4 User range setting offset value (H)	—	—	System
+34	CH4 User range setting gain value (L)	—	—	System
+35	CH4 User range setting gain value (H)	—	—	System

- For R60DA4, R60DAH4

Set only the save data type setting (s)+2. A data write to an area to be set by the system does not result in a normal read of the offset/gain setting values.

Operand: (s)				
Device	Item	Description	Setting range	Set by
+0	System area	—	—	—
+1	Completion status	The instruction completion status is stored. • 0: Completed successfully • Other than 0: Completed with an error (error code)	—	System
+2	Save data type setting	Specify the user range setting for reading offset/gain setting values. • 0: User range setting (voltage specification) • 1: User range setting (current specification) <div style="border: 1px solid black; padding: 2px; width: fit-content; margin: 5px auto;"> b15 ... b3 b2 b1 b0 <div style="display: flex; justify-content: space-between; width: 100%;"> 0 CH4 CH3 CH2 CH1 </div> </div>	0000H to 000FH	User
+3	System area	—	—	—
+4	CH1 Factory default setting offset value	—	—	System
+5	CH1 Factory default setting gain value	—	—	System
+6	CH2 Factory default setting offset value	—	—	System
+7	CH2 Factory default setting gain value	—	—	System
+8	CH3 Factory default setting offset value	—	—	System
+9	CH3 Factory default setting gain value	—	—	System
+10	CH4 Factory default setting offset value	—	—	System
+11	CH4 Factory default setting gain value	—	—	System
+12	CH1 User range setting offset value	—	—	System
+13	CH1 User range setting gain value	—	—	System
+14	CH2 User range setting offset value	—	—	System
+15	CH2 User range setting gain value	—	—	System
+16	CH3 User range setting offset value	—	—	System
+17	CH3 User range setting gain value	—	—	System
+18	CH4 User range setting offset value	—	—	System
+19	CH4 User range setting gain value	—	—	System

• For R60ADV8, R60ADI8, R60AD8-G

Operand: (s)																								
Device	Item	Description	Setting range	Set by																				
+0	System area	—	—	—																				
+1	Completion status	The instruction completion status is stored. • 0: Completed successfully • Other than 0: Completed with an error (error code)	—	System																				
+2	Save data type setting* ¹	Specifies which one of the voltage and current is read as the offset/gain setting value. • 0: Voltage specification • 1: Current specification <div style="border: 1px solid black; padding: 2px; width: fit-content;"> <table style="width: 100%; border-collapse: collapse;"> <tr> <td style="text-align: right;">b15</td> <td style="text-align: center;">...</td> <td style="text-align: left;">b7</td> <td style="text-align: left;">b6</td> <td style="text-align: left;">b5</td> <td style="text-align: left;">b4</td> <td style="text-align: left;">b3</td> <td style="text-align: left;">b2</td> <td style="text-align: left;">b1</td> <td style="text-align: left;">b0</td> </tr> <tr> <td style="border: 1px solid black; width: 100px;">0</td> <td style="border: 1px solid black; width: 10px;"></td> <td style="border: 1px solid black; width: 10px;">CH8</td> <td style="border: 1px solid black; width: 10px;">CH7</td> <td style="border: 1px solid black; width: 10px;">CH6</td> <td style="border: 1px solid black; width: 10px;">CH5</td> <td style="border: 1px solid black; width: 10px;">CH4</td> <td style="border: 1px solid black; width: 10px;">CH3</td> <td style="border: 1px solid black; width: 10px;">CH2</td> <td style="border: 1px solid black; width: 10px;">CH1</td> </tr> </table> </div>	b15	...	b7	b6	b5	b4	b3	b2	b1	b0	0		CH8	CH7	CH6	CH5	CH4	CH3	CH2	CH1	0000H to 00FFH	User
b15	...	b7	b6	b5	b4	b3	b2	b1	b0															
0		CH8	CH7	CH6	CH5	CH4	CH3	CH2	CH1															
+3	System area	—	—	—																				
+4	CH1 Factory default setting offset value (L)	—	—	System																				
+5	CH1 Factory default setting offset value (H)	—	—	System																				
+6	CH1 Factory default setting gain value (L)	—	—	System																				
+7	CH1 Factory default setting gain value (H)	—	—	System																				
+8	CH2 Factory default setting offset value (L)	—	—	System																				
+9	CH2 Factory default setting offset value (H)	—	—	System																				
+10	CH2 Factory default setting gain value (L)	—	—	System																				
+11	CH2 Factory default setting gain value (H)	—	—	System																				
+12	CH3 Factory default setting offset value (L)	—	—	System																				
+13	CH3 Factory default setting offset value (H)	—	—	System																				
+14	CH3 Factory default setting gain value (L)	—	—	System																				
+15	CH3 Factory default setting gain value (H)	—	—	System																				
+16	CH4 Factory default setting offset value (L)	—	—	System																				
+17	CH4 Factory default setting offset value (H)	—	—	System																				
+18	CH4 Factory default setting gain value (L)	—	—	System																				
+19	CH4 Factory default setting gain value (H)	—	—	System																				
+20	CH5 Factory default setting offset value (L)	—	—	System																				
+21	CH5 Factory default setting offset value (H)	—	—	System																				
+22	CH5 Factory default setting gain value (L)	—	—	System																				
+23	CH5 Factory default setting gain value (H)	—	—	System																				
+24	CH6 Factory default setting offset value (L)	—	—	System																				
+25	CH6 Factory default setting offset value (H)	—	—	System																				
+26	CH6 Factory default setting gain value (L)	—	—	System																				
+27	CH6 Factory default setting gain value (H)	—	—	System																				
+28	CH7 Factory default setting offset value (L)	—	—	System																				
+29	CH7 Factory default setting offset value (H)	—	—	System																				
+30	CH7 Factory default setting gain value (L)	—	—	System																				
+31	CH7 Factory default setting gain value (H)	—	—	System																				
+32	CH8 Factory default setting offset value (L)	—	—	System																				
+33	CH8 Factory default setting offset value (H)	—	—	System																				
+34	CH8 Factory default setting gain value (L)	—	—	System																				
+35	CH8 Factory default setting gain value (H)	—	—	System																				
+36	CH1 User range setting offset value (L)	—	—	System																				
+37	CH1 User range setting offset value (H)	—	—	System																				
+38	CH1 User range setting gain value (L)	—	—	System																				
+39	CH1 User range setting gain value (H)	—	—	System																				
+40	CH2 User range setting offset value (L)	—	—	System																				
+41	CH2 User range setting offset value (H)	—	—	System																				
+42	CH2 User range setting gain value (L)	—	—	System																				
+43	CH2 User range setting gain value (H)	—	—	System																				
+44	CH3 User range setting offset value (L)	—	—	System																				

Operand: (s)				
Device	Item	Description	Setting range	Set by
+45	CH3	User range setting offset value (H)	—	System
+46	CH3	User range setting gain value (L)	—	System
+47	CH3	User range setting gain value (H)	—	System
+48	CH4	User range setting offset value (L)	—	System
+49	CH4	User range setting offset value (H)	—	System
+50	CH4	User range setting gain value (L)	—	System
+51	CH4	User range setting gain value (H)	—	System
+52	CH5	User range setting offset value (L)	—	System
+53	CH5	User range setting offset value (H)	—	System
+54	CH5	User range setting gain value (L)	—	System
+55	CH5	User range setting gain value (H)	—	System
+56	CH6	User range setting offset value (L)	—	System
+57	CH6	User range setting offset value (H)	—	System
+58	CH6	User range setting gain value (L)	—	System
+59	CH6	User range setting gain value (H)	—	System
+60	CH7	User range setting offset value (L)	—	System
+61	CH7	User range setting offset value (H)	—	System
+62	CH7	User range setting gain value (L)	—	System
+63	CH7	User range setting gain value (H)	—	System
+64	CH8	User range setting offset value (L)	—	System
+65	CH8	User range setting offset value (H)	—	System
+66	CH8	User range setting gain value (L)	—	System
+67	CH8	User range setting gain value (H)	—	System

*1 For the R60ADV8 and the R60ADI8, this area corresponds to System area and so is not available.

• For R60DAV8, R60DAI8, R60DA8-G

Operand: (s)																																				
Device	Item	Description	Setting range	Set by																																
+0	System area	—	—	—																																
+1	Completion status	The instruction completion status is stored. • 0: Completed successfully • Other than 0: Completed with an error (error code)	—	System																																
+2	Save data type setting*2	Specify the user range setting for reading offset/gain setting values. • 0H: User range setting 1 (current specification) • 1H: User range setting 2 (voltage specification) • 2H: User range setting 3 (voltage specification) <table border="1" style="margin-left: 20px;"> <tr> <td>b15</td><td>b14</td><td>b13</td><td>b12</td><td>b11</td><td>b10</td><td>b9</td><td>b8</td><td>b7</td><td>b6</td><td>b5</td><td>b4</td><td>b3</td><td>b2</td><td>b1</td><td>b0</td> </tr> <tr> <td>CH8</td><td>CH7</td><td>CH6</td><td>CH5</td><td>CH4</td><td>CH3</td><td>CH2</td><td>CH1</td><td colspan="8"></td> </tr> </table>	b15	b14	b13	b12	b11	b10	b9	b8	b7	b6	b5	b4	b3	b2	b1	b0	CH8	CH7	CH6	CH5	CH4	CH3	CH2	CH1									0000H to AAAAH	User
b15	b14	b13	b12	b11	b10	b9	b8	b7	b6	b5	b4	b3	b2	b1	b0																					
CH8	CH7	CH6	CH5	CH4	CH3	CH2	CH1																													
+3	System area	—	—	—																																
+4	CH1 Factory default setting offset value	—	—	System																																
+5	CH1 Factory default setting gain value	—	—	System																																
+6	CH2 Factory default setting offset value	—	—	System																																
+7	CH2 Factory default setting gain value	—	—	System																																
+8	CH3 Factory default setting offset value	—	—	System																																
+9	CH3 Factory default setting gain value	—	—	System																																
+10	CH4 Factory default setting offset value	—	—	System																																
+11	CH4 Factory default setting gain value	—	—	System																																
+12	CH5 Factory default setting offset value	—	—	System																																
+13	CH5 Factory default setting gain value	—	—	System																																
+14	CH6 Factory default setting offset value	—	—	System																																
+15	CH6 Factory default setting gain value	—	—	System																																
+16	CH7 Factory default setting offset value	—	—	System																																
+17	CH7 Factory default setting gain value	—	—	System																																
+18	CH8 Factory default setting offset value	—	—	System																																
+19	CH8 Factory default setting gain value	—	—	System																																
+20	CH1 User range setting offset value	—	—	System																																
+21	CH1 User range setting gain value	—	—	System																																
+22	CH2 User range setting offset value	—	—	System																																
+23	CH2 User range setting gain value	—	—	System																																
+24	CH3 User range setting offset value	—	—	System																																
+25	CH3 User range setting gain value	—	—	System																																
+26	CH4 User range setting offset value	—	—	System																																
+27	CH4 User range setting gain value	—	—	System																																
+28	CH5 User range setting offset value	—	—	System																																
+29	CH5 User range setting gain value	—	—	System																																
+30	CH6 User range setting offset value	—	—	System																																
+31	CH6 User range setting gain value	—	—	System																																
+32	CH7 User range setting offset value	—	—	System																																
+33	CH7 User range setting gain value	—	—	System																																
+34	CH8 User range setting offset value	—	—	System																																
+35	CH8 User range setting gain value	—	—	System																																
+36	System area	—	—	—																																

*2 For the R60DAV8 and the R60DAI8, this area corresponds to System area and so is not available.

• For R60TD8-G

Operand: (s)				
Device	Item	Description	Setting range	Set by
+0	System area	—	—	—
+1	Completion status	The instruction completion status is stored. • 0: Completed successfully • Other than 0: Completed with an error (error code)	—	System
+2	System area	—	—	—
+3	System area	—	—	—
+4	CH1 Factory default setting offset value (L)	—	—	System
+5	CH1 Factory default setting offset value (H)	—	—	System
+6	CH1 Factory default setting gain value (L)	—	—	System
+7	CH1 Factory default setting gain value (H)	—	—	System
+8	CH1 User range setting offset value (L)	—	—	System
+9	CH1 User range setting offset value (H)	—	—	System
+10	CH1 User range setting gain value (L)	—	—	System
+11	CH1 User range setting gain value (H)	—	—	System
+12	CH1 User range setting thermoelectromotive force offset value (L)	—	—	System
+13	CH1 User range setting thermoelectromotive force offset value (H)	—	—	System
+14	CH1 User range setting thermoelectromotive force gain value (L)	—	—	System
+15	CH1 User range setting thermoelectromotive force gain value (H)	—	—	System
+16	CH2 Factory default setting offset value (L)	—	—	System
+17	CH2 Factory default setting offset value (H)	—	—	System
+18	CH2 Factory default setting gain value (L)	—	—	System
+19	CH2 Factory default setting gain value (H)	—	—	System
+20	CH2 User range setting offset value (L)	—	—	System
+21	CH2 User range setting offset value (H)	—	—	System
+22	CH2 User range setting gain value (L)	—	—	System
+23	CH2 User range setting gain value (H)	—	—	System
+24	CH2 User range setting thermoelectromotive force offset value (L)	—	—	System
+25	CH2 User range setting thermoelectromotive force offset value (H)	—	—	System
+26	CH2 User range setting thermoelectromotive force gain value (L)	—	—	System
+27	CH2 User range setting thermoelectromotive force gain value (H)	—	—	System
+28	CH3 Factory default setting offset value (L)	—	—	System
+29	CH3 Factory default setting offset value (H)	—	—	System
+30	CH3 Factory default setting gain value (L)	—	—	System
+31	CH3 Factory default setting gain value (H)	—	—	System
+32	CH3 User range setting offset value (L)	—	—	System
+33	CH3 User range setting offset value (H)	—	—	System
+34	CH3 User range setting gain value (L)	—	—	System
+35	CH3 User range setting gain value (H)	—	—	System
+36	CH3 User range setting thermoelectromotive force offset value (L)	—	—	System
+37	CH3 User range setting thermoelectromotive force offset value (H)	—	—	System
+38	CH3 User range setting thermoelectromotive force gain value (L)	—	—	System
+39	CH3 User range setting thermoelectromotive force gain value (H)	—	—	System

Operand: (s)				
Device	Item	Description	Setting range	Set by
+40	CH4 Factory default setting offset value (L)	—	—	System
+41	CH4 Factory default setting offset value (H)	—	—	System
+42	CH4 Factory default setting gain value (L)	—	—	System
+43	CH4 Factory default setting gain value (H)	—	—	System
+44	CH4 User range setting offset value (L)	—	—	System
+45	CH4 User range setting offset value (H)	—	—	System
+46	CH4 User range setting gain value (L)	—	—	System
+47	CH4 User range setting gain value (H)	—	—	System
+48	CH4 User range setting thermoelectromotive force offset value (L)	—	—	System
+49	CH4 User range setting thermoelectromotive force offset value (H)	—	—	System
+50	CH4 User range setting thermoelectromotive force gain value (L)	—	—	System
+51	CH4 User range setting thermoelectromotive force gain value (H)	—	—	System
+52	CH5 Factory default setting offset value (L)	—	—	System
+53	CH5 Factory default setting offset value (H)	—	—	System
+54	CH5 Factory default setting gain value (L)	—	—	System
+55	CH5 Factory default setting gain value (H)	—	—	System
+56	CH5 User range setting offset value (L)	—	—	System
+57	CH5 User range setting offset value (H)	—	—	System
+58	CH5 User range setting gain value (L)	—	—	System
+59	CH5 User range setting gain value (H)	—	—	System
+60	CH5 User range setting thermoelectromotive force offset value (L)	—	—	System
+61	CH5 User range setting thermoelectromotive force offset value (H)	—	—	System
+62	CH5 User range setting thermoelectromotive force gain value (L)	—	—	System
+63	CH5 User range setting thermoelectromotive force gain value (H)	—	—	System
+64	CH6 Factory default setting offset value (L)	—	—	System
+65	CH6 Factory default setting offset value (H)	—	—	System
+66	CH6 Factory default setting gain value (L)	—	—	System
+67	CH6 Factory default setting gain value (H)	—	—	System
+68	CH6 User range setting offset value (L)	—	—	System
+69	CH6 User range setting offset value (H)	—	—	System
+70	CH6 User range setting gain value (L)	—	—	System
+71	CH6 User range setting gain value (H)	—	—	System
+72	CH6 User range setting thermoelectromotive force offset value (L)	—	—	System
+73	CH6 User range setting thermoelectromotive force offset value (H)	—	—	System
+74	CH6 User range setting thermoelectromotive force gain value (L)	—	—	System
+75	CH6 User range setting thermoelectromotive force gain value (H)	—	—	System
+76	CH7 Factory default setting offset value (L)	—	—	System
+77	CH7 Factory default setting offset value (H)	—	—	System
+78	CH7 Factory default setting gain value (L)	—	—	System
+79	CH7 Factory default setting gain value (H)	—	—	System
+80	CH7 User range setting offset value (L)	—	—	System
+81	CH7 User range setting offset value (H)	—	—	System
+82	CH7 User range setting gain value (L)	—	—	System

Operand: (s)				
Device	Item	Description	Setting range	Set by
+83	CH7 User range setting gain value (H)	—	—	System
+84	CH7 User range setting thermoelectromotive force offset value (L)	—	—	System
+85	CH7 User range setting thermoelectromotive force offset value (H)	—	—	System
+86	CH7 User range setting thermoelectromotive force gain value (L)	—	—	System
+87	CH7 User range setting thermoelectromotive force gain value (H)	—	—	System
+88	CH8 Factory default setting offset value (L)	—	—	System
+89	CH8 Factory default setting offset value (H)	—	—	System
+90	CH8 Factory default setting gain value (L)	—	—	System
+91	CH8 Factory default setting gain value (H)	—	—	System
+92	CH8 User range setting offset value (L)	—	—	System
+93	CH8 User range setting offset value (H)	—	—	System
+94	CH8 User range setting gain value (L)	—	—	System
+95	CH8 User range setting gain value (H)	—	—	System
+96	CH8 User range setting thermoelectromotive force offset value (L)	—	—	System
+97	CH8 User range setting thermoelectromotive force offset value (H)	—	—	System
+98	CH8 User range setting thermoelectromotive force gain value (L)	—	—	System
+99	CH8 User range setting thermoelectromotive force gain value (H)	—	—	System

• For R60RD8-G

Operand: (s)				
Device	Item	Description	Setting range	Set by
+0	System area	—	—	—
+1	Completion status	The instruction completion status is stored. • 0: Completed successfully • Other than 0: Completed with an error (error code)	—	System
+2	System area	—	—	—
+3	System area	—	—	—
+4	CH1 Factory default setting offset value (L)	—	—	System
+5	CH1 Factory default setting offset value (H)	—	—	System
+6	CH1 Factory default setting gain value (L)	—	—	System
+7	CH1 Factory default setting gain value (H)	—	—	System
+8	CH1 User range setting offset value (L)	—	—	System
+9	CH1 User range setting offset value (H)	—	—	System
+10	CH1 User range setting gain value (L)	—	—	System
+11	CH1 User range setting gain value (H)	—	—	System
+12	CH1 User range setting offset resistance value (L)	—	—	System
+13	CH1 User range setting offset resistance value (H)	—	—	System
+14	CH1 User range setting gain resistance value (L)	—	—	System
+15	CH1 User range setting gain resistance value (H)	—	—	System
+16	CH2 Factory default setting offset value (L)	—	—	System
+17	CH2 Factory default setting offset value (H)	—	—	System
+18	CH2 Factory default setting gain value (L)	—	—	System
+19	CH2 Factory default setting gain value (H)	—	—	System
+20	CH2 User range setting offset value (L)	—	—	System
+21	CH2 User range setting offset value (H)	—	—	System
+22	CH2 User range setting gain value (L)	—	—	System
+23	CH2 User range setting gain value (H)	—	—	System
+24	CH2 User range setting offset resistance value (L)	—	—	System
+25	CH2 User range setting offset resistance value (H)	—	—	System
+26	CH2 User range setting gain resistance value (L)	—	—	System
+27	CH2 User range setting gain resistance value (H)	—	—	System
+28	CH3 Factory default setting offset value (L)	—	—	System
+29	CH3 Factory default setting offset value (H)	—	—	System
+30	CH3 Factory default setting gain value (L)	—	—	System
+31	CH3 Factory default setting gain value (H)	—	—	System
+32	CH3 User range setting offset value (L)	—	—	System
+33	CH3 User range setting offset value (H)	—	—	System
+34	CH3 User range setting gain value (L)	—	—	System
+35	CH3 User range setting gain value (H)	—	—	System
+36	CH3 User range setting offset resistance value (L)	—	—	System
+37	CH3 User range setting offset resistance value (H)	—	—	System
+38	CH3 User range setting gain resistance value (L)	—	—	System
+39	CH3 User range setting gain resistance value (H)	—	—	System

Operand: (s)				
Device	Item	Description	Setting range	Set by
+40	CH4 Factory default setting offset value (L)	—	—	System
+41	CH4 Factory default setting offset value (H)	—	—	System
+42	CH4 Factory default setting gain value (L)	—	—	System
+43	CH4 Factory default setting gain value (H)	—	—	System
+44	CH4 User range setting offset value (L)	—	—	System
+45	CH4 User range setting offset value (H)	—	—	System
+46	CH4 User range setting gain value (L)	—	—	System
+47	CH4 User range setting gain value (H)	—	—	System
+48	CH4 User range setting offset resistance value (L)	—	—	System
+49	CH4 User range setting offset resistance value (H)	—	—	System
+50	CH4 User range setting gain resistance value (L)	—	—	System
+51	CH4 User range setting gain resistance value (H)	—	—	System
+52	CH5 Factory default setting offset value (L)	—	—	System
+53	CH5 Factory default setting offset value (H)	—	—	System
+54	CH5 Factory default setting gain value (L)	—	—	System
+55	CH5 Factory default setting gain value (H)	—	—	System
+56	CH5 User range setting offset value (L)	—	—	System
+57	CH5 User range setting offset value (H)	—	—	System
+58	CH5 User range setting gain value (L)	—	—	System
+59	CH5 User range setting gain value (H)	—	—	System
+60	CH5 User range setting offset resistance value (L)	—	—	System
+61	CH5 User range setting offset resistance value (H)	—	—	System
+62	CH5 User range setting gain resistance value (L)	—	—	System
+63	CH5 User range setting gain resistance value (H)	—	—	System
+64	CH6 Factory default setting offset value (L)	—	—	System
+65	CH6 Factory default setting offset value (H)	—	—	System
+66	CH6 Factory default setting gain value (L)	—	—	System
+67	CH6 Factory default setting gain value (H)	—	—	System
+68	CH6 User range setting offset value (L)	—	—	System
+69	CH6 User range setting offset value (H)	—	—	System
+70	CH6 User range setting gain value (L)	—	—	System
+71	CH6 User range setting gain value (H)	—	—	System
+72	CH6 User range setting offset resistance value (L)	—	—	System
+73	CH6 User range setting offset resistance value (H)	—	—	System
+74	CH6 User range setting gain resistance value (L)	—	—	System
+75	CH6 User range setting gain resistance value (H)	—	—	System
+76	CH7 Factory default setting offset value (L)	—	—	System
+77	CH7 Factory default setting offset value (H)	—	—	System
+78	CH7 Factory default setting gain value (L)	—	—	System
+79	CH7 Factory default setting gain value (H)	—	—	System
+80	CH7 User range setting offset value (L)	—	—	System
+81	CH7 User range setting offset value (H)	—	—	System
+82	CH7 User range setting gain value (L)	—	—	System

Operand: (s)				
Device	Item	Description	Setting range	Set by
+83	CH7 User range setting gain value (H)	—	—	System
+84	CH7 User range setting offset resistance value (L)	—	—	System
+85	CH7 User range setting offset resistance value (H)	—	—	System
+86	CH7 User range setting gain resistance value (L)	—	—	System
+87	CH7 User range setting gain resistance value (H)	—	—	System
+88	CH8 Factory default setting offset value (L)	—	—	System
+89	CH8 Factory default setting offset value (H)	—	—	System
+90	CH8 Factory default setting gain value (L)	—	—	System
+91	CH8 Factory default setting gain value (H)	—	—	System
+92	CH8 User range setting offset value (L)	—	—	System
+93	CH8 User range setting offset value (H)	—	—	System
+94	CH8 User range setting gain value (L)	—	—	System
+95	CH8 User range setting gain value (H)	—	—	System
+96	CH8 User range setting offset resistance value (L)	—	—	System
+97	CH8 User range setting offset resistance value (H)	—	—	System
+98	CH8 User range setting gain resistance value (L)	—	—	System
+99	CH8 User range setting gain resistance value (H)	—	—	System

• For R60AD16-G

Operand: (s)					
Device	Item	Description	Setting range	Set by	
+0	System area	—	—	—	
+1	Completion status	The instruction completion status is stored. • 0: Completed successfully • Other than 0: Completed with an error (error code)	—	System	
+2	Save data type setting	Specifies which one of the voltage and current is read as the offset/gain setting value. • 0: Voltage specification • 1: Current specification b15 b14 b13 b12 b11 b10 b9 b8 b7 b6 b5 b4 b3 b2 b1 b0 CH16 CH15 CH14 CH13 CH12 CH11 CH10 CH9 CH8 CH7 CH6 CH5 CH4 CH3 CH2 CH1	0000H to FFFFH	User	
+3	System area	—	—	—	
+4	CH1 Factory default setting offset value (L)	—	—	System	
+5	CH1 Factory default setting offset value (H)	—	—	System	
+6	CH1 Factory default setting gain value (L)	—	—	System	
+7	CH1 Factory default setting gain value (H)	—	—	System	
+8	CH2 Factory default setting offset value (L)	—	—	System	
+9	CH2 Factory default setting offset value (H)	—	—	System	
+10	CH2 Factory default setting gain value (L)	—	—	System	
+11	CH2 Factory default setting gain value (H)	—	—	System	
+12	CH3 Factory default setting offset value (L)	—	—	System	
+13	CH3 Factory default setting offset value (H)	—	—	System	
+14	CH3 Factory default setting gain value (L)	—	—	System	
+15	CH3 Factory default setting gain value (H)	—	—	System	
+16	CH4 Factory default setting offset value (L)	—	—	System	
+17	CH4 Factory default setting offset value (H)	—	—	System	
+18	CH4 Factory default setting gain value (L)	—	—	System	
+19	CH4 Factory default setting gain value (H)	—	—	System	
+20	CH5 Factory default setting offset value (L)	—	—	System	
+21	CH5 Factory default setting offset value (H)	—	—	System	
+22	CH5 Factory default setting gain value (L)	—	—	System	
+23	CH5 Factory default setting gain value (H)	—	—	System	
+24	CH6 Factory default setting offset value (L)	—	—	System	
+25	CH6 Factory default setting offset value (H)	—	—	System	
+26	CH6 Factory default setting gain value (L)	—	—	System	
+27	CH6 Factory default setting gain value (H)	—	—	System	
+28	CH7 Factory default setting offset value (L)	—	—	System	
+29	CH7 Factory default setting offset value (H)	—	—	System	
+30	CH7 Factory default setting gain value (L)	—	—	System	
+31	CH7 Factory default setting gain value (H)	—	—	System	
+32	CH8 Factory default setting offset value (L)	—	—	System	
+33	CH8 Factory default setting offset value (H)	—	—	System	
+34	CH8 Factory default setting gain value (L)	—	—	System	
+35	CH8 Factory default setting gain value (H)	—	—	System	
+36	CH9 Factory default setting offset value (L)	—	—	System	
+37	CH9 Factory default setting offset value (H)	—	—	System	
+38	CH9 Factory default setting gain value (L)	—	—	System	
+39	CH9 Factory default setting gain value (H)	—	—	System	
+40	CH10 Factory default setting offset value (L)	—	—	System	
+41	CH10 Factory default setting offset value (H)	—	—	System	
+42	CH10 Factory default setting gain value (L)	—	—	System	
+43	CH10 Factory default setting gain value (H)	—	—	System	
+44	CH11 Factory default setting offset value (L)	—	—	System	

Operand: (s)				
Device	Item	Description	Setting range	Set by
+45	CH11	Factory default setting offset value (H)	—	System
+46	CH11	Factory default setting gain value (L)	—	System
+47	CH11	Factory default setting gain value (H)	—	System
+48	CH12	Factory default setting offset value (L)	—	System
+49	CH12	Factory default setting offset value (H)	—	System
+50	CH12	Factory default setting gain value (L)	—	System
+51	CH12	Factory default setting gain value (H)	—	System
+52	CH13	Factory default setting offset value (L)	—	System
+53	CH13	Factory default setting offset value (H)	—	System
+54	CH13	Factory default setting gain value (L)	—	System
+55	CH13	Factory default setting gain value (H)	—	System
+56	CH14	Factory default setting offset value (L)	—	System
+57	CH14	Factory default setting offset value (H)	—	System
+58	CH14	Factory default setting gain value (L)	—	System
+59	CH14	Factory default setting gain value (H)	—	System
+60	CH15	Factory default setting offset value (L)	—	System
+61	CH15	Factory default setting offset value (H)	—	System
+62	CH15	Factory default setting gain value (L)	—	System
+63	CH15	Factory default setting gain value (H)	—	System
+64	CH16	Factory default setting offset value (L)	—	System
+65	CH16	Factory default setting offset value (H)	—	System
+66	CH16	Factory default setting gain value (L)	—	System
+67	CH16	Factory default setting gain value (H)	—	System
+68	CH1	User range setting offset value (L)	—	System
+69	CH1	User range setting offset value (H)	—	System
+70	CH1	User range setting gain value (L)	—	System
+71	CH1	User range setting gain value (H)	—	System
+72	CH2	User range setting offset value (L)	—	System
+73	CH2	User range setting offset value (H)	—	System
+74	CH2	User range setting gain value (L)	—	System
+75	CH2	User range setting gain value (H)	—	System
+76	CH3	User range setting offset value (L)	—	System
+77	CH3	User range setting offset value (H)	—	System
+78	CH3	User range setting gain value (L)	—	System
+79	CH3	User range setting gain value (H)	—	System
+80	CH4	User range setting offset value (L)	—	System
+81	CH4	User range setting offset value (H)	—	System
+82	CH4	User range setting gain value (L)	—	System
+83	CH4	User range setting gain value (H)	—	System
+84	CH5	User range setting offset value (L)	—	System
+85	CH5	User range setting offset value (H)	—	System
+86	CH5	User range setting gain value (L)	—	System
+87	CH5	User range setting gain value (H)	—	System
+88	CH6	User range setting offset value (L)	—	System
+89	CH6	User range setting offset value (H)	—	System
+90	CH6	User range setting gain value (L)	—	System
+91	CH6	User range setting gain value (H)	—	System
+92	CH7	User range setting offset value (L)	—	System
+93	CH7	User range setting offset value (H)	—	System
+94	CH7	User range setting gain value (L)	—	System
+95	CH7	User range setting gain value (H)	—	System
+96	CH8	User range setting offset value (L)	—	System

Operand: (s)				
Device	Item	Description	Setting range	Set by
+97	CH8	User range setting offset value (H)	—	System
+98	CH8	User range setting gain value (L)	—	System
+99	CH8	User range setting gain value (H)	—	System
+100	CH9	User range setting offset value (L)	—	System
+101	CH9	User range setting offset value (H)	—	System
+102	CH9	User range setting gain value (L)	—	System
+103	CH9	User range setting gain value (H)	—	System
+104	CH10	User range setting offset value (L)	—	System
+105	CH10	User range setting offset value (H)	—	System
+106	CH10	User range setting gain value (L)	—	System
+107	CH10	User range setting gain value (H)	—	System
+108	CH11	User range setting offset value (L)	—	System
+109	CH11	User range setting offset value (H)	—	System
+110	CH11	User range setting gain value (L)	—	System
+111	CH11	User range setting gain value (H)	—	System
+112	CH12	User range setting offset value (L)	—	System
+113	CH12	User range setting offset value (H)	—	System
+114	CH12	User range setting gain value (L)	—	System
+115	CH12	User range setting gain value (H)	—	System
+116	CH13	User range setting offset value (L)	—	System
+117	CH13	User range setting offset value (H)	—	System
+118	CH13	User range setting gain value (L)	—	System
+119	CH13	User range setting gain value (H)	—	System
+120	CH14	User range setting offset value (L)	—	System
+121	CH14	User range setting offset value (H)	—	System
+122	CH14	User range setting gain value (L)	—	System
+123	CH14	User range setting gain value (H)	—	System
+124	CH15	User range setting offset value (L)	—	System
+125	CH15	User range setting offset value (H)	—	System
+126	CH15	User range setting gain value (L)	—	System
+127	CH15	User range setting gain value (H)	—	System
+128	CH16	User range setting offset value (L)	—	System
+129	CH16	User range setting offset value (H)	—	System
+130	CH16	User range setting gain value (L)	—	System
+131	CH16	User range setting gain value (H)	—	System

• For R60DA16-G

Operand: (s)																																				
Device	Item	Description	Setting range	Set by																																
+0	System area	—	—	—																																
+1	Completion status	The instruction completion status is stored. • 0: Completed successfully • Other than 0: Completed with an error (error code)	—	System																																
+2	Save data type setting 1	Specify the user range setting for reading offset/gain setting values. This device allows a specification from CH1 to CH8. • 0H: User range setting 1 (current specification) • 1H: User range setting 2 (voltage specification) • 2H: User range setting 3 (voltage specification) <table border="1" style="width: 100%; border-collapse: collapse;"> <tr> <td>b15</td><td>b14</td><td>b13</td><td>b12</td><td>b11</td><td>b10</td><td>b9</td><td>b8</td><td>b7</td><td>b6</td><td>b5</td><td>b4</td><td>b3</td><td>b2</td><td>b1</td><td>b0</td> </tr> <tr> <td>CH8</td><td>CH7</td><td>CH6</td><td>CH5</td><td>CH4</td><td>CH3</td><td>CH2</td><td>CH1</td><td colspan="8"></td> </tr> </table>	b15	b14	b13	b12	b11	b10	b9	b8	b7	b6	b5	b4	b3	b2	b1	b0	CH8	CH7	CH6	CH5	CH4	CH3	CH2	CH1									0000H to AAAAH	User
b15	b14	b13	b12	b11	b10	b9	b8	b7	b6	b5	b4	b3	b2	b1	b0																					
CH8	CH7	CH6	CH5	CH4	CH3	CH2	CH1																													
+3	Save data type setting 2	Specify the user range setting for reading offset/gain setting values. This device allows a specification from CH9 to CH16. • 0H: User range setting 1 (current specification) • 1H: User range setting 2 (voltage specification) • 2H: User range setting 3 (voltage specification) <table border="1" style="width: 100%; border-collapse: collapse;"> <tr> <td>b15</td><td>b14</td><td>b13</td><td>b12</td><td>b11</td><td>b10</td><td>b9</td><td>b8</td><td>b7</td><td>b6</td><td>b5</td><td>b4</td><td>b3</td><td>b2</td><td>b1</td><td>b0</td> </tr> <tr> <td>CH16</td><td>CH15</td><td>CH14</td><td>CH13</td><td>CH12</td><td>CH11</td><td>CH10</td><td>CH9</td><td colspan="8"></td> </tr> </table>	b15	b14	b13	b12	b11	b10	b9	b8	b7	b6	b5	b4	b3	b2	b1	b0	CH16	CH15	CH14	CH13	CH12	CH11	CH10	CH9									0000H to AAAAH	User
b15	b14	b13	b12	b11	b10	b9	b8	b7	b6	b5	b4	b3	b2	b1	b0																					
CH16	CH15	CH14	CH13	CH12	CH11	CH10	CH9																													
+4	CH1 Factory default setting offset value	—	—	System																																
+5	CH1 Factory default setting gain value	—	—	System																																
+6	CH2 Factory default setting offset value	—	—	System																																
+7	CH2 Factory default setting gain value	—	—	System																																
+8	CH3 Factory default setting offset value	—	—	System																																
+9	CH3 Factory default setting gain value	—	—	System																																
+10	CH4 Factory default setting offset value	—	—	System																																
+11	CH4 Factory default setting gain value	—	—	System																																
+12	CH5 Factory default setting offset value	—	—	System																																
+13	CH5 Factory default setting gain value	—	—	System																																
+14	CH6 Factory default setting offset value	—	—	System																																
+15	CH6 Factory default setting gain value	—	—	System																																
+16	CH7 Factory default setting offset value	—	—	System																																
+17	CH7 Factory default setting gain value	—	—	System																																
+18	CH8 Factory default setting offset value	—	—	System																																
+19	CH8 Factory default setting gain value	—	—	System																																
+20	CH9 Factory default setting offset value	—	—	System																																
+21	CH9 Factory default setting gain value	—	—	System																																
+22	CH10 Factory default setting offset value	—	—	System																																
+23	CH10 Factory default setting gain value	—	—	System																																
+24	CH11 Factory default setting offset value	—	—	System																																
+25	CH11 Factory default setting gain value	—	—	System																																
+26	CH12 Factory default setting offset value	—	—	System																																
+27	CH12 Factory default setting gain value	—	—	System																																
+28	CH13 Factory default setting offset value	—	—	System																																
+29	CH13 Factory default setting gain value	—	—	System																																
+30	CH14 Factory default setting offset value	—	—	System																																
+31	CH14 Factory default setting gain value	—	—	System																																
+32	CH15 Factory default setting offset value	—	—	System																																
+33	CH15 Factory default setting gain value	—	—	System																																
+34	CH16 Factory default setting offset value	—	—	System																																
+35	CH16 Factory default setting gain value	—	—	System																																
+36	CH1 User range setting offset value	—	—	System																																
+37	CH1 User range setting gain value	—	—	System																																
+38	CH2 User range setting offset value	—	—	System																																

Operand: (s)				
Device	Item	Description	Setting range	Set by
+39	CH2 User range setting gain value	—	—	System
+40	CH3 User range setting offset value	—	—	System
+41	CH3 User range setting gain value	—	—	System
+42	CH4 User range setting offset value	—	—	System
+43	CH4 User range setting gain value	—	—	System
+44	CH5 User range setting offset value	—	—	System
+45	CH5 User range setting gain value	—	—	System
+46	CH6 User range setting offset value	—	—	System
+47	CH6 User range setting gain value	—	—	System
+48	CH7 User range setting offset value	—	—	System
+49	CH7 User range setting gain value	—	—	System
+50	CH8 User range setting offset value	—	—	System
+51	CH8 User range setting gain value	—	—	System
+52	CH9 User range setting offset value	—	—	System
+53	CH9 User range setting gain value	—	—	System
+54	CH10 User range setting offset value	—	—	System
+55	CH10 User range setting gain value	—	—	System
+56	CH11 User range setting offset value	—	—	System
+57	CH11 User range setting gain value	—	—	System
+58	CH12 User range setting offset value	—	—	System
+59	CH12 User range setting gain value	—	—	System
+60	CH13 User range setting offset value	—	—	System
+61	CH13 User range setting gain value	—	—	System
+62	CH14 User range setting offset value	—	—	System
+63	CH14 User range setting gain value	—	—	System
+64	CH15 User range setting offset value	—	—	System
+65	CH15 User range setting gain value	—	—	System
+66	CH16 User range setting offset value	—	—	System
+67	CH16 User range setting gain value	—	—	System
+68	System area	—	—	—

Processing details

- These instructions read the offset/gain setting values of the user range settings of an analog module into the CPU module.
- Execution and normal/error completion of the G(P).OGLOAD instruction can be checked with the completion device specified by the setting data (d) and the completion status indication device (d)+1.

• Completion device (d)

Turns on during END processing of the scan that arises upon completion of the G(P).OGLOAD instruction, and turns off during the next END processing.

• Completion status indication device (d)+1

Turns on or off depending on the status resulting from completion of the G(P).OGLOAD instruction.

When completed normally: Unchanged from off.

When completed with an error: Turns on during END processing of the scan that arises upon completion of the G(P).OGLOAD instruction, and turns off during the next END processing.

- The following figure shows the operation at the completion of the G(P).OGLOAD instruction.

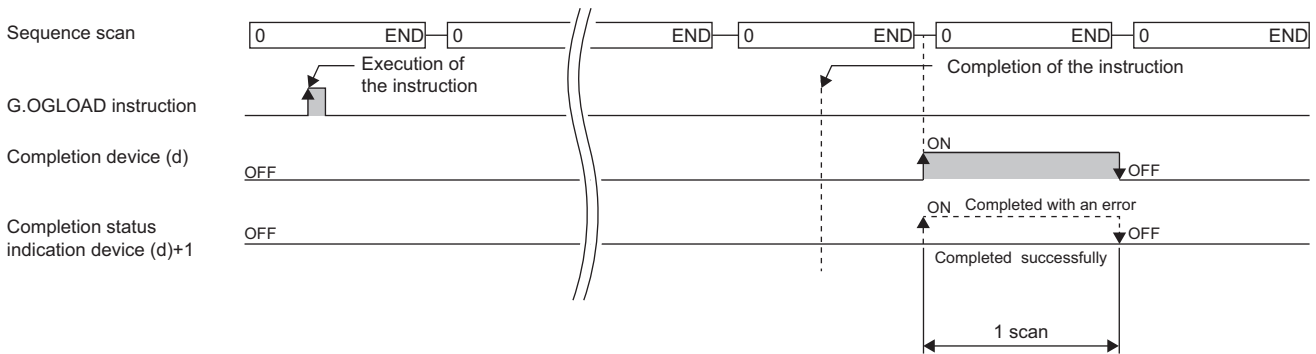

Program example

The following figure shows an example of a program which uses the G(P).OGLOAD instruction with the R60AD4.

- Program content

Description

When "Dedicated Instruction Execution Request" (M11) is turned on, the offset/gain settings of the analog module mounted at the position of I/O numbers X/Y10 to X/Y1F are read out to the "head device (D100) for storing the offset gain setting" and later.

- Label setting

Classification	Label name	Description	Device
Module label	—	—	—
Label to be defined	Define the global label as shown below.		
	Label Name	Data Type	Class Assign (Device/Label)
	G_bOgStartReq	Bit	VAR_GLOBAL M11
	G_bReadStart	Bit	VAR_GLOBAL M12
	G_bWriteStart	Bit	VAR_GLOBAL M13
	G_bnOgLoadCmpFlg	Bit(0..1)	VAR_GLOBAL M20
	G_bnOgStorCmpFlg	Bit(0..1)	VAR_GLOBAL M30
	G_wCtrlDataTopDev	Word [Signed]	VAR_GLOBAL D100
	G_uSaveDataType	Word [Unsigned]/Bit String [16-bit]	VAR_GLOBAL D102
	G_bReadAbnormalComplete	Bit	VAR_GLOBAL F0
	G_bWriteAbnormalComplete	Bit	VAR_GLOBAL F1

• Program example

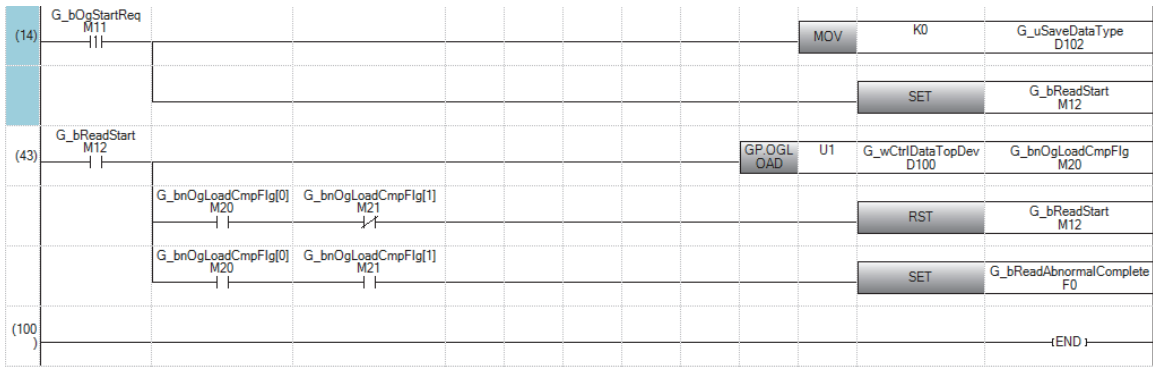

- (14) Set control data.
Save data types need not be set for the following modules.
 - R60ADV8
 - R60ADI8
 - R60DAV8
 - R60DAI8
 - R60TD8-G
 - R60RD8-G
- (43) Read the offset/gain settings.

Precautions

In the following cases, the G(P).OGLOAD instruction will be disabled.

- The module has been set as a target of synchronization.
- The normal mode (high speed: 1μs/CH) or simultaneous conversion mode has been selected on the high speed analog-digital converter module.
- The wave output mode has been selected on the D/A converter module.
- The high-speed output mode has been selected on the high speed digital-analog converter module.

Operation error

Error code ((s)+1)	Description
1863H	The value set in the save data type setting 1 (s)+2 or the save data type setting 2 (s)+3 is out of the valid range.

10.3 Restoring the User Range Setting Values

G(P).OGSTOR



These instructions restore the offset/gain settings in the user range setting stored in a CPU module into an analog module.

Ladder	ST
	<pre>ENO:=G_OGSTOR(EN,U,s,d); ENO:=GP_OGSTOR(EN,U,s,d);</pre>

FBD/LD

Execution condition

Instruction	Execution condition
G.OGSTOR	
GP.OGSTOR	

Setting data

Description, range, data type

Operand	Description	Range	Data type	Data type (label)
(U)	Start I/O number (first three digits in four-digit hexadecimal representation) of a module	0000H to 00FEH	<ul style="list-style-type: none"> 16-bit unsigned binary 16-bit signed binary 	ANY16
(s) ^{*1}	Start device where the control data is stored	Predefined devices	Device name	ANY16 ^{*2}
(d)	Device to be turned on for one scan when instruction processing completes. If the instruction is completed with an error, (d)+1 is also turned on.	Predefined devices	Bit	ANYBIT_ARRAY ^{*3} (Number of elements: 2)
EN	Execution condition	—	Bit	BOOL
ENO	Execution result	—	Bit	BOOL

*1 Specify the device that is specified in (s) when the G(P).OGLOAD instruction is to be executed. The data read with the G(P).OGLOAD instruction must not be changed. Otherwise, normal operation cannot be guaranteed.

*2 When specifying setting data by using a label, define an array to secure enough operation area and specify an element of the array label.

*3 When specifying setting data by using a label, use an array with two or more elements.

■Applicable devices

Operand	Bit		Word				Double word		Indirect specification	Constant			Others (U)
	X, Y, M, L, SM, F, B, SB, FX, FY	J□□	T, ST, C, D, W, SD, SW, FD, R, ZR, RD	U□\G□, J□□□, U3E□(H)G□	Z	LT, LST, LC	LZ	K, H, E, \$					
(U)	—	—	○	—	—	—	—	○	○	—	—	○	
(s)	—	—	○*1	—	—	—	—	○	—	—	—	—	
(d)	○*2	—	○*3	—	—	—	—	○	—	—	—	—	

*1 FD cannot be used.

*2 FX and FY cannot be used.

*3 T, ST, C, and FD cannot be used.

■Control data

- For R60AD4, R60ADH4

Operand: (s)									
Device	Item	Description	Setting range	Set by					
+0	System area	—	—	—					
+1	Completion status	The instruction completion status is stored. • 0: Completed successfully • Other than 0: Completed with an error (error code)	—	System					
+2	Save data type setting	Used to store the set value that was set for Save data type setting (s)+2 in the G(P).OGLoad instruction. • 0: Voltage specification • 1: Current specification <div style="display: flex; align-items: center; gap: 20px;"> b15 ... b3 b2 b1 b0 </div> <table border="1" style="margin-left: auto; margin-right: auto;"> <tr> <td style="width: 100px; text-align: center;">0</td> <td style="width: 20px; text-align: center;">CH4</td> <td style="width: 20px; text-align: center;">CH3</td> <td style="width: 20px; text-align: center;">CH2</td> <td style="width: 20px; text-align: center;">CH1</td> </tr> </table>	0	CH4	CH3	CH2	CH1	0000H to 000FH	System
0	CH4	CH3	CH2	CH1					
+3	System area	—	—	—					
+4	CH1 Factory default setting offset value (L)	—	—	System					
+5	CH1 Factory default setting offset value (H)	—	—	System					
+6	CH1 Factory default setting gain value (L)	—	—	System					
+7	CH1 Factory default setting gain value (H)	—	—	System					
+8	CH2 Factory default setting offset value (L)	—	—	System					
+9	CH2 Factory default setting offset value (H)	—	—	System					
+10	CH2 Factory default setting gain value (L)	—	—	System					
+11	CH2 Factory default setting gain value (H)	—	—	System					
+12	CH3 Factory default setting offset value (L)	—	—	System					
+13	CH3 Factory default setting offset value (H)	—	—	System					
+14	CH3 Factory default setting gain value (L)	—	—	System					
+15	CH3 Factory default setting gain value (H)	—	—	System					
+16	CH4 Factory default setting offset value (L)	—	—	System					
+17	CH4 Factory default setting offset value (H)	—	—	System					
+18	CH4 Factory default setting gain value (L)	—	—	System					
+19	CH4 Factory default setting gain value (H)	—	—	System					
+20	CH1 User range setting offset value (L)	—	—	System					
+21	CH1 User range setting offset value (H)	—	—	System					
+22	CH1 User range setting gain value (L)	—	—	System					
+23	CH1 User range setting gain value (H)	—	—	System					
+24	CH2 User range setting offset value (L)	—	—	System					
+25	CH2 User range setting offset value (H)	—	—	System					
+26	CH2 User range setting gain value (L)	—	—	System					
+27	CH2 User range setting gain value (H)	—	—	System					
+28	CH3 User range setting offset value (L)	—	—	System					
+29	CH3 User range setting offset value (H)	—	—	System					
+30	CH3 User range setting gain value (L)	—	—	System					
+31	CH3 User range setting gain value (H)	—	—	System					

Operand: (s)				
Device	Item	Description	Setting range	Set by
+32	CH4 User range setting offset value (L)	—	—	System
+33	CH4 User range setting offset value (H)	—	—	System
+34	CH4 User range setting gain value (L)	—	—	System
+35	CH4 User range setting gain value (H)	—	—	System

- For R60DA4, R60DAH4

Operand: (s)				
Device	Item	Description	Setting range	Set by
+0	System area	—	—	—
+1	Completion status	The instruction completion status is stored. • 0: Completed successfully • Other than 0: Completed with an error (error code)	—	System
+2	Save data type setting	Used to store the set value that was set for Save data type setting (s)+2 in the G(P).OGLOAD instruction. • 0: User range setting (voltage specification) • 1: User range setting (current specification) <div style="display: flex; align-items: center; border: 1px solid black; padding: 2px;"> b15 ... b3 b2 b1 b0 <div style="display: flex; border: 1px solid black; padding: 2px;"> <div style="width: 100px; text-align: center;">0</div> <div style="width: 20px; text-align: center;">CH4</div> <div style="width: 20px; text-align: center;">CH3</div> <div style="width: 20px; text-align: center;">CH2</div> <div style="width: 20px; text-align: center;">CH1</div> </div> </div>	0000H to 000FH	System
+3	System area	—	—	—
+4	CH1 Factory default setting offset value	—	—	System
+5	CH1 Factory default setting gain value	—	—	System
+6	CH2 Factory default setting offset value	—	—	System
+7	CH2 Factory default setting gain value	—	—	System
+8	CH3 Factory default setting offset value	—	—	System
+9	CH3 Factory default setting gain value	—	—	System
+10	CH4 Factory default setting offset value	—	—	System
+11	CH4 Factory default setting gain value	—	—	System
+12	CH1 User range setting offset value	—	—	System
+13	CH1 User range setting gain value	—	—	System
+14	CH2 User range setting offset value	—	—	System
+15	CH2 User range setting gain value	—	—	System
+16	CH3 User range setting offset value	—	—	System
+17	CH3 User range setting gain value	—	—	System
+18	CH4 User range setting offset value	—	—	System
+19	CH4 User range setting gain value	—	—	System

• For R60ADV8, R60ADI8, R60AD8-G

Operand: (s)																								
Device	Item	Description	Setting range	Set by																				
+0	System area	—	—	—																				
+1	Completion status	The instruction completion status is stored. • 0: Completed successfully • Other than 0: Completed with an error (error code)	—	System																				
+2	Save data type setting*1	Used to store the set value that was set for Save data type setting (s)+2 in the G(P).OGLOAD instruction. • 0: Voltage specification • 1: Current specification <table border="1" style="width: 100%; border-collapse: collapse;"> <tr> <td style="width: 10%;">b15</td> <td style="width: 10%;">...</td> <td style="width: 10%;">b7</td> <td style="width: 10%;">b6</td> <td style="width: 10%;">b5</td> <td style="width: 10%;">b4</td> <td style="width: 10%;">b3</td> <td style="width: 10%;">b2</td> <td style="width: 10%;">b1</td> <td style="width: 10%;">b0</td> </tr> <tr> <td colspan="2" style="text-align: center;">0</td> <td>CH8</td> <td>CH7</td> <td>CH6</td> <td>CH5</td> <td>CH4</td> <td>CH3</td> <td>CH2</td> <td>CH1</td> </tr> </table>	b15	...	b7	b6	b5	b4	b3	b2	b1	b0	0		CH8	CH7	CH6	CH5	CH4	CH3	CH2	CH1	0000H to 00FFH	System
b15	...	b7	b6	b5	b4	b3	b2	b1	b0															
0		CH8	CH7	CH6	CH5	CH4	CH3	CH2	CH1															
+3	System area	—	—	—																				
+4	CH1 Factory default setting offset value (L)	—	—	System																				
+5	CH1 Factory default setting offset value (H)	—	—	System																				
+6	CH1 Factory default setting gain value (L)	—	—	System																				
+7	CH1 Factory default setting gain value (H)	—	—	System																				
+8	CH2 Factory default setting offset value (L)	—	—	System																				
+9	CH2 Factory default setting offset value (H)	—	—	System																				
+10	CH2 Factory default setting gain value (L)	—	—	System																				
+11	CH2 Factory default setting gain value (H)	—	—	System																				
+12	CH3 Factory default setting offset value (L)	—	—	System																				
+13	CH3 Factory default setting offset value (H)	—	—	System																				
+14	CH3 Factory default setting gain value (L)	—	—	System																				
+15	CH3 Factory default setting gain value (H)	—	—	System																				
+16	CH4 Factory default setting offset value (L)	—	—	System																				
+17	CH4 Factory default setting offset value (H)	—	—	System																				
+18	CH4 Factory default setting gain value (L)	—	—	System																				
+19	CH4 Factory default setting gain value (H)	—	—	System																				
+20	CH5 Factory default setting offset value (L)	—	—	System																				
+21	CH5 Factory default setting offset value (H)	—	—	System																				
+22	CH5 Factory default setting gain value (L)	—	—	System																				
+23	CH5 Factory default setting gain value (H)	—	—	System																				
+24	CH6 Factory default setting offset value (L)	—	—	System																				
+25	CH6 Factory default setting offset value (H)	—	—	System																				
+26	CH6 Factory default setting gain value (L)	—	—	System																				
+27	CH6 Factory default setting gain value (H)	—	—	System																				
+28	CH7 Factory default setting offset value (L)	—	—	System																				
+29	CH7 Factory default setting offset value (H)	—	—	System																				
+30	CH7 Factory default setting gain value (L)	—	—	System																				
+31	CH7 Factory default setting gain value (H)	—	—	System																				
+32	CH8 Factory default setting offset value (L)	—	—	System																				
+33	CH8 Factory default setting offset value (H)	—	—	System																				
+34	CH8 Factory default setting gain value (L)	—	—	System																				
+35	CH8 Factory default setting gain value (H)	—	—	System																				
+36	CH1 User range setting offset value (L)	—	—	System																				
+37	CH1 User range setting offset value (H)	—	—	System																				
+38	CH1 User range setting gain value (L)	—	—	System																				
+39	CH1 User range setting gain value (H)	—	—	System																				
+40	CH2 User range setting offset value (L)	—	—	System																				
+41	CH2 User range setting offset value (H)	—	—	System																				
+42	CH2 User range setting gain value (L)	—	—	System																				
+43	CH2 User range setting gain value (H)	—	—	System																				
+44	CH3 User range setting offset value (L)	—	—	System																				

Operand: (s)				
Device	Item	Description	Setting range	Set by
+45	CH3	User range setting offset value (H)	—	System
+46	CH3	User range setting gain value (L)	—	System
+47	CH3	User range setting gain value (H)	—	System
+48	CH4	User range setting offset value (L)	—	System
+49	CH4	User range setting offset value (H)	—	System
+50	CH4	User range setting gain value (L)	—	System
+51	CH4	User range setting gain value (H)	—	System
+52	CH5	User range setting offset value (L)	—	System
+53	CH5	User range setting offset value (H)	—	System
+54	CH5	User range setting gain value (L)	—	System
+55	CH5	User range setting gain value (H)	—	System
+56	CH6	User range setting offset value (L)	—	System
+57	CH6	User range setting offset value (H)	—	System
+58	CH6	User range setting gain value (L)	—	System
+59	CH6	User range setting gain value (H)	—	System
+60	CH7	User range setting offset value (L)	—	System
+61	CH7	User range setting offset value (H)	—	System
+62	CH7	User range setting gain value (L)	—	System
+63	CH7	User range setting gain value (H)	—	System
+64	CH8	User range setting offset value (L)	—	System
+65	CH8	User range setting offset value (H)	—	System
+66	CH8	User range setting gain value (L)	—	System
+67	CH8	User range setting gain value (H)	—	System

*1 For the R60ADV8 and the R60ADI8, this area corresponds to System area and so is not available.

• For R60DAV8, R60DAI8, R60DA8-G

Operand: (s)																																				
Device	Item	Description	Setting range	Set by																																
+0	System area	—	—	—																																
+1	Completion status	The instruction completion status is stored. • 0: Completed successfully • Other than 0: Completed with an error (error code)	—	System																																
+2	Save data type setting* ²	Used to store the set value that was set for Save data type setting (s)+2 in the G(P).OGLOAD instruction. • 0H: User range setting 1 (current specification) • 1H: User range setting 2 (voltage specification) • 2H: User range setting 3 (voltage specification) <table border="1" style="margin-left: 20px;"> <tr> <td>b15</td><td>b14</td><td>b13</td><td>b12</td><td>b11</td><td>b10</td><td>b9</td><td>b8</td><td>b7</td><td>b6</td><td>b5</td><td>b4</td><td>b3</td><td>b2</td><td>b1</td><td>b0</td> </tr> <tr> <td>CH8</td><td>CH7</td><td>CH6</td><td>CH5</td><td>CH4</td><td>CH3</td><td>CH2</td><td>CH1</td><td colspan="8"></td> </tr> </table>	b15	b14	b13	b12	b11	b10	b9	b8	b7	b6	b5	b4	b3	b2	b1	b0	CH8	CH7	CH6	CH5	CH4	CH3	CH2	CH1									0000H to AAAAH	System
b15	b14	b13	b12	b11	b10	b9	b8	b7	b6	b5	b4	b3	b2	b1	b0																					
CH8	CH7	CH6	CH5	CH4	CH3	CH2	CH1																													
+3	System area	—	—	—																																
+4	CH1 Factory default setting offset value	—	—	System																																
+5	CH1 Factory default setting gain value	—	—	System																																
+6	CH2 Factory default setting offset value	—	—	System																																
+7	CH2 Factory default setting gain value	—	—	System																																
+8	CH3 Factory default setting offset value	—	—	System																																
+9	CH3 Factory default setting gain value	—	—	System																																
+10	CH4 Factory default setting offset value	—	—	System																																
+11	CH4 Factory default setting gain value	—	—	System																																
+12	CH5 Factory default setting offset value	—	—	System																																
+13	CH5 Factory default setting gain value	—	—	System																																
+14	CH6 Factory default setting offset value	—	—	System																																
+15	CH6 Factory default setting gain value	—	—	System																																
+16	CH7 Factory default setting offset value	—	—	System																																
+17	CH7 Factory default setting gain value	—	—	System																																
+18	CH8 Factory default setting offset value	—	—	System																																
+19	CH8 Factory default setting gain value	—	—	System																																
+20	CH1 User range setting offset value	—	—	System																																
+21	CH1 User range setting gain value	—	—	System																																
+22	CH2 User range setting offset value	—	—	System																																
+23	CH2 User range setting gain value	—	—	System																																
+24	CH3 User range setting offset value	—	—	System																																
+25	CH3 User range setting gain value	—	—	System																																
+26	CH4 User range setting offset value	—	—	System																																
+27	CH4 User range setting gain value	—	—	System																																
+28	CH5 User range setting offset value	—	—	System																																
+29	CH5 User range setting gain value	—	—	System																																
+30	CH6 User range setting offset value	—	—	System																																
+31	CH6 User range setting gain value	—	—	System																																
+32	CH7 User range setting offset value	—	—	System																																
+33	CH7 User range setting gain value	—	—	System																																
+34	CH8 User range setting offset value	—	—	System																																
+35	CH8 User range setting gain value	—	—	System																																
+36	System area	—	—	—																																

*2 For the R60DAV8 and the R60DAI8, this area corresponds to System area and so is not available.

• For R60TD8-G

Operand: (s)				
Device	Item	Description	Setting range	Set by
+0	System area	—	—	—
+1	Completion status	The instruction completion status is stored. • 0: Completed successfully • Other than 0: Completed with an error (error code)	—	System
+2	System area	—	—	—
+3	System area	—	—	—
+4	CH1 Factory default setting offset value (L)	—	—	System
+5	CH1 Factory default setting offset value (H)	—	—	System
+6	CH1 Factory default setting gain value (L)	—	—	System
+7	CH1 Factory default setting gain value (H)	—	—	System
+8	CH1 User range setting offset value (L)	—	—	System
+9	CH1 User range setting offset value (H)	—	—	System
+10	CH1 User range setting gain value (L)	—	—	System
+11	CH1 User range setting gain value (H)	—	—	System
+12	CH1 User range setting thermoelectromotive force offset value (L)	—	—	System
+13	CH1 User range setting thermoelectromotive force offset value (H)	—	—	System
+14	CH1 User range setting thermoelectromotive force gain value (L)	—	—	System
+15	CH1 User range setting thermoelectromotive force gain value (H)	—	—	System
+16	CH2 Factory default setting offset value (L)	—	—	System
+17	CH2 Factory default setting offset value (H)	—	—	System
+18	CH2 Factory default setting gain value (L)	—	—	System
+19	CH2 Factory default setting gain value (H)	—	—	System
+20	CH2 User range setting offset value (L)	—	—	System
+21	CH2 User range setting offset value (H)	—	—	System
+22	CH2 User range setting gain value (L)	—	—	System
+23	CH2 User range setting gain value (H)	—	—	System
+24	CH2 User range setting thermoelectromotive force offset value (L)	—	—	System
+25	CH2 User range setting thermoelectromotive force offset value (H)	—	—	System
+26	CH2 User range setting thermoelectromotive force gain value (L)	—	—	System
+27	CH2 User range setting thermoelectromotive force gain value (H)	—	—	System
+28	CH3 Factory default setting offset value (L)	—	—	System
+29	CH3 Factory default setting offset value (H)	—	—	System
+30	CH3 Factory default setting gain value (L)	—	—	System
+31	CH3 Factory default setting gain value (H)	—	—	System
+32	CH3 User range setting offset value (L)	—	—	System
+33	CH3 User range setting offset value (H)	—	—	System
+34	CH3 User range setting gain value (L)	—	—	System
+35	CH3 User range setting gain value (H)	—	—	System
+36	CH3 User range setting thermoelectromotive force offset value (L)	—	—	System
+37	CH3 User range setting thermoelectromotive force offset value (H)	—	—	System
+38	CH3 User range setting thermoelectromotive force gain value (L)	—	—	System
+39	CH3 User range setting thermoelectromotive force gain value (H)	—	—	System

Operand: (s)				
Device	Item	Description	Setting range	Set by
+40	CH4 Factory default setting offset value (L)	—	—	System
+41	CH4 Factory default setting offset value (H)	—	—	System
+42	CH4 Factory default setting gain value (L)	—	—	System
+43	CH4 Factory default setting gain value (H)	—	—	System
+44	CH4 User range setting offset value (L)	—	—	System
+45	CH4 User range setting offset value (H)	—	—	System
+46	CH4 User range setting gain value (L)	—	—	System
+47	CH4 User range setting gain value (H)	—	—	System
+48	CH4 User range setting thermoelectromotive force offset value (L)	—	—	System
+49	CH4 User range setting thermoelectromotive force offset value (H)	—	—	System
+50	CH4 User range setting thermoelectromotive force gain value (L)	—	—	System
+51	CH4 User range setting thermoelectromotive force gain value (H)	—	—	System
+52	CH5 Factory default setting offset value (L)	—	—	System
+53	CH5 Factory default setting offset value (H)	—	—	System
+54	CH5 Factory default setting gain value (L)	—	—	System
+55	CH5 Factory default setting gain value (H)	—	—	System
+56	CH5 User range setting offset value (L)	—	—	System
+57	CH5 User range setting offset value (H)	—	—	System
+58	CH5 User range setting gain value (L)	—	—	System
+59	CH5 User range setting gain value (H)	—	—	System
+60	CH5 User range setting thermoelectromotive force offset value (L)	—	—	System
+61	CH5 User range setting thermoelectromotive force offset value (H)	—	—	System
+62	CH5 User range setting thermoelectromotive force gain value (L)	—	—	System
+63	CH5 User range setting thermoelectromotive force gain value (H)	—	—	System
+64	CH6 Factory default setting offset value (L)	—	—	System
+65	CH6 Factory default setting offset value (H)	—	—	System
+66	CH6 Factory default setting gain value (L)	—	—	System
+67	CH6 Factory default setting gain value (H)	—	—	System
+68	CH6 User range setting offset value (L)	—	—	System
+69	CH6 User range setting offset value (H)	—	—	System
+70	CH6 User range setting gain value (L)	—	—	System
+71	CH6 User range setting gain value (H)	—	—	System
+72	CH6 User range setting thermoelectromotive force offset value (L)	—	—	System
+73	CH6 User range setting thermoelectromotive force offset value (H)	—	—	System
+74	CH6 User range setting thermoelectromotive force gain value (L)	—	—	System
+75	CH6 User range setting thermoelectromotive force gain value (H)	—	—	System
+76	CH7 Factory default setting offset value (L)	—	—	System
+77	CH7 Factory default setting offset value (H)	—	—	System
+78	CH7 Factory default setting gain value (L)	—	—	System
+79	CH7 Factory default setting gain value (H)	—	—	System
+80	CH7 User range setting offset value (L)	—	—	System
+81	CH7 User range setting offset value (H)	—	—	System
+82	CH7 User range setting gain value (L)	—	—	System

Operand: (s)				
Device	Item	Description	Setting range	Set by
+83	CH7 User range setting gain value (H)	—	—	System
+84	CH7 User range setting thermoelectromotive force offset value (L)	—	—	System
+85	CH7 User range setting thermoelectromotive force offset value (H)	—	—	System
+86	CH7 User range setting thermoelectromotive force gain value (L)	—	—	System
+87	CH7 User range setting thermoelectromotive force gain value (H)	—	—	System
+88	CH8 Factory default setting offset value (L)	—	—	System
+89	CH8 Factory default setting offset value (H)	—	—	System
+90	CH8 Factory default setting gain value (L)	—	—	System
+91	CH8 Factory default setting gain value (H)	—	—	System
+92	CH8 User range setting offset value (L)	—	—	System
+93	CH8 User range setting offset value (H)	—	—	System
+94	CH8 User range setting gain value (L)	—	—	System
+95	CH8 User range setting gain value (H)	—	—	System
+96	CH8 User range setting thermoelectromotive force offset value (L)	—	—	System
+97	CH8 User range setting thermoelectromotive force offset value (H)	—	—	System
+98	CH8 User range setting thermoelectromotive force gain value (L)	—	—	System
+99	CH8 User range setting thermoelectromotive force gain value (H)	—	—	System

• For R60RD8-G

Operand: (s)				
Device	Item	Description	Setting range	Set by
+0	System area	—	—	—
+1	Completion status	The instruction completion status is stored. • 0: Completed successfully • Other than 0: Completed with an error (error code)	—	System
+2	System area	—	—	—
+3	System area	—	—	—
+4	CH1 Factory default setting offset value (L)	—	—	System
+5	CH1 Factory default setting offset value (H)	—	—	System
+6	CH1 Factory default setting gain value (L)	—	—	System
+7	CH1 Factory default setting gain value (H)	—	—	System
+8	CH1 User range setting offset value (L)	—	—	System
+9	CH1 User range setting offset value (H)	—	—	System
+10	CH1 User range setting gain value (L)	—	—	System
+11	CH1 User range setting gain value (H)	—	—	System
+12	CH1 User range setting offset resistance value (L)	—	—	System
+13	CH1 User range setting offset resistance value (H)	—	—	System
+14	CH1 User range setting gain resistance value (L)	—	—	System
+15	CH1 User range setting gain resistance value (H)	—	—	System
+16	CH2 Factory default setting offset value (L)	—	—	System
+17	CH2 Factory default setting offset value (H)	—	—	System
+18	CH2 Factory default setting gain value (L)	—	—	System
+19	CH2 Factory default setting gain value (H)	—	—	System
+20	CH2 User range setting offset value (L)	—	—	System
+21	CH2 User range setting offset value (H)	—	—	System
+22	CH2 User range setting gain value (L)	—	—	System
+23	CH2 User range setting gain value (H)	—	—	System
+24	CH2 User range setting offset resistance value (L)	—	—	System
+25	CH2 User range setting offset resistance value (H)	—	—	System
+26	CH2 User range setting gain resistance value (L)	—	—	System
+27	CH2 User range setting gain resistance value (H)	—	—	System
+28	CH3 Factory default setting offset value (L)	—	—	System
+29	CH3 Factory default setting offset value (H)	—	—	System
+30	CH3 Factory default setting gain value (L)	—	—	System
+31	CH3 Factory default setting gain value (H)	—	—	System
+32	CH3 User range setting offset value (L)	—	—	System
+33	CH3 User range setting offset value (H)	—	—	System
+34	CH3 User range setting gain value (L)	—	—	System
+35	CH3 User range setting gain value (H)	—	—	System
+36	CH3 User range setting offset resistance value (L)	—	—	System
+37	CH3 User range setting offset resistance value (H)	—	—	System
+38	CH3 User range setting gain resistance value (L)	—	—	System
+39	CH3 User range setting gain resistance value (H)	—	—	System

Operand: (s)				
Device	Item	Description	Setting range	Set by
+40	CH4 Factory default setting offset value (L)	—	—	System
+41	CH4 Factory default setting offset value (H)	—	—	System
+42	CH4 Factory default setting gain value (L)	—	—	System
+43	CH4 Factory default setting gain value (H)	—	—	System
+44	CH4 User range setting offset value (L)	—	—	System
+45	CH4 User range setting offset value (H)	—	—	System
+46	CH4 User range setting gain value (L)	—	—	System
+47	CH4 User range setting gain value (H)	—	—	System
+48	CH4 User range setting offset resistance value (L)	—	—	System
+49	CH4 User range setting offset resistance value (H)	—	—	System
+50	CH4 User range setting gain resistance value (L)	—	—	System
+51	CH4 User range setting gain resistance value (H)	—	—	System
+52	CH5 Factory default setting offset value (L)	—	—	System
+53	CH5 Factory default setting offset value (H)	—	—	System
+54	CH5 Factory default setting gain value (L)	—	—	System
+55	CH5 Factory default setting gain value (H)	—	—	System
+56	CH5 User range setting offset value (L)	—	—	System
+57	CH5 User range setting offset value (H)	—	—	System
+58	CH5 User range setting gain value (L)	—	—	System
+59	CH5 User range setting gain value (H)	—	—	System
+60	CH5 User range setting offset resistance value (L)	—	—	System
+61	CH5 User range setting offset resistance value (H)	—	—	System
+62	CH5 User range setting gain resistance value (L)	—	—	System
+63	CH5 User range setting gain resistance value (H)	—	—	System
+64	CH6 Factory default setting offset value (L)	—	—	System
+65	CH6 Factory default setting offset value (H)	—	—	System
+66	CH6 Factory default setting gain value (L)	—	—	System
+67	CH6 Factory default setting gain value (H)	—	—	System
+68	CH6 User range setting offset value (L)	—	—	System
+69	CH6 User range setting offset value (H)	—	—	System
+70	CH6 User range setting gain value (L)	—	—	System
+71	CH6 User range setting gain value (H)	—	—	System
+72	CH6 User range setting offset resistance value (L)	—	—	System
+73	CH6 User range setting offset resistance value (H)	—	—	System
+74	CH6 User range setting gain resistance value (L)	—	—	System
+75	CH6 User range setting gain resistance value (H)	—	—	System
+76	CH7 Factory default setting offset value (L)	—	—	System
+77	CH7 Factory default setting offset value (H)	—	—	System
+78	CH7 Factory default setting gain value (L)	—	—	System
+79	CH7 Factory default setting gain value (H)	—	—	System
+80	CH7 User range setting offset value (L)	—	—	System
+81	CH7 User range setting offset value (H)	—	—	System
+82	CH7 User range setting gain value (L)	—	—	System

Operand: (s)				
Device	Item	Description	Setting range	Set by
+83	CH7 User range setting gain value (H)	—	—	System
+84	CH7 User range setting offset resistance value (L)	—	—	System
+85	CH7 User range setting offset resistance value (H)	—	—	System
+86	CH7 User range setting gain resistance value (L)	—	—	System
+87	CH7 User range setting gain resistance value (H)	—	—	System
+88	CH8 Factory default setting offset value (L)	—	—	System
+89	CH8 Factory default setting offset value (H)	—	—	System
+90	CH8 Factory default setting gain value (L)	—	—	System
+91	CH8 Factory default setting gain value (H)	—	—	System
+92	CH8 User range setting offset value (L)	—	—	System
+93	CH8 User range setting offset value (H)	—	—	System
+94	CH8 User range setting gain value (L)	—	—	System
+95	CH8 User range setting gain value (H)	—	—	System
+96	CH8 User range setting offset resistance value (L)	—	—	System
+97	CH8 User range setting offset resistance value (H)	—	—	System
+98	CH8 User range setting gain resistance value (L)	—	—	System
+99	CH8 User range setting gain resistance value (H)	—	—	System

• For R60AD16-G

Operand: (s)					
Device	Item	Description	Setting range	Set by	
+0	System area	—	—	—	
+1	Completion status	The instruction completion status is stored. • 0: Completed successfully • Other than 0: Completed with an error (error code)	—	System	
+2	Save data type setting	Used to store the set value that was set for Save data type setting (s)+2 in the G(P).OGLOAD instruction. • 0: Voltage specification • 1: Current specification b15 b14 b13 b12 b11 b10 b9 b8 b7 b6 b5 b4 b3 b2 b1 b0 CH16 CH15 CH14 CH13 CH12 CH11 CH10 CH9 CH8 CH7 CH6 CH5 CH4 CH3 CH2 CH1	0000H to FFFFH	System	
+3	System area	—	—	—	
+4	CH1 Factory default setting offset value (L)	—	—	System	
+5	CH1 Factory default setting offset value (H)	—	—	System	
+6	CH1 Factory default setting gain value (L)	—	—	System	
+7	CH1 Factory default setting gain value (H)	—	—	System	
+8	CH2 Factory default setting offset value (L)	—	—	System	
+9	CH2 Factory default setting offset value (H)	—	—	System	
+10	CH2 Factory default setting gain value (L)	—	—	System	
+11	CH2 Factory default setting gain value (H)	—	—	System	
+12	CH3 Factory default setting offset value (L)	—	—	System	
+13	CH3 Factory default setting offset value (H)	—	—	System	
+14	CH3 Factory default setting gain value (L)	—	—	System	
+15	CH3 Factory default setting gain value (H)	—	—	System	
+16	CH4 Factory default setting offset value (L)	—	—	System	
+17	CH4 Factory default setting offset value (H)	—	—	System	
+18	CH4 Factory default setting gain value (L)	—	—	System	
+19	CH4 Factory default setting gain value (H)	—	—	System	
+20	CH5 Factory default setting offset value (L)	—	—	System	
+21	CH5 Factory default setting offset value (H)	—	—	System	
+22	CH5 Factory default setting gain value (L)	—	—	System	
+23	CH5 Factory default setting gain value (H)	—	—	System	
+24	CH6 Factory default setting offset value (L)	—	—	System	
+25	CH6 Factory default setting offset value (H)	—	—	System	
+26	CH6 Factory default setting gain value (L)	—	—	System	
+27	CH6 Factory default setting gain value (H)	—	—	System	
+28	CH7 Factory default setting offset value (L)	—	—	System	
+29	CH7 Factory default setting offset value (H)	—	—	System	
+30	CH7 Factory default setting gain value (L)	—	—	System	
+31	CH7 Factory default setting gain value (H)	—	—	System	
+32	CH8 Factory default setting offset value (L)	—	—	System	
+33	CH8 Factory default setting offset value (H)	—	—	System	
+34	CH8 Factory default setting gain value (L)	—	—	System	
+35	CH8 Factory default setting gain value (H)	—	—	System	
+36	CH9 Factory default setting offset value (L)	—	—	System	
+37	CH9 Factory default setting offset value (H)	—	—	System	
+38	CH9 Factory default setting gain value (L)	—	—	System	
+39	CH9 Factory default setting gain value (H)	—	—	System	
+40	CH10 Factory default setting offset value (L)	—	—	System	
+41	CH10 Factory default setting offset value (H)	—	—	System	
+42	CH10 Factory default setting gain value (L)	—	—	System	
+43	CH10 Factory default setting gain value (H)	—	—	System	
+44	CH11 Factory default setting offset value (L)	—	—	System	

Operand: (s)				
Device	Item	Description	Setting range	Set by
+45	CH11	Factory default setting offset value (H)	—	System
+46	CH11	Factory default setting gain value (L)	—	System
+47	CH11	Factory default setting gain value (H)	—	System
+48	CH12	Factory default setting offset value (L)	—	System
+49	CH12	Factory default setting offset value (H)	—	System
+50	CH12	Factory default setting gain value (L)	—	System
+51	CH12	Factory default setting gain value (H)	—	System
+52	CH13	Factory default setting offset value (L)	—	System
+53	CH13	Factory default setting offset value (H)	—	System
+54	CH13	Factory default setting gain value (L)	—	System
+55	CH13	Factory default setting gain value (H)	—	System
+56	CH14	Factory default setting offset value (L)	—	System
+57	CH14	Factory default setting offset value (H)	—	System
+58	CH14	Factory default setting gain value (L)	—	System
+59	CH14	Factory default setting gain value (H)	—	System
+60	CH15	Factory default setting offset value (L)	—	System
+61	CH15	Factory default setting offset value (H)	—	System
+62	CH15	Factory default setting gain value (L)	—	System
+63	CH15	Factory default setting gain value (H)	—	System
+64	CH16	Factory default setting offset value (L)	—	System
+65	CH16	Factory default setting offset value (H)	—	System
+66	CH16	Factory default setting gain value (L)	—	System
+67	CH16	Factory default setting gain value (H)	—	System
+68	CH1	User range setting offset value (L)	—	System
+69	CH1	User range setting offset value (H)	—	System
+70	CH1	User range setting gain value (L)	—	System
+71	CH1	User range setting gain value (H)	—	System
+72	CH2	User range setting offset value (L)	—	System
+73	CH2	User range setting offset value (H)	—	System
+74	CH2	User range setting gain value (L)	—	System
+75	CH2	User range setting gain value (H)	—	System
+76	CH3	User range setting offset value (L)	—	System
+77	CH3	User range setting offset value (H)	—	System
+78	CH3	User range setting gain value (L)	—	System
+79	CH3	User range setting gain value (H)	—	System
+80	CH4	User range setting offset value (L)	—	System
+81	CH4	User range setting offset value (H)	—	System
+82	CH4	User range setting gain value (L)	—	System
+83	CH4	User range setting gain value (H)	—	System
+84	CH5	User range setting offset value (L)	—	System
+85	CH5	User range setting offset value (H)	—	System
+86	CH5	User range setting gain value (L)	—	System
+87	CH5	User range setting gain value (H)	—	System
+88	CH6	User range setting offset value (L)	—	System
+89	CH6	User range setting offset value (H)	—	System
+90	CH6	User range setting gain value (L)	—	System
+91	CH6	User range setting gain value (H)	—	System
+92	CH7	User range setting offset value (L)	—	System
+93	CH7	User range setting offset value (H)	—	System
+94	CH7	User range setting gain value (L)	—	System
+95	CH7	User range setting gain value (H)	—	System
+96	CH8	User range setting offset value (L)	—	System

Operand: (s)				
Device	Item	Description	Setting range	Set by
+97	CH8	User range setting offset value (H)	—	System
+98	CH8	User range setting gain value (L)	—	System
+99	CH8	User range setting gain value (H)	—	System
+100	CH9	User range setting offset value (L)	—	System
+101	CH9	User range setting offset value (H)	—	System
+102	CH9	User range setting gain value (L)	—	System
+103	CH9	User range setting gain value (H)	—	System
+104	CH10	User range setting offset value (L)	—	System
+105	CH10	User range setting offset value (H)	—	System
+106	CH10	User range setting gain value (L)	—	System
+107	CH10	User range setting gain value (H)	—	System
+108	CH11	User range setting offset value (L)	—	System
+109	CH11	User range setting offset value (H)	—	System
+110	CH11	User range setting gain value (L)	—	System
+111	CH11	User range setting gain value (H)	—	System
+112	CH12	User range setting offset value (L)	—	System
+113	CH12	User range setting offset value (H)	—	System
+114	CH12	User range setting gain value (L)	—	System
+115	CH12	User range setting gain value (H)	—	System
+116	CH13	User range setting offset value (L)	—	System
+117	CH13	User range setting offset value (H)	—	System
+118	CH13	User range setting gain value (L)	—	System
+119	CH13	User range setting gain value (H)	—	System
+120	CH14	User range setting offset value (L)	—	System
+121	CH14	User range setting offset value (H)	—	System
+122	CH14	User range setting gain value (L)	—	System
+123	CH14	User range setting gain value (H)	—	System
+124	CH15	User range setting offset value (L)	—	System
+125	CH15	User range setting offset value (H)	—	System
+126	CH15	User range setting gain value (L)	—	System
+127	CH15	User range setting gain value (H)	—	System
+128	CH16	User range setting offset value (L)	—	System
+129	CH16	User range setting offset value (H)	—	System
+130	CH16	User range setting gain value (L)	—	System
+131	CH16	User range setting gain value (H)	—	System

• For R60DA16-G

Operand: (s)																																				
Device	Item	Description	Setting range	Set by																																
+0	System area	—	—	—																																
+1	Completion status	The instruction completion status is stored. • 0: Completed successfully • Other than 0: Completed with an error (error code)	—	System																																
+2	Save data type setting 1	Used to store the set value that was set for Save data type setting 1 (s)+2 in the G(P).OGLOAD instruction. • 0H: User range setting 1 (current specification) • 1H: User range setting 2 (voltage specification) • 2H: User range setting 3 (voltage specification) <table border="1" style="width: 100%; border-collapse: collapse;"> <tr> <td>b15</td><td>b14</td><td>b13</td><td>b12</td><td>b11</td><td>b10</td><td>b9</td><td>b8</td><td>b7</td><td>b6</td><td>b5</td><td>b4</td><td>b3</td><td>b2</td><td>b1</td><td>b0</td> </tr> <tr> <td>CH8</td><td>CH7</td><td>CH6</td><td>CH5</td><td>CH4</td><td>CH3</td><td>CH2</td><td>CH1</td><td colspan="8"></td> </tr> </table>	b15	b14	b13	b12	b11	b10	b9	b8	b7	b6	b5	b4	b3	b2	b1	b0	CH8	CH7	CH6	CH5	CH4	CH3	CH2	CH1									0000H to AAAAH	System
b15	b14	b13	b12	b11	b10	b9	b8	b7	b6	b5	b4	b3	b2	b1	b0																					
CH8	CH7	CH6	CH5	CH4	CH3	CH2	CH1																													
+3	Save data type setting 2	Used to store the set value that was set for Save data type setting 2 (s)+3 in the G(P).OGLOAD instruction. • 0H: User range setting 1 (current specification) • 1H: User range setting 2 (voltage specification) • 2H: User range setting 3 (voltage specification) <table border="1" style="width: 100%; border-collapse: collapse;"> <tr> <td>b15</td><td>b14</td><td>b13</td><td>b12</td><td>b11</td><td>b10</td><td>b9</td><td>b8</td><td>b7</td><td>b6</td><td>b5</td><td>b4</td><td>b3</td><td>b2</td><td>b1</td><td>b0</td> </tr> <tr> <td>CH16</td><td>CH15</td><td>CH14</td><td>CH13</td><td>CH12</td><td>CH11</td><td>CH10</td><td>CH9</td><td colspan="8"></td> </tr> </table>	b15	b14	b13	b12	b11	b10	b9	b8	b7	b6	b5	b4	b3	b2	b1	b0	CH16	CH15	CH14	CH13	CH12	CH11	CH10	CH9									0000H to AAAAH	System
b15	b14	b13	b12	b11	b10	b9	b8	b7	b6	b5	b4	b3	b2	b1	b0																					
CH16	CH15	CH14	CH13	CH12	CH11	CH10	CH9																													
+4	CH1 Factory default setting offset value	—	—	System																																
+5	CH1 Factory default setting gain value	—	—	System																																
+6	CH2 Factory default setting offset value	—	—	System																																
+7	CH2 Factory default setting gain value	—	—	System																																
+8	CH3 Factory default setting offset value	—	—	System																																
+9	CH3 Factory default setting gain value	—	—	System																																
+10	CH4 Factory default setting offset value	—	—	System																																
+11	CH4 Factory default setting gain value	—	—	System																																
+12	CH5 Factory default setting offset value	—	—	System																																
+13	CH5 Factory default setting gain value	—	—	System																																
+14	CH6 Factory default setting offset value	—	—	System																																
+15	CH6 Factory default setting gain value	—	—	System																																
+16	CH7 Factory default setting offset value	—	—	System																																
+17	CH7 Factory default setting gain value	—	—	System																																
+18	CH8 Factory default setting offset value	—	—	System																																
+19	CH8 Factory default setting gain value	—	—	System																																
+20	CH9 Factory default setting offset value	—	—	System																																
+21	CH9 Factory default setting gain value	—	—	System																																
+22	CH10 Factory default setting offset value	—	—	System																																
+23	CH10 Factory default setting gain value	—	—	System																																
+24	CH11 Factory default setting offset value	—	—	System																																
+25	CH11 Factory default setting gain value	—	—	System																																
+26	CH12 Factory default setting offset value	—	—	System																																
+27	CH12 Factory default setting gain value	—	—	System																																
+28	CH13 Factory default setting offset value	—	—	System																																
+29	CH13 Factory default setting gain value	—	—	System																																
+30	CH14 Factory default setting offset value	—	—	System																																
+31	CH14 Factory default setting gain value	—	—	System																																
+32	CH15 Factory default setting offset value	—	—	System																																
+33	CH15 Factory default setting gain value	—	—	System																																
+34	CH16 Factory default setting offset value	—	—	System																																
+35	CH16 Factory default setting gain value	—	—	System																																
+36	CH1 User range setting offset value	—	—	System																																
+37	CH1 User range setting gain value	—	—	System																																
+38	CH2 User range setting offset value	—	—	System																																

Operand: (s)				
Device	Item	Description	Setting range	Set by
+39	CH2 User range setting gain value	—	—	System
+40	CH3 User range setting offset value	—	—	System
+41	CH3 User range setting gain value	—	—	System
+42	CH4 User range setting offset value	—	—	System
+43	CH4 User range setting gain value	—	—	System
+44	CH5 User range setting offset value	—	—	System
+45	CH5 User range setting gain value	—	—	System
+46	CH6 User range setting offset value	—	—	System
+47	CH6 User range setting gain value	—	—	System
+48	CH7 User range setting offset value	—	—	System
+49	CH7 User range setting gain value	—	—	System
+50	CH8 User range setting offset value	—	—	System
+51	CH8 User range setting gain value	—	—	System
+52	CH9 User range setting offset value	—	—	System
+53	CH9 User range setting gain value	—	—	System
+54	CH10 User range setting offset value	—	—	System
+55	CH10 User range setting gain value	—	—	System
+56	CH11 User range setting offset value	—	—	System
+57	CH11 User range setting gain value	—	—	System
+58	CH12 User range setting offset value	—	—	System
+59	CH12 User range setting gain value	—	—	System
+60	CH13 User range setting offset value	—	—	System
+61	CH13 User range setting gain value	—	—	System
+62	CH14 User range setting offset value	—	—	System
+63	CH14 User range setting gain value	—	—	System
+64	CH15 User range setting offset value	—	—	System
+65	CH15 User range setting gain value	—	—	System
+66	CH16 User range setting offset value	—	—	System
+67	CH16 User range setting gain value	—	—	System
+68	System area	—	—	—

Processing details

- These instructions restore the offset/gain settings in the user range setting stored in a CPU module into an analog module.
- Execution and normal/error completion of the G(P).OGSTOR instruction can be checked with the completion device specified by the setting data (d) and the completion status indication device (d)+1.

- Completion device (d)

Turns on during END processing of the scan that arises upon completion of the G(P).OGSTOR instruction, and turns off during the next END processing.

- Completion status indication device (d)+1

Turns on or off depending on the status resulting from completion of the G(P).OGSTOR instruction.

When completed normally: Unchanged from off.

When completed with an error: Turns on during END processing of the scan that arises upon completion of the G(P).OGSTOR instruction, and turns off during the next END processing.

- The following figure shows the operation at the completion of the G(P).OGSTOR instruction.

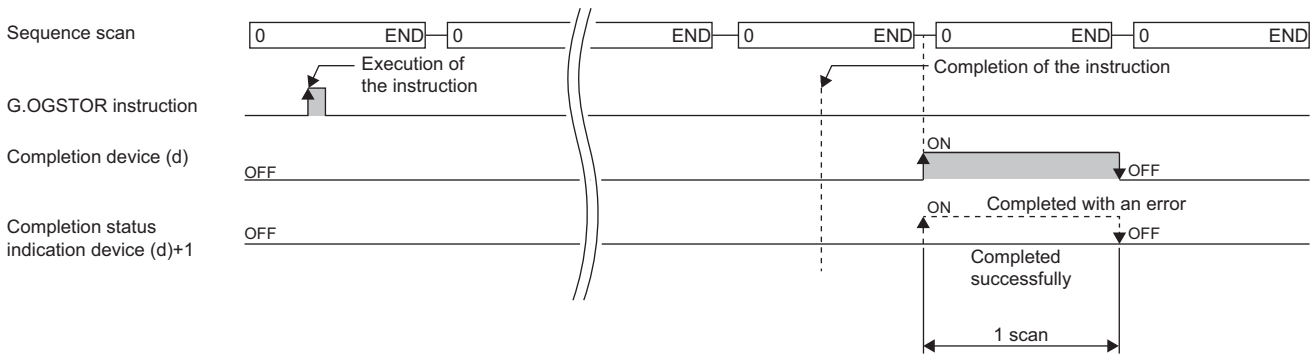

- After the offset/gain setting value has been restored, the base rate decreases to about three times or more of the unrestored accuracy.

Point

When the G(P).OGSTOR instruction is executed, the D/A converter module stops the D/A conversion. To resume the D/A conversion, turn on and off the operating condition setting request (Y9).

Program example

The following figure shows an example of a program which uses the G(P).OGSTOR instruction with the R60AD4.

- Program content

Description

When "Dedicated Instruction Execution Request" (M11) is turned off, the offset/gain settings are restored in the analog module mounted at the position of I/O numbers X/Y10 to X/Y1F.

- Label setting

Classification	Label name	Description	Device
Module label	—	—	—
Label to be defined	Define the global label as shown below.		
	Label Name	Data Type	Class Assign (Device/Label)
	G_bOgStartReq	Bit	VAR_GLOBAL M11
	G_bReadStart	Bit	VAR_GLOBAL M12
	G_bWriteStart	Bit	VAR_GLOBAL M13
	G_bnOgLoadCmpFlg	Bit(0..1)	VAR_GLOBAL M20
	G_bnOgStorCmpFlg	Bit(0..1)	VAR_GLOBAL M30
	G_wCtrlDataTopDev	Word [Signed]	VAR_GLOBAL D100
	G_uSaveData Type	Word [Unsigned]/Bit String [16-bit]	VAR_GLOBAL D102
	G_bReadAbnormalComplete	Bit	VAR_GLOBAL F0
	G_bWriteAbnormalComplete	Bit	VAR_GLOBAL F1

• Program example

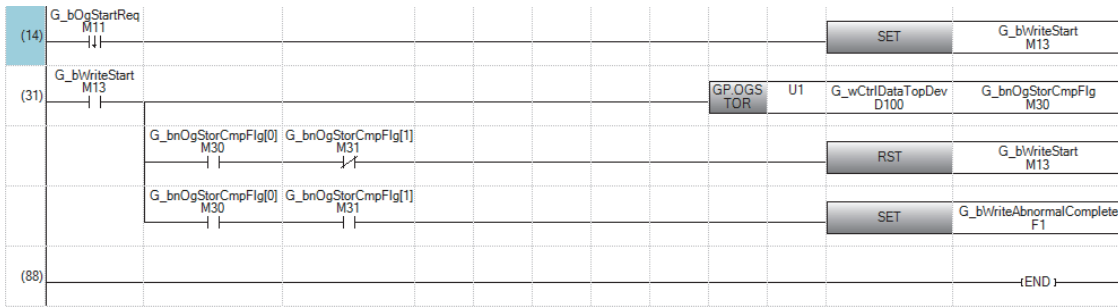

- (14) Set control data.
- (31) Restore the offset/gain settings.

Precautions

In the following cases, execution of the G(P).OGSTOR instruction results in an error.

- The module has been set as a target of synchronization.
- The normal mode (high speed: 1μs/CH) or simultaneous conversion mode has been selected on the high speed analog-digital converter module.
- The wave output mode has been selected on the D/A converter module.

In the following case, execution of the G(P).OGSTOR instruction will be disabled.

- The high-speed output mode has been selected on the high speed digital-analog converter module.

Operation error

Error code ((s)+1)	Description
1860H	In the following cases, the G(P).OGSTOR instruction will be being executed. <ul style="list-style-type: none"> • During offset/gain setting module • Has been set as a target of module-to-module synchronization. • During normal mode (high speed: 1μs/CH) (R60ADH4) • During simultaneous conversion mode (R60ADH4) • During wave output mode (D/A converter module)
1861H	The G(P).OGSTOR instruction is being executed consecutively.
1862H	The G(P).OGSTOR instruction is being executed for a model different from that for which the G(P).OGLOAD instruction has been executed. The G(P).OGSTOR instruction is being executed before the G(P).OGLOAD instruction is executed.
1863H	The value set in the save data type setting 1 (s)+2 or the save data type setting 2 (s)+3 is out of the valid range.

11 POSITIONING INSTRUCTIONS

Point

This chapter describes the instructions used commonly by MELSEC iQ-R series modules. When using MELSEC-Q series modules, refer to the manual for each module used and create programs. For precautions when using modules, refer to the following.

 MELSEC iQ-R Module Configuration Manual

11.1 Restoring the Absolute Position

G.ABRST□, Z.ABRST□

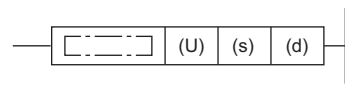

These instructions restore the absolute position of specified axis.

Ladder	ST
	<pre> ENO:=G_ABRST1(EN,U,s,d); ENO:=G_ABRST2(EN,U,s,d); ENO:=G_ABRST3(EN,U,s,d); ENO:=G_ABRST4(EN,U,s,d); ENO:=Z_ABRST1(EN,U,s,d); ENO:=Z_ABRST2(EN,U,s,d); ENO:=Z_ABRST3(EN,U,s,d); ENO:=Z_ABRST4(EN,U,s,d); </pre>

FBD/LD

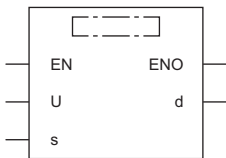

Execution condition

Instruction	Execution condition
G.ABRST1 G.ABRST2 G.ABRST3 G.ABRST4 Z.ABRST1 Z.ABRST2 Z.ABRST3 Z.ABRST4	

Setting data

■Description, range, data type

Operand	Description	Range	Data type	Data type (label)	
(U)	G.ABRST□	Start I/O number (first three digits in four-digit hexadecimal representation) of a module	00H to FEH	16-bit unsigned binary	ANY16
	Z.ABRST□	Start I/O number (first three digits in four-digit hexadecimal representation) of a module	00H to FEH	String	ANY16_OR_STRING_SINGLE
(s)		Start device where the control data is stored	Refer to the control data.	Device name	ANY16*1
(d)		Device that turns on for one scan upon completion of the instruction If the instruction is completed with an error, (d)+1 is also turned on.	—	Bit	ANYBIT_ARRAY (Number of elements: 2)
EN		Execution condition	—	Bit	BOOL
ENO		Execution result	—	Bit	BOOL

*1 When specifying setting data by using a label, define an array to secure enough operation area and specify an element of the array label.

■Applicable devices

Operand	Bit X, Y, M, L, SM, F, B, SB, FX, FY	J□□□	Word T, ST, C, D, W, SD, SW, FD, R, ZR, RD	U□□G□, J□□□, U3E□□(H)G□	Z	Double word		Indirect specification	Constant			Others (U)
						LT, LST, LC	LZ		K, H	E	\$	
(U)	G.ABRST□	—	○	—	—	—	—	○	○	—	—	○
	Z.ABRST□	—	○	—	—	—	—	○	—	—	○	○
(s)	—	—	○*3	—	—	—	—	○	—	—	—	—
(d)	○*1	—	○*2	—	—	—	—	—	—	—	—	—

*1 FX and FY cannot be used.

*2 T, ST, C, and FD cannot be used.

*3 FD cannot be used.

■Control data

Operand: (s)				
Device	Item	Description	Setting range	Set by
+0	System area	—	—	—
+1	Completion status	The instruction completion status is stored. • 0: Completed successfully • Other than 0: Completed with an error (error code)	—	System
+2	Signal received from the servo amplifier	Write the signal status, below, imported from the servo amplifier to the input module. • b0: ABS data bit 0 • b1: ABS data bit 1 • b2: Send data ready flag	0, 1	User
+3	Signal to be sent to the servo amplifier	Performs the operation with the dedicated instruction by using the "Signal received from the servo amplifier" in (s)+2. The ON/OFF state of the following data, output to the servo amplifier, is stored. • b0: Servo on • b1: ABS transfer mode • b2: ABS request flag	—	System
+4	Status	Status of communication with the servo amplifier • 0: Communication complete (set by the user at start of communication) • Other than 0: Now communicating (stored by the system)	0	User/ system
+5 to +7	System area	—	—	—

Processing details

- The positioning data is read from the servo amplifier corresponding to the absolute position along the following target axis, and the value with the unit converted is stored in the "Current read value" and "Machine feed value" areas in the positioning module. For the absolute position detection system, restore the absolute position once when it is powered on or the CPU module is reset.

Instruction symbol	Target axis
G.ABRST1, Z.ABRST1	Axis 1
G.ABRST2, Z.ABRST2	Axis 2
G.ABRST3, Z.ABRST3	Axis 3
G.ABRST4, Z.ABRST4	Axis 4

- The following figure shows how the ABRST□ instruction operates.

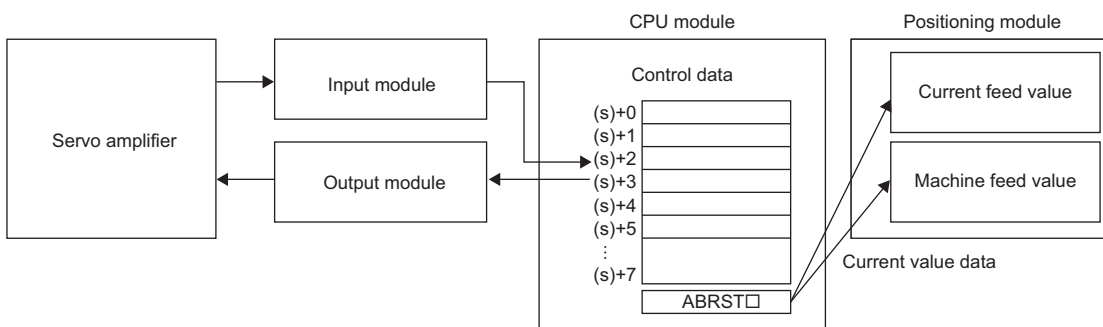

- For communication with the servo amplifier corresponding to the absolute position (data read/write), the I/O module is used. To use the ABRST□ instruction, prepare I/O modules having the following number of points to communicate with servo amplifier per axis.
 - Input: 3 points
 - Output: 3 points
- The execution of the ABRST□ instruction and whether it has been completed normally or with an error can be checked with the completion device (d) or completion status indication device (d)+1.

- Completion device (d)

This device turns on during the END processing of the scan where the ABRST□ instruction completed, and turns off during the next END processing.

- Completion status indication device (d)+1

This device turns on or off depending on the completion status of the ABRST□ instruction.

When completed normally: Unchanged from off.

When completed with an error: Turns on during the END processing of the scan where the ABRST□ instruction completed, and turns off during the next END processing (the same on/off operation as the completion device is performed).

- The following figure shows the operation at completion of the ABRST□ instruction.

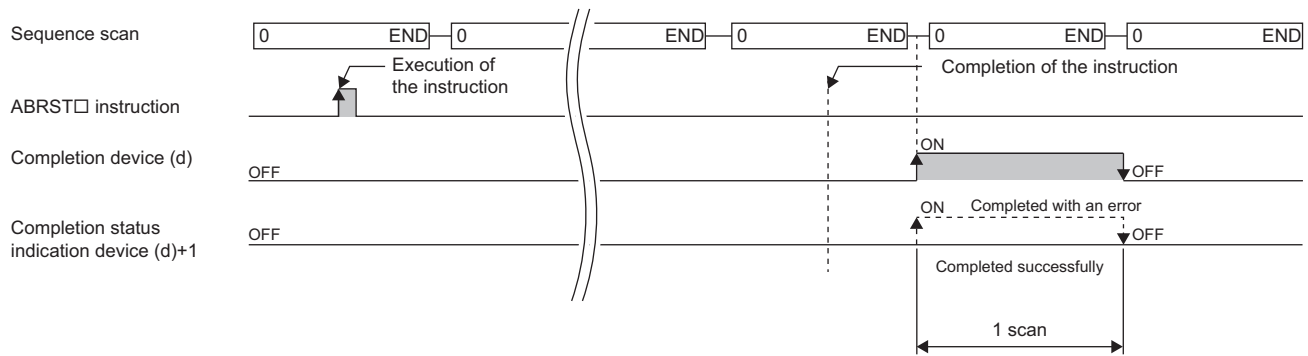

- Completion of absolute position restoration can be checked with the (s)+4 status.
- The ABRST□ instruction performs absolute position restoration by following procedure.

1. Output data from ((s)+3).

Servo on, ABS transfer mode, and ABS request flag are output to the output module by using the program.

2. Set data in ((s)+2).

ABS data bit 0/bit 1 and the send data ready flag are set using the program.

3. Execute the ABRST□ instruction.

4. Check whether the value in ((s)+4) is 0 or not.

When the value is other than 0, the processing returns to step 1.

When the value is 0, the processing ends.

Precautions

- If the absolute position detection system has been constructed, absolute position restoration must be performed once after the power is turned on or reset. The servo does not turn on until the absolute position restoration completes with the positioning module.
- Absolute position restoration must be performed while the programmable controller ready signal [Y0] is off.
- The absolute position can be restored (the ABRST□ instruction can be executed) while a servo amplifier is operable. Note that when the absolute position is restored, the Servo on signal may turn off (servo off) during the period of the scan time plus approximately 60ms and the module may operate. To restore the absolute position during the servo off state, install an electromagnetic brake separately so that signals are output to the electromagnetic brake while the ABRST□ instruction is being executed.
- The following instructions cannot be executed simultaneously to a single axis. For different axes, any of the following can be executed concurrently with a G.ABRST instruction.
 - Positioning start instruction (PSTRT□)
 - Absolute position restoration instruction (ABRST□)
 - Teaching instruction (TEACH□)

Operation error

Error code ((s)+1)	Description
1860H	A value other than 0 was set in "Status" of (s)+4 (at start of communication with the servo amplifier).
1861H	"Status" of (s)+4 was changed during absolute position restoration (i.e. during communication with the servo amplifier).
1865H	An instruction was specified for an undefined axis (e.g. the G.ABRST3 instruction was specified when RD75P2 is used).

11.2 Starting the Positioning

GP.PSTRTO, ZP.PSTRTO

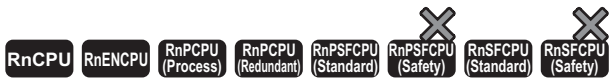

These instructions start to position the specified axis.

Ladder	ST
	<pre> ENO:=GP_PSTRT1(EN,U,s,d); ENO:=GP_PSTRT2(EN,U,s,d); ENO:=GP_PSTRT3(EN,U,s,d); ENO:=GP_PSTRT4(EN,U,s,d); ENO:=ZP_PSTRT1(EN,U,s,d); ENO:=ZP_PSTRT2(EN,U,s,d); ENO:=ZP_PSTRT3(EN,U,s,d); ENO:=ZP_PSTRT4(EN,U,s,d); </pre>

FBD/LD

Execution condition

Instruction	Execution condition
GP.PSTRT1 GP.PSTRT2 GP.PSTRT3 GP.PSTRT4 ZP.PSTRT1 ZP.PSTRT2 ZP.PSTRT3 ZP.PSTRT4	

Setting data

Description, range, data type

Operand	Description	Range	Data type	Data type (label)
(U)	GP.PSTRTO Start I/O number (first three digits in four-digit hexadecimal representation) of a module	00H to FEH	16-bit unsigned binary	ANY16
	ZP.PSTRTO Start I/O number (first three digits in four-digit hexadecimal representation) of a module	00H to FEH	String	ANY16_OR_STRING_SINGLE
(s)	Start device where the control data is stored	Refer to the control data.	Device name	ANY16*1
(d)	Device that turns on for one scan upon completion of the instruction If the instruction is completed with an error, (d)+1 is also turned on.	—	Bit	ANYBIT_ARRAY (Number of elements: 2)
EN	Execution condition	—	Bit	BOOL
ENO	Execution result	—	Bit	BOOL

*1 When specifying setting data by using a label, define an array to secure enough operation area and specify an element of the array label.

■Applicable devices

Operand	Bit		Word			Double word		Indirect specification	Constant			Others (U)
	X, Y, M, L, SM, F, B, SB, FX, FY	J□□	T, ST, C, D, W, SD, SW, FD, R, ZR, RD	U□\G□, J□□, U3E□(H)G□	Z	LT, LST, LC	LZ		K, H, E, \$			
(U)	GP.PSTR□	—	—	○	—	—	—	○	○	—	—	○
	ZP.PSTR□	—	—	○	—	—	—	○	—	—	○	○
(s)		—	—	○ ^{*3}	—	—	—	○	—	—	—	—
(d)		○ ^{*1}	—	○ ^{*2}	—	—	—	—	—	—	—	—

*1 FX and FY cannot be used.

*2 T, ST, C, and FD cannot be used.

*3 FD cannot be used.

■Control data

Operand: (s)				
Device	Item	Description	Setting range	Set by
+0	System area	—	—	—
+1	Completion status	The instruction completion status is stored. • 0: Completed successfully • Other than 0: Completed with an error (error code)	—	System
+2	Start number	Specifies the number of the following data that is started with the PSTR□ instruction. • Positioning data number: 1 to 600 • Block start: 7000 to 7004 • Machine OPR: 9001 • Fast OPR: 9002 • Present value change: 9003 • Multiple axes concurrent start: 9004	1 to 600 7000 to 7004 9001 to 9004	User

Processing details

- The positioning is started for the specified axes below.

Instruction symbol	Target axis
GP.PSTR1, ZP.PSTR1	Axis 1
GP.PSTR2, ZP.PSTR2	Axis 2
GP.PSTR3, ZP.PSTR3	Axis 3
GP.PSTR4, ZP.PSTR4	Axis 4

- Block start, origin return start, present value change start, and multiple axes concurrent start are available by specifying one of 7000 to 7004 or 9001 to 9004 with "Start number" in (s)+2.
- The execution of the PSTR□ instruction and whether it has been completed normally or with an error can be checked with the completion device (d) or completion status indication device (d)+1.

- Completion device (d)

This device turns on during the END processing of the scan where the PSTR□ instruction completed, and turns off during the next END processing.

- Completion status indication device (d)+1

This device turns on or off depending on the completion status of the PSTR□ instruction.

When completed normally: Unchanged from off.

When completed with an error: Turns on during the END processing of the scan where the PSTR□ instruction completed, and turns off during the next END processing (the same on/off operation as the completion device is performed).

- The following figure shows the operation at completion of the PSTRT□ instruction.

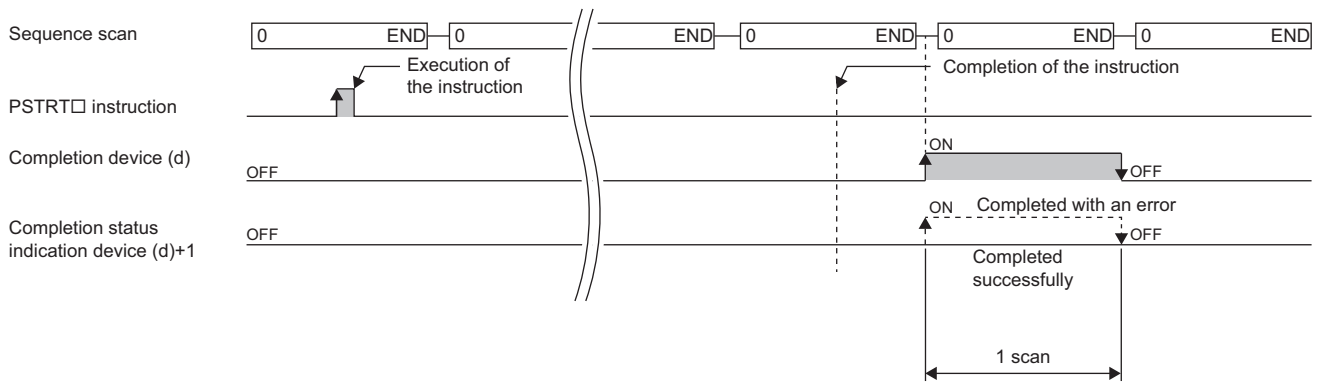

Precautions

- If the positioning is started by using the PSTRT□ instruction, the Position start signal [Y10, Y11, Y12, Y13] will not turn on. In this case, although the start completion signals [X10, X11, X12, X13] turn on, the ON time is short; the program may fail to detect the ON state. For this reason, start completion cannot be checked using the start completion signals [X10, X11, X12, X13]. Check the positioning control status with the start command of the PSTRT□ instruction or the BUSY signal [XC, XD, XE, XF].
- If the positioning is started by using the PSTRT□ instruction, and then the stop command is input before the positioning completes, the completion device (d) turns on for one scan and the execution of the PSTRT□ instruction completes.
- The following instructions cannot be executed simultaneously to a single axis. For different axes, any of the following can be executed concurrently with a G.ABRST instruction.
 - Positioning start instruction (PSTRT□)
 - Absolute position restoration instruction (ABRST□)
 - Teaching instruction (TEACH□)
- The PSTRT□ instruction is executed when the RD75 READY signal [X0] is on. While the RD75 READY signal [X0] is off, the instruction cannot be executed even though it is requested. (No processing is performed.) Before executing the instruction, turn on both the PLC READY signal [Y0] and the RD75 READY signal [X0].
- If multiple axes concurrent start is executed using the PSTRT□ instruction, the completion device (d) turns on when the positioning completes for the axis where the PSTRT□ instruction has been executed (e.g. Axis 1 for GP.PSTRT1).
- If the PSTRT□ instruction is used, the starting time will delay 0 to 0.88ms relative to the Positioning start signal [Y10, Y11, Y12, Y13].

Operation error

Error code ((s)+1)	Description
1862H	A value other than 1 to 600, 7000 to 7004, or 9001 to 9004 was set in "Starting number" of (s)+2.
1865H	An instruction was specified for an undefined axis (e.g. the GP.PSTRT3 instruction was specified when RD75P2 is used).

11.3 Teaching

GP.TEACH□, ZP.TEACH□

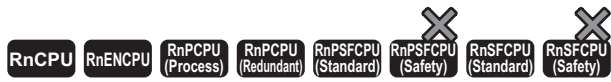

These instructions perform teaching for the specified axis.

Ladder	ST
	<pre> ENO:=GP_TEACH1(EN,U,s,d); ENO:=GP_TEACH2(EN,U,s,d); ENO:=GP_TEACH3(EN,U,s,d); ENO:=GP_TEACH4(EN,U,s,d); ENO:=ZP_TEACH1(EN,U,s,d); ENO:=ZP_TEACH2(EN,U,s,d); ENO:=ZP_TEACH3(EN,U,s,d); ENO:=ZP_TEACH4(EN,U,s,d); </pre>

FBD/LD

Execution condition

Instruction	Execution condition
GP.TEACH1 GP.TEACH2 GP.TEACH3 GP.TEACH4 ZP.TEACH1 ZP.TEACH2 ZP.TEACH3 ZP.TEACH4	

Setting data

Description, range, data type

Operand	Description	Range	Data type	Data type (label)
(U)	GP.TEACH□ Start I/O number (first three digits in four-digit hexadecimal representation) of a module	00H to FEH	16-bit unsigned binary	ANY16
	ZP.TEACH□ Start I/O number (first three digits in four-digit hexadecimal representation) of a module	00H to FEH	String	ANY16_OR_STRING_SINGLE
(s)	Start device where the control data is stored	Refer to the control data.	Device name	ANY16 ^{*1}
(d)	Device that turns on for one scan upon completion of the instruction If the instruction is completed with an error, (d)+1 is also turned on.	—	Bit	ANYBIT_ARRAY (Number of elements: 2)
EN	Execution condition	—	Bit	BOOL
ENO	Execution result	—	Bit	BOOL

*1 When specifying setting data by using a label, define an array to secure enough operation area and specify an element of the array label.

■Applicable devices

Operand		Bit		Word			Double word		Indirect specification	Constant			Others
		X, Y, M, L, SM, F, B, SB, FX, FY	J□□	T, ST, C, D, W, SD, SW, FD, R, ZR, RD	U□\G□, J□□, U3E□\(\H)G□	Z	LT, LST, LC	LZ		K, H	E	\$	
(U)	GP.TEACH□	—	—	○	—	—	—	○	○	—	—	○	
	ZP.TEACH□	—	—	○	—	—	—	○	—	—	○	○	
(s)		—	—	○ ^{*3}	—	—	—	○	—	—	—	—	
(d)		○ ^{*1}	—	○ ^{*2}	—	—	—	—	—	—	—	—	

*1 FX and FY cannot be used.

*2 T, ST, C, and FD cannot be used.

*3 FD cannot be used.

■Control data

Operand: (s)				
Device	Item	Description	Setting range	Set by
+0	System area	—	—	—
+1	Completion status	The instruction completion status is stored. • 0: Completed successfully • Other than 0: Completed with an error (error code)	—	System
+2	Teaching data selection	Selects the address where to write the current feed value (positioning or arc address). • 0: Writes the current feed value to the positioning address. • 1: Writes the current feed value to the arc address.	0, 1	User
+3	Positioning data number	Sets the positioning data number at which to perform the teaching.	1 to 600	User

Processing details

- The data of "[Md.20] Current feed value" of one of the following target axes is set in the positioning or arc address. The positioning data other than the positioning or arc address must be set using the engineering tool or program.

Instruction symbol	Target axis
GP.TEACH1, ZP.TEACH1	Axis 1
GP.TEACH2, ZP.TEACH2	Axis 2
GP.TEACH3, ZP.TEACH3	Axis 3
GP.TEACH4, ZP.TEACH4	Axis 4

- Positioning data No.1 to 600 can be taught.
- To move to an address (position) to be set as the positioning or arc address of the positioning data, JOG, inching, or manual pulse operation is used.
- The execution of the TEACH□ instruction and whether it has been completed normally or with an error can be checked with the completion device (d) or completion status indication device (d)+1.

- Completion device (d)

This device turns on during the END processing of the scan where the TEACH□ instruction completed, and turns off during the next END processing.

- Completion status indication device (d)+1

This device turns on or off depending on the completion status of the TEACH□ instruction.

When completed normally: Unchanged from off.

When completed with an error: Turns on during the END processing of the scan where the TEACH□ instruction completed, and turns off during the next END processing (the same on/off operation as the completion device is performed).

- The following figure shows the operation at completion of the TEACH□ instruction.

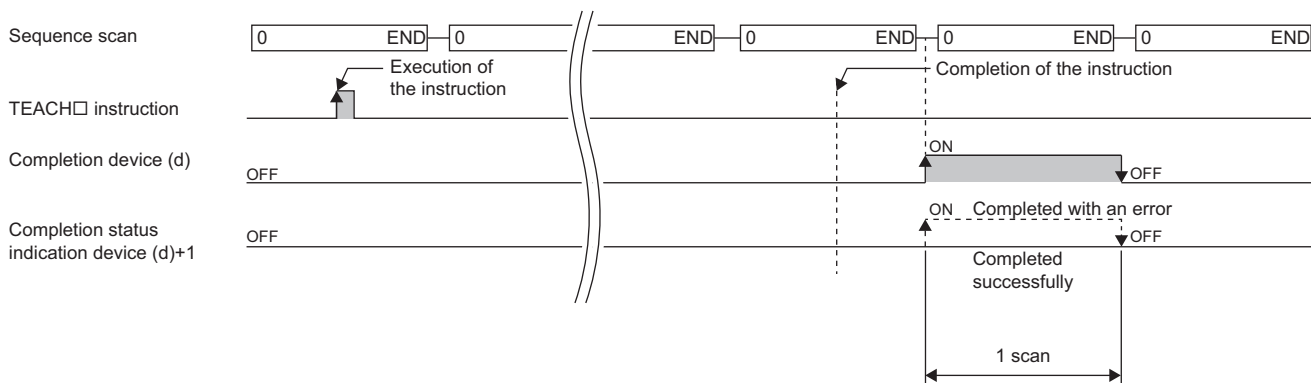

Precautions

- For a single axis, any of the following instructions cannot be executed concurrently with a G.ABRST instruction. although different axes, any of the following can be executed concurrently with a GP.TEACH instruction.
 - Positioning start instruction (PSTR□)
 - Absolute position restoration instruction (ABRST□)
 - Teaching instruction (TEACH□)
- The TEACH□ instruction is executed when the BUSY signal [XC, XD, XE, or XF] is off. While the BUSY signal [XC, XD, XE, XF] is on, the instruction cannot be executed. (No processing is performed.) Before executing the instruction, check that the BUSY signal [XC, XD, XE, XF] of the corresponding axis is off.

Operation error

Error code ((s)+1)	Description
1863H	A value other than 0 or 1 was set in "Teaching data selection" of (s)+2.
1864H	A value other than 1 to 600 was set in "Positioning data number" of (s)+3
1865H	An instruction was specified for an undefined axis (e.g. the GP.TEACH3 instruction was specified when RD75P2 is used).

11.4 Backing up Module Data (Writing Data to the Flash ROM)

GP.PFWRT, ZP.PFWRT

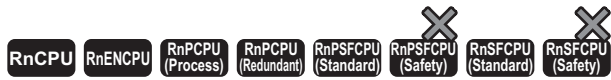

These instructions write the module extension parameters (positioning data and block start data) in the buffer memory to the module extension parameter file.

Ladder	ST
	<pre>ENO:=GP_PFWRT(EN,U,s,d); ENO:=ZP_PFWRT(EN,U,s,d);</pre>

FBD/LD

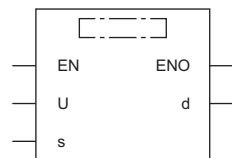

Execution condition

Instruction	Execution condition
GP.PFWRT ZP.PFWRT	

Setting data

Description, range, data type

Operand	Description	Range	Data type	Data type (label)
(U)	GP.PFWRT Start I/O number (first three digits in four-digit hexadecimal representation) of a module	00H to FEH	16-bit unsigned binary	ANY16
	ZP.PFWRT Start I/O number (first three digits in four-digit hexadecimal representation) of a module	00H to FEH	String	ANY16_OR_STRING_SINGLE
(s)	Start device where the control data is stored	Refer to the control data.	Device name	ANY16 ^{*1}
(d)	Device that turns on for one scan upon completion of the instruction If the instruction is completed with an error, (d)+1 is also turned on.	—	Bit	ANYBIT_ARRAY (Number of elements: 2)
EN	Execution condition	—	Bit	BOOL
ENO	Execution result	—	Bit	BOOL

*1 When specifying setting data by using a label, define an array to secure enough operation area and specify an element of the array label.

■Applicable devices

Operand	Bit		Word			Double word		Indirect specification	Constant			Others (U)
	X, Y, M, L, SM, F, B, SB, FX, FY	J□□	T, ST, C, D, W, SD, SW, FD, R, ZR, RD	U□\G□, J□□, U3E□(H)G□	Z	LT, LST, LC	LZ		K, H	E	\$	
(U)	GP.PFWRT	—	—	○	—	—	—	○	○	—	—	○
	ZP.PFWRT	—	—	○	—	—	—	○	—	—	○	○
(s)		—	—	○*3	—	—	—	○	—	—	—	—
(d)		○*1	—	○*2	—	—	—	—	—	—	—	—

- *1 FX and FY cannot be used.
- *2 T, ST, C, and FD cannot be used.
- *3 FD cannot be used.

■Control data

Operand: (s)					
Device	Item	Description	Setting range	Set by	
+0	System area	—	—	—	—
+1	Completion status	The instruction completion status is stored. • 0: Completed successfully • Other than 0: Completed with an error (error code)	—	System	

Processing details

- These instructions write the module extension parameters in the buffer memory to the module extension parameter file. For details, refer to the following.

📖 MELSEC iQ-R Positioning Module User's Manual (Application)

- The execution of the PFWRT instruction and whether it has been completed normally or with an error can be checked with the completion device (d) or completion status indication device (d)+1.

- Completion device (d)

This device turns on during the END processing of the scan where the PFWRT instruction completed, and turns off during the next END processing.

- Completion status indication device (d)+1

This device turns on or off depending on the completion status of the PFWRT instruction.

When completed normally: Unchanged from off.

When completed with an error: Turns on during the END processing of the scan where the PFWRT instruction completed, and turns off during the next END processing (the same on/off operation as the completion device is performed).

- The following figure shows the operation at completion of the PFWRT instruction.

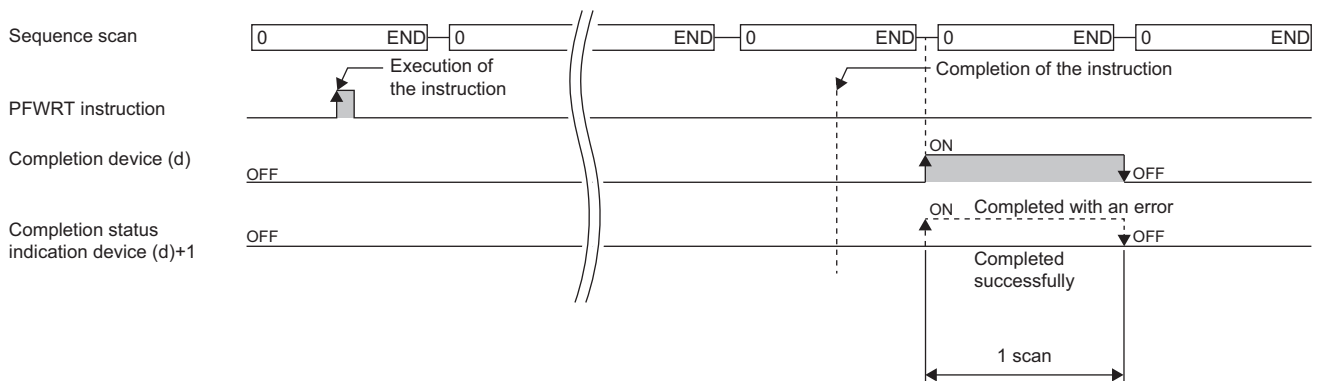

Precautions

- While the module extension parameters are being written by using the PFWRT instruction, do not power off the system or reset the CPU module. If the power is turned off or the CPU module is reset while the module extension parameters are being written, data is not normally written and normal positioning start is disabled. If normal positioning start is disabled, restart the system as follows.

Method	Description
Restart using the engineering tool	Write the positioning and block start data to the positioning module from the "Write to programmable controller" of the engineering tool.
Restart using the program	After initializing parameters by using the PINIT instruction, set the module extension parameters in the buffer memory of the positioning module. Thereafter, execute the PFWRT instruction.

- Data write to the flash ROM of the positioning module can repeat a maximum of one hundred thousand times. Any attempt to write data to the flash ROM beyond this count results in failure.
- After the power is turned on or the CPU module is reset once, data write can repeat a maximum of 25 times if the program is used. Any attempt to write data to the flash ROM memory beyond 25 times results in a flash ROM write count error at error code 1080H, resulting in failure in data write. If one try of write results in a flash ROM write count error, check and modify the write program. If a flash ROM write count error occurred, reset the error of the positioning module using "[Cd.5] Axis error reset," or turn on the power or reset the CPU module again.
- The PFWRT instruction is executed when the RD75 READY signal [X0] is off. While the RD75 READY signal [X0] is on, the instruction cannot be executed. Before executing the instruction, turn off both the PLC READY signal [Y0] and the RD75 READY signal [X0].

Operation error

Error code ((s)+1)	Description
1080H	Flash ROM write count error

11.5 Initializing the Module

GP.PINIT, ZP.PINIT



These instructions reset the module parameters and module extension parameters (positioning data and block start data) in the buffer memory, and the settings in the module extension parameter file to the factory default settings (initial values).

Ladder	ST
	<pre>ENO:=GP_PINIT(EN,U,s,d); ENO:=ZP_PINIT(EN,U,s,d);</pre>

FBD/LD

Execution condition

Instruction	Execution condition
GP.PINIT ZP.PINIT	

Setting data

Description, range, data type

Operand	Description	Range	Data type	Data type (label)
(U)	GP.PINIT Start I/O number (first three digits in four-digit hexadecimal representation) of a module	00H to FEH	16-bit unsigned binary	ANY16
	ZP.PINIT Start I/O number (first three digits in four-digit hexadecimal representation) of a module	00H to FEH	String	ANY16_OR_STRING_SINGLE
(s)	Start device where the control data is stored	Refer to the control data.	Device name	ANY16 ^{*1}
(d)	Device that turns on for one scan upon completion of the instruction If the instruction is completed with an error, (d)+1 is also turned on.	—	Bit	ANYBIT_ARRAY (Number of elements: 2)
EN	Execution condition	—	Bit	BOOL
ENO	Execution result	—	Bit	BOOL

*1 When specifying setting data by using a label, define an array to secure enough operation area and specify an element of the array label.

■Applicable devices

Operand	Bit		Word		Double word		Indirect specification	Constant			Others (U)	
	X, Y, M, L, SM, F, B, SB, FX, FY	J□□	T, ST, C, D, W, SD, SW, FD, R, ZR, RD	U□\G□, J□□, U3E□(H)G□	Z	LT, LST, LZ		LC	K, H	E		\$
(U)	GP.PINIT	—	—	○	—	—	—	○	○	—	—	○
	ZP.PINIT	—	—	○	—	—	—	○	—	—	○	○
(s)		—	—	○*3	—	—	—	○	—	—	—	—
(d)		○*1	—	○*2	—	—	—	—	—	—	—	—

*1 FX and FY cannot be used.

*2 T, ST, C, and FD cannot be used.

*3 FD cannot be used.

■Control data

Operand: (s)					
Device	Item	Description	Setting range	Set by	
+0	System area	—	—	—	—
+1	Completion status	The instruction completion status is stored. • 0: Completed successfully • Other than 0: Completed with an error (error code)	—	System	

Processing details

- These instructions reset the module parameters and module extension parameters in the buffer memory of the positioning module, and the settings in the module extension parameter file to the factory default settings (initial values). For details, refer to the following.

📖 MELSEC iQ-R Positioning Module User's Manual (Application)

- The setting data initialized include the parameters, positioning data (No.1 to 600), and block start data (No.7000 to 7004).
- The execution of the PINIT instruction and whether it has been completed normally or with an error can be checked with the completion device (d) or completion status indication device (d)+1.

- Completion device (d)

This device turns on during the END processing of the scan where the PINIT instruction completed, and turns off during the next END processing.

- Completion status indication device (d)+1

This device turns on or off depending on the completion status of the PINIT instruction.

When completed normally: Unchanged from off.

When completed with an error: Turns on during the END processing of the scan where the PINIT instruction completed, and turns off during the next END processing (the same on/off operation as the completion device is performed).

- The following figure shows the operation at completion of the PINIT instruction.

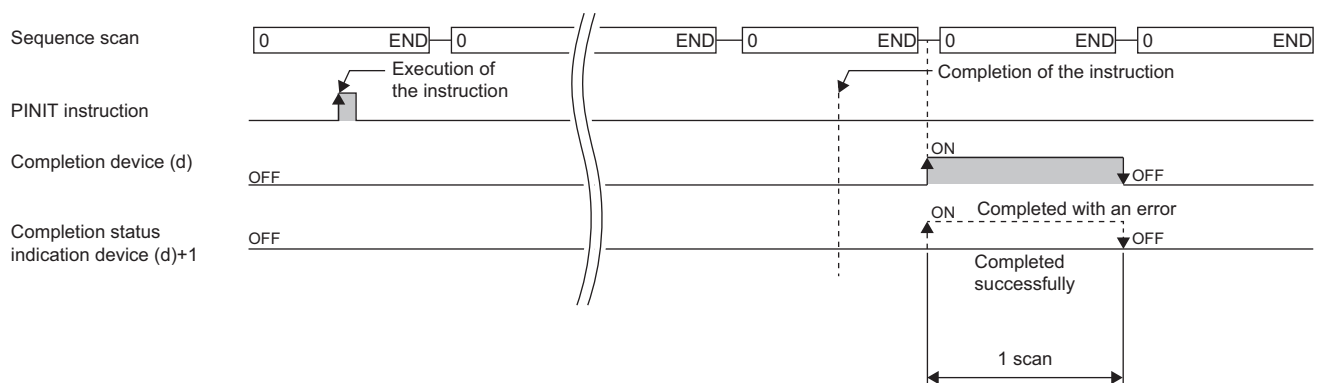

Precautions

- The PINIT instruction is executed when the RD75 READY signal [X0] is off. While the RD75 READY signal [X0] is on, the instruction cannot be executed. Before executing the instruction, turn off both the PLC READY signal [Y0] and the RD75 READY signal [X0].
- Data write to the flash ROM of the positioning module can repeat a maximum of one hundred thousand times. Any attempt to write data to the flash ROM beyond this count results in failure.
- After the power is turned on or the CPU module is reset once, initialization can repeat a maximum of 25 times if the program is used. Any attempt to write data to the flash ROM memory beyond 25 times results in a flash ROM write count error at error code 1080H, resulting in failure in data write. If one try of initialization results in a flash ROM write count error, check and modify the write program. If a flash ROM write count error occurred, reset the error of the positioning module using "[Cd.5] Axis error reset," or turn on the power or reset the CPU module again.

Operation error

Error code ((s)+1)	Description
1080H	Flash ROM write count error
1931H	Flash ROM write error

12 HIGH SPEED DATA LOGGER MODULE INSTRUCTIONS

Point

This chapter describes the instructions used commonly by MELSEC iQ-R series modules. When using MELSEC-Q series modules, refer to the manual for each module used and create programs.

For precautions when using modules, refer to the following.

 MELSEC iQ-R Module Configuration Manual

12.1 File Access Instructions

Recipe write

Z(P).RCPWRITE

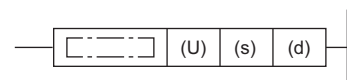

These instructions write the data in the CPU module to the specified recipe file in the SD memory card.

Ladder	ST
	<pre>ENO:=Z_RCPWRITE(EN,U,s,d); ENO:=ZP_RCPWRITE(EN,U,s,d);</pre>

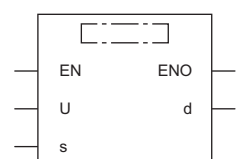
FBD/LD

Execution condition

Instruction	Execution condition
Z.RCPWRITE	
ZP.RCPWRITE	

Setting data

■Description, range, data type

Operand	Description	Range	Data type	Data type (label)
(U)	Start I/O number (first three digits in four-digit hexadecimal representation) of a module	00H to FEH	String	ANY16_OR_STRING_SINGLE
(s)	Start device where control data is stored	Page 481 Control data	Device name	ANY16 ^{*1}
(d)	Device that turns on for one scan upon completion of the instruction When the instruction completes with an error, (d)+1 also turns on.	—	Bit	ANYBIT_ARRAY (Number of elements: 2)
EN	Execution condition	—	Bit	BOOL
ENO	Execution result	—	Bit	BOOL

*1 When specifying setting data by using a label, define an array to secure enough operation area and specify an element of the array label.

The local device and the file register for each program are not available for setting data.

■Applicable devices

Operand	Bit		Word			Double word		Indirect specification	Constant			Others (U)
	X, Y, M, L, SM, F, B, SB, FX, FY	J□□	T, ST, C, D, W, SD, SW, FD, R, ZR, RD	U□□G□, J□□□, U3E□□(H)G□	Z	LT, LST, LC	LZ		K, H, E, \$			
(U)	—	—	○	—	—	—	○	—	—	○	○	
(s)	—	—	○ ^{*2}	—	—	—	○	—	—	—	—	
(d)	○ ^{*1}	—	○ ^{*3}	—	—	—	—	—	—	—	—	

*1 FX and FY cannot be used.

*2 FD cannot be used.

*3 T, ST, C, and FD cannot be used.

■Control data

Operand: (s)				
Device	Item	Description	Setting range	Set by
+0	System area	—	—	—
+1	Completion status	The completion status is stored upon completion of the instruction. • 0: Completed successfully • Other than 0: Completed with an error (error code)	—	System
+2	Record number	Record number of data to be written ^{*1}	1 to 256	User
+3 to +7	System area	—	—	—
+8 to +23	File name	Specifies the recipe name in which the data of the CPU module is written. ^{*2} (Up to 32 characters)	String	User
+24 to +31	System area	—	—	—

*1 Refer to the recipe file format. (MELSEC iQ-R High Speed Data Logger Module User's Manual(Application))

*2 Specify the recipe file name in ASCII code.

Processing details

- Specify the recipe file of the SD memory card and then write the data of the CPU module to the recipe file.
- A file from the RECIPE folder of the SD memory card can be specified as the recipe file.
- Normal/error completion of the Z(P).RCPWRITE instruction can be checked with the completion device (d) and the completion status indication device (d)+1.

- Completion device (d)

This device turns on during END processing of the scan where the Z(P).RCPWRITE instruction completes, and turns off during the next END processing.

- Completion status indication device (d)+1

The completion device turns on or off depending on the completion status of the Z(P).RCPWRITE instruction.

When completed successfully: The device remains off.

When completed with an error: The device turns on during END processing of the scan where the Z(P).RCPWRITE instruction completes, and turns off during the next END processing.

- The following figure shows the operation at the completion of the Z(P).RCPWRITE instruction.

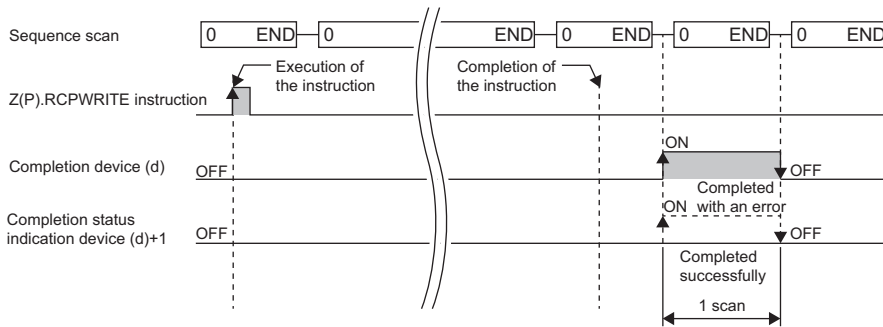

Program example

The following shows an example of a program in which the high speed data logger module mounted in the position of the I/O number X00 to X1F/Y00 to Y1F writes the data of the CPU module in the device value of record 4 of the file (recipe01.CSV) in the RECIPE folder, if M28 is turned ON.

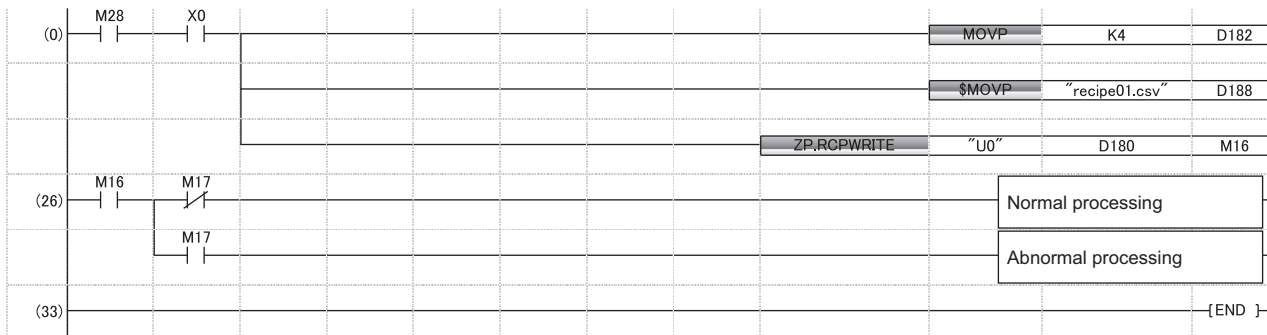

Precautions

- The Z(P).RCPWRITE instruction cannot be executed additionally while another Z(P).RCPWRITE instruction is being executed. (If executed, no processing is performed.) For errors detected at the instruction execution, the completion device (d) and completion status indication device (d)+1 are not turned ON.
- The Z(P).RCPWRITE instruction cannot be executed when the module stop error is being occurred, or the data logging function cannot be performed (X5: OFF). (If attempted, an error occurs at the instruction completion.)
- An error may occur when the instruction (Z(P).RCPREAD) other than the Z(P).RCPWRITE instruction is accessing the same file. When accessing the same file, apply an interlock between the dedicated instructions.
- The Z(P).RCPWRITE instruction cannot be used in the interrupt program.

Operation error

Error code ((s)+1)	Description
1000H to 3FFFH	MELSEC iQ-R High Speed Data Logger Module User's Manual(Application)

When the instruction completes with an error, the completion status indication device (d)+1 turns on and an error code is stored in the completion status (s)+1.

Recipe read

Z(P).RCPREAD



These instructions reads device values of the specified recipe file in the SD memory card to the CPU module.

Ladder	ST
	<pre>ENO:=Z_RCPREAD(EN,U,s,d); ENO:=ZP_RCPREAD(EN,U,s,d);</pre>

FBD/LD

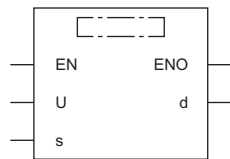

Execution condition

Instruction	Execution condition
Z.RCPREAD	
ZP.RCPREAD	

Setting data

Description, range, data type

Operand	Description	Range	Data type	Data type (label)
(U)	Start I/O number (first three digits in four-digit hexadecimal representation) of a module	00H to FEH	String	ANY16_OR_STRING_SINGLE
(s)	Start device where control data is stored	Page 485 Control data	Device name	ANY16 ^{*1}
(d)	Device that turns on for one scan upon completion of the instruction When the instruction completes with an error, (d)+1 also turns on.	—	Bit	ANYBIT_ARRAY (Number of elements: 2)
EN	Execution condition	—	Bit	BOOL
ENO	Execution result	—	Bit	BOOL

*1 When specifying setting data by using a label, define an array to secure enough operation area and specify an element of the array label.

The local device and the file register for each program are not available for setting data.

Applicable devices

Operand	Bit		Word			Double word		Indirect specification	Constant			Others (U)
	X, Y, M, L, SM, F, B, SB, FX, FY	J□□	T, ST, C, D, W, SD, SW, FD, R, ZR, RD	U□\G□, J□□, U3E□\(\H)G□	Z	LT, LST, LC	LZ		K	H	E	
(U)	—	—	○	—	—	—	○	—	—	○	○	○
(s)	—	—	○ ^{*2}	—	—	—	○	—	—	—	—	—
(d)	○ ^{*1}	—	○ ^{*3}	—	—	—	—	—	—	—	—	—

*1 FX and FY cannot be used.

*2 FD cannot be used.

*3 T, ST, C, and FD cannot be used.

Control data

Operand: (s)				
Device	Item	Description	Setting range	Set by
+0	System area	—	—	—
+1	Completion status	The completion status is stored upon completion of the instruction. • 0: Completed successfully • Other than 0: Completed with an error (error code)	—	System
+2	Record number	Record number of data to be read ^{*1}	1 to 256	User
+3 to +7	System area	—	—	—
+8 to +23	File name	Specifies the recipe name in which the data of the CPU module is read. ^{*2} (Up to 32 characters)	String	User
+24 to +31	System area	—	—	—

*1 Refer to the recipe file format. (MELSEC iQ-R High Speed Data Logger Module User's Manual(Application))

*2 Specify the recipe file name in ASCII code.

Processing details

- Specify the recipe file of the SD memory card and then read the device value on the recipe file to the CPU module.
- A file from the RECIPE folder of the SD memory card can be specified as the recipe file.
- Normal/error completion of the Z(P).RCPREAD instruction can be checked with the completion device (d) and the completion status indication device (d)+1.
 - Completion device (d)
 - This device turns on during END processing of the scan where the Z(P).RCPREAD instruction completes, and turns off during the next END processing.
 - Completion status indication device (d)+1

The completion device turns on or off depending on the completion status of the Z(P).RCPREAD instruction.

When completed successfully: The device remains off.

When completed with an error: The device turns on during END processing of the scan where the Z(P).RCPREAD instruction completes, and turns off during the next END processing.

- The following figure shows how the Z(P).RCPREAD instruction operates during execution.

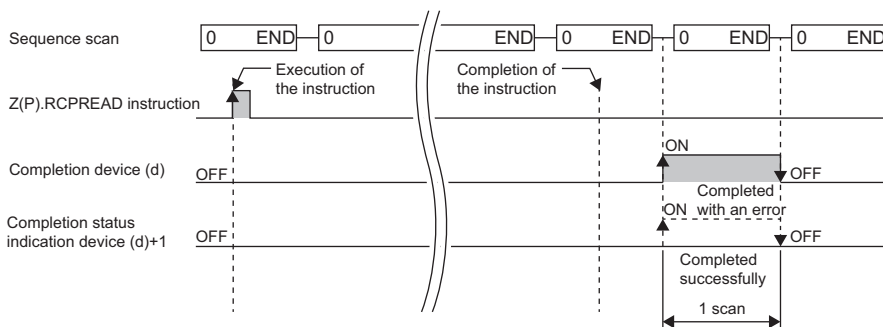

■ Program example

The following shows an example of a program in which the high speed data logger module mounted in the position of the I/O number X00 to X1F/Y00 to Y1F, reads the data of the device value of record 1 of the file (recipe01.CSV) in the RECIPE folder to the CPU module, if M28 is turned ON.

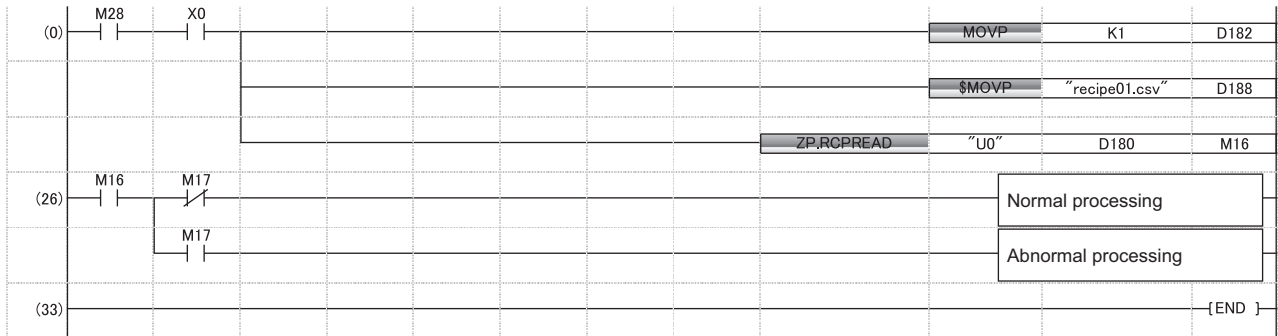

Precautions

- The Z(P).RCPREAD instruction cannot be executed additionally while another Z(P).RCPREAD instruction is being executed. (If executed, no processing is performed.) For errors detected at the instruction execution, the completion device (d) and completion status indication device (d)+1 are not turned ON.
- The Z(P).RCPREAD instruction cannot be executed when the module stop error is being occurred, or the data logging function cannot be performed (X5: OFF). (If attempted, an error occurs at the instruction completion.)
- An error may occur when the instruction (Z(P).RCPWRITE) other than the Z(P).RCPREAD instruction is accessing the same file. When accessing the same file, apply an interlock between the dedicated instructions.
- The Z(P).RCPREAD instruction cannot be used in the interrupt program.

Operation error

Error code ((s)+1)	Description
1000H to 3FFFH	MELSEC iQ-R High Speed Data Logger Module User's Manual(Application)

When the instruction completes with an error, the completion status indication device (d)+1 turns on and an error code is stored in the completion status (s)+1.

13 C INTELLIGENT FUNCTION MODULE INSTRUCTIONS

Point 

For precautions when using modules, refer to the following.
 MELSEC iQ-R Module Configuration Manual

13.1 User Function Execution Instruction

User function execution

G(P).CEXECUTE

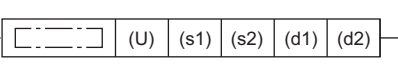

These instructions instruct to execute a function for the pre-registered function.

Ladder	ST
	<pre>ENO:=G_CEXECUTE(EN,U,s1,s2,d1,d2); ENO:=GP_CEXECUTE(EN,U,s1,s2,d1,d2);</pre>

FBD/LD

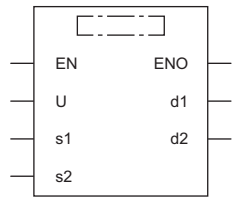

Execution condition

Instruction	Execution condition
G.CEXECUTE	
GP.CEXECUTE	

Setting data

■Description, range, data type

Operand	Description	Range	Data type	Data type (label)
(U)	Start I/O number (first three digits in four-digit hexadecimal representation) of a module	00H to FEH	16-bit unsigned binary	ANY16
(s1)	Start device where control data is stored	Page 488 Control data	Device name	ANY16
(s2)	Start device where request data is stored	—*1	Device name	ANY16
(d1)	Start device for storing response data	—*1	Device name	ANY16
(d2)	Device that turns on for one scan upon completion of the instruction When the instruction completes with an error, (d2)+1 also turns on.	—	Bit	ANYBIT_ARRAY (Number of elements: 2)
EN	Execution condition	—	Bit	BOOL
ENO	Execution result	—	Bit	BOOL

*1 The maximum size of response data and request data will be 8K words.

■Applicable devices

Operand	Bit		Word			Double word		Indirect specification	Constant			Others (U)
	X, Y, M, L, SM, F, B, SB, FX, FY	J□\□	T, ST, C, D, W, SD, SW, FD, R, ZR, RD	U□\G□, J□\□, U3E□\□(H)G□	Z	LT, LST, LC	LZ		K, H	E	\$	
(U)	—	—	○	—	—	—	○	○	—	—	○	
(s1)	—	—	○*2	—	—	—	○	—	—	—	—	
(s2)	—	—	○*2	—	—	—	○	—	—	—	—	
(d1)	—	—	○*2	—	—	—	○	—	—	—	—	
(d2)	○*1	—	○*3	—	—	—	—	—	—	—	—	

*1 FX and FY cannot be used.

*2 FD cannot be used.

*3 T, ST, C, and FD cannot be used.

■Control data

Operand: (s1)				
Device	Item	Description	Setting range	Set by
+0	Allowable amount of response data	Sets the allowable number of words of response data that can be stored in (d1).	1 to 8192	User
+1	Completion status	The completion status is stored upon completion of the instruction. • 0: Completed successfully • Other than 0: Completed with an error (error code)	—	System

■Request data

Operand: (s2)				
Device	Item	Description	Setting range	Set by
+0	Request data length	Specify the request data length. (Number of words)	1 to 8192	User
+1 to +□	Request data	Specify the request data.	—	User

■Response data

Operand: (d1)				
Device	Item	Description	Setting range	Set by
+0	Response data length	Response data length is stored. (Number of words)	0 to 8192	System
+1 to +□	Response data	Response data is stored.	—	System

Processing details

- The request data stored in the device specified by (s2) and later is handed over to the C intelligent function module specified by (U), and the response data is stored in the device specified by (d1) and later. However, if the received response data is larger than the allowed number of response data specified in (s1), only the allowed number of response data will be stored and the remaining will be discarded. However, if the received response data is larger than the allowed number of response data specified in (s1), only the allowed number of response data will be stored and the remaining will be discarded. (Dedicated instruction will be completed successfully.) In this case, the response data length (d1) will be the number of data actually stored.

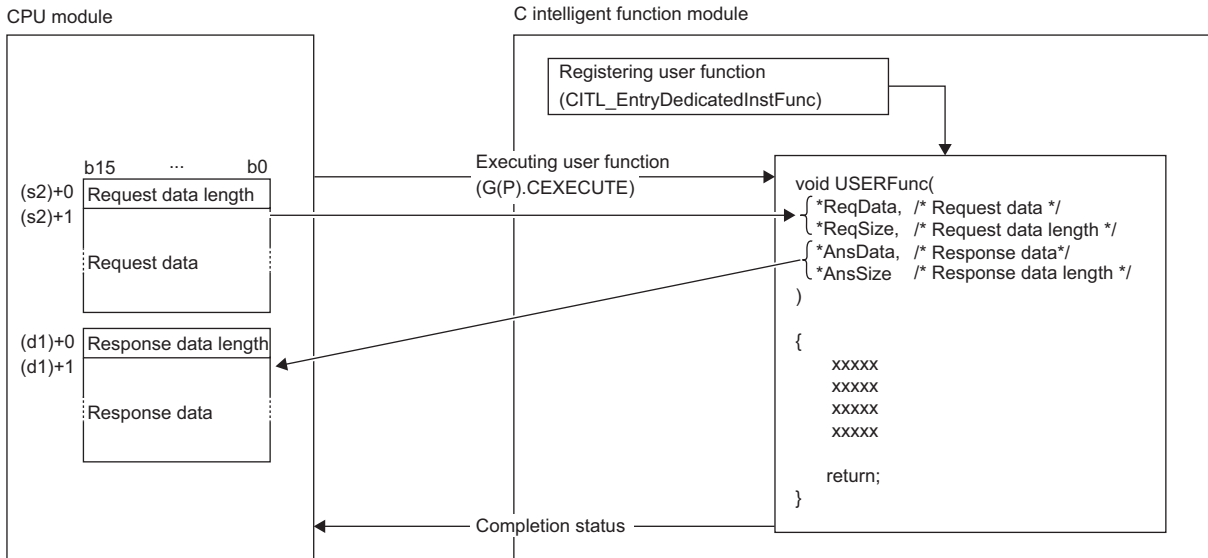

The user program runs in the following tasks settings.

- Task priority: 100
- Stack size: 40000 bytes
- Task option: VX_FP_TASK

- The completion status of the G(P).CEXECUTE instruction can be checked with the completion device (d2) and the completion status indication device (d2)+1.

- Completion device (d2)

This device turns on during END processing of the scan where the G(P).CEXECUTE instruction completes, and turns off during the next END processing.

- Completion status indication device (d2)+1

When completed successfully: The device remains off.

When completed with an error: The device turns on during END processing of the scan where the G(P).CEXECUTE instruction completes, and turns off during the next END processing.

- The following figure shows how the G(P).CEXECUTE instruction operates during execution.

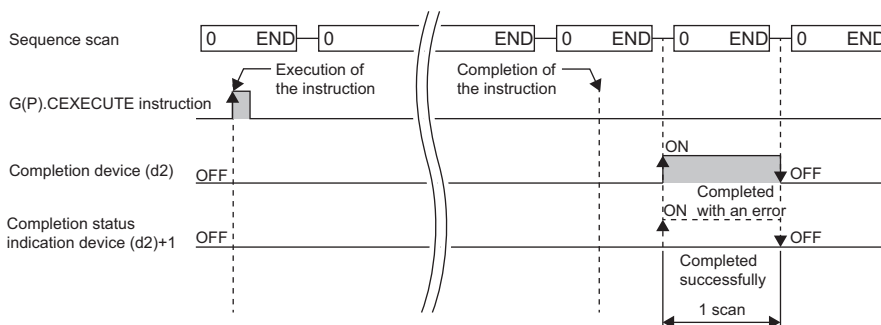

Program example

The following shows an example of a program that receives response data from D20 after the request data is set from D10 to D12.

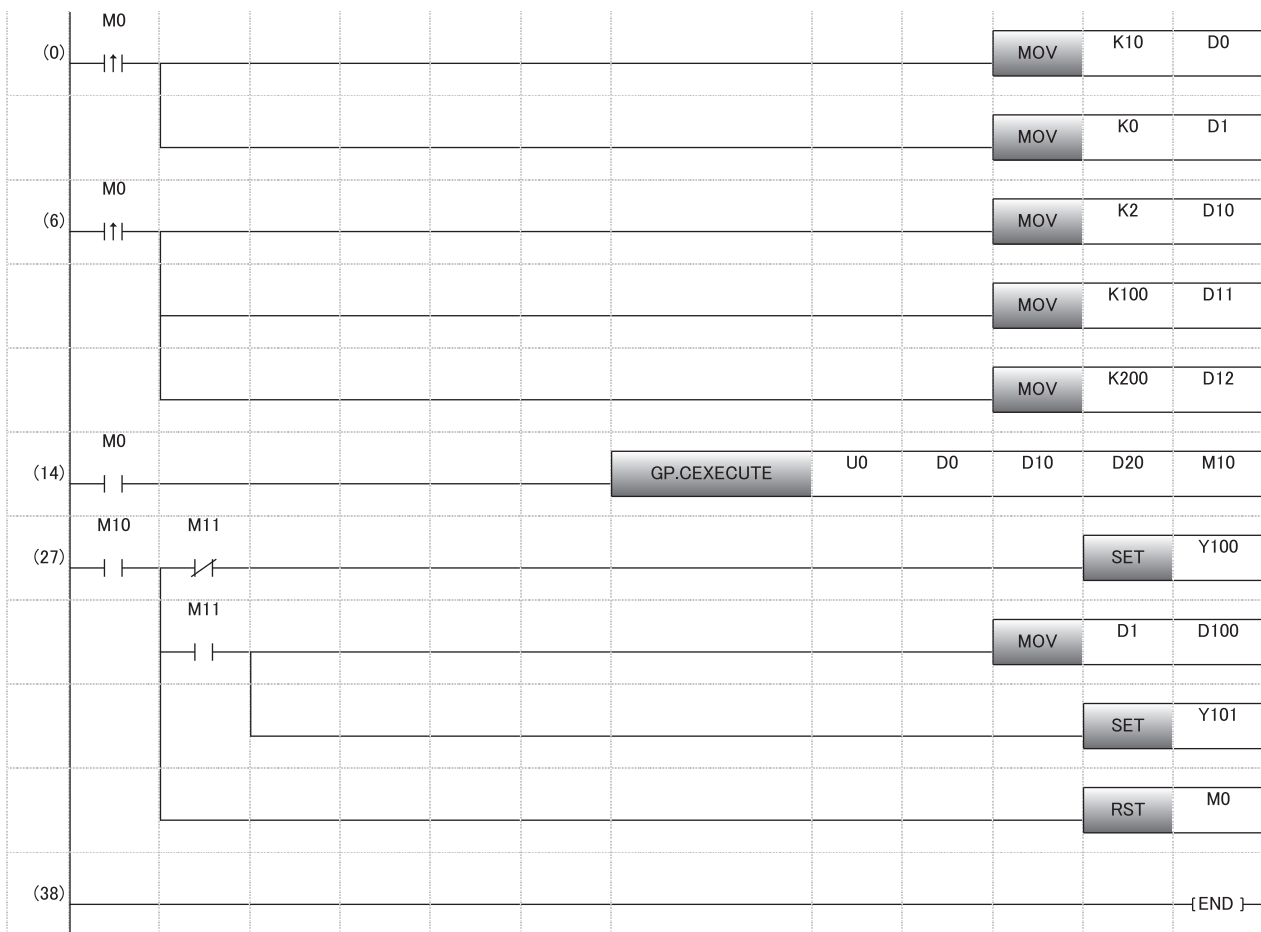

Precautions

- Before executing the G(P).CEEXECUTE instruction, the user function must be registered using the C intelligent function module dedicated function (CITL_EntryDedicatedInstFunc). If the user function is unregistered, a 'user function unregistered error' (1800H) will be returned. In addition, 1 user function can be executed by the G(P).CEEXECUTE instruction. If you want to run multiple functions, prepare the data for identifying functions in request data, then call the functions distinctly using the conditional branches in user function.
- During the execution of the G(P).CEEXECUTE instruction, neither a dedicated instruction nor an FB can be executed for the same C intelligent function module. The operation under the situation as previously noted is not guaranteed; therefore, arrange a program that executes a dedicated instruction or an FB after the completion device (d2) turns on.
- The local device and the file register for each program are not available for setting data.
- Operand must be specified even when request data and response data are not required.

Operation error

Error code ((s1)+1)	Description
1000H to 3FFFH	MELSEC iQ-R C Intelligent Function Module User's Manual (Application)

When the instruction completes with an error, the completion status indication device (d2)+1 turns on and an error code is stored in the completion status (s1)+1.

13.2 Data Analysis Function Execution Instruction

Digital filter operation

G(P).DIGIFLTR

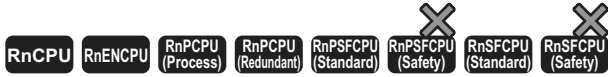

• RD55UP06-V with the firmware version "07" or later is available. For an engineering tool, version "1.050C" or later is available.

This instruction performs digital filter operation for the specified wave.

Ladder	ST
	<pre>ENO:=G_DIGIFLTR(EN,U,s,d); ENO:=GP_DIGIFLTR(EN,U,s,d);</pre>

FBD/LD

Execution condition

Instruction	Execution condition
G.DIGIFLTR	
GP.DIGIFLTR	

13

Setting data

Description, range, data type

Operand	Description	Range	Data type	Data type (label)
(U)	Start I/O number (first three digits in four-digit hexadecimal representation) of a module	00H to FEH	16-bit unsigned binary	ANY16
(s)	Start device where control data is stored	Page 492 Control data	Device name	ANY16 ^{*1}
(d)	Device that turns on for one scan upon completion of the instruction When the instruction completes with an error, (d)+1 also turns on.	—	Bit	ANYBIT_ARRAY (Number of elements: 2)
EN	Execution condition	—	Bit	BOOL
ENO	Execution result	—	Bit	BOOL

*1 To set a data type using a label, define an array for allocating an area required for the operation first, then specify an element of the array type label.

■Applicable devices

Operand	Bit		Word				Double word		Indirect specification	Constant			Others (U)
	X, Y, M, L, SM, F, B, SB, FX, FY	J□□	T, ST, C, D, W, SD, SW, FD, R, ZR, RD	U□V□, J□□, U3E□(H)G□	Z	LT, LST, LC	LZ	K, H, E, \$					
(U)	—	—	○*1	—	—	—	—	○	○	—	—	○	
(s)	—	—	○*1	—	—	—	—	○	—	—	—	—	
(d)	○*2	—	○*3	—	—	—	—	—	—	—	—	—	

*1 FD cannot be used.

*2 FX and FY cannot be used.

*3 T, ST, C, and FD cannot be used.

■Control data

Operand: (s)				
Device	Item	Description	Setting range	Set by
+0	System area	—	—	—
+1	Completion status	The completion status is stored upon completion of the instruction. • 0: Completed successfully • Other than 0: Completed with an error (error code)	—	System
+2 +3	Start address of input data storage destination	Specify a start address of the buffer memory of a C intelligent function module where wave data to be calculated is stored. • Data for the specified number of data points is read from the specified start address and its consecutive address in the buffer memory, and is used for operation. • Before executing this dedicated instruction, store the wave data to be calculated in the buffer memory.	16384 to 2097151	User
+4 +5	Number of data points	Specify the number of array elements of wave data to be operated.	16 to 1000000	User
+6 +7	Sampling cycle	Specify the sampling cycle of the wave data to be operated.	1 to 1000000 (us)	User
+8 +9	Frequency response filter type	Specify a filter type. • 0: Low-pass filter (LPF) • 1: High-pass filter (HPF) • 2: Band-pass filter (BPF) • 3: Band elimination filter (BEF)	0 to 3	User
+10 +11	Cutoff frequency 1	Specify a cutoff frequency 1 [Hz]. • Specify a value less than the one obtained by dividing the sampling frequency by 2. • Store a value in single-precision real number format.	A value greater than '0'	User
+12 +13	Cutoff frequency 2	Specify a cutoff frequency 2 [Hz]. It is used only when band-pass filter (BPF) or band elimination filter (BEF) is specified. When low-pass filter (LPF) or high-pass filter (HPF) is specified, it is ignored. • Specify a value greater than or equal to the one set for the cutoff frequency 1. • Specify a value less than the one obtained by dividing the sampling frequency by 2. • Store a value in single-precision real number format.	A value greater than '0'	User
+14 +15	Digital filter type	Specify a filter type. • 0: FIR filter • 1: IIR filter (Butterworth) • 2: IIR filter (Chebyshev) IIR filter can be used only when either low-pass filter (LPF) or high-pass filter (HPF) is specified. If band-pass filter (BPF) or band elimination filter (BEF) is specified, it will be fixed as FIR filter.	0 to 2	User
+16 +17	Degree	Specify a degree. • Depending on the specified digital filter type, the available range of values differs. For FIR filter: 2 to 200 (even number only) For IIR filter: 2 to 40 • Specify a value less than or equal to the one set to the number of data points.	2 to 200	User
+18 +19	Ripple	Specify a ripple [dB]. It is used only when IIR filter (Chebyshev) is specified for the digital filter type. When FIR filter or IIR filter (Butterworth) is specified, it is ignored. • Store a value in single-precision real number format.	0.015625 to 1.0	User

Operand: (s)				
Device	Item	Description	Setting range	Set by
+20 +21	Start address of output data	Specify a start address of the buffer memory of a C intelligent function module to store an operation result. <ul style="list-style-type: none"> • Data for the specified the number of data points is stored to the specified start address and its consecutive address in the buffer memory as an operation result. • An operation result is stored as a single-precision real number. 	16384 to 2097150	User
+22 +23	Wave data type selection	Specify a data type of the wave to be analyzed. <ul style="list-style-type: none"> • 0: Word [signed] • 1: Double word [signed] • 2: Single-precision real number 	0 to 2	User

Processing details

- For the C intelligent function module specified to (U), the data analysis function (DANL_DigitalFilter) for C intelligent function modules is called using a value specified to (s). The result is stored to the buffer memory address specified to (s)+20 and (s)+21 and its consecutive address.
- Digital filter operation is performed for the wave data specified to the start address of input data storage destination.
- Wave data for performing digital filter operation is read from the buffer memory address specified for the start address of input data storage destination for the specified number of data points. For the buffer memory address specified for the start address of input data storage destination and its consecutive address, data for the specified number of data point should be stored in advance.
- Data for the specified number of data points is stored to the buffer memory address specified for the start address of output data and its consecutive address as an operation result. For the buffer memory address specified for the start address of output data and its consecutive address, reserve an area larger than or equal to the specified number of data points.
- This dedicated instruction supports the frequency response filter types, such as low-pass filter, high-pass filter, band-pass filter, and band elimination filter.
- This dedicated instruction supports digital filters, such as FIR filter, IIR filter (Butterworth), and IIR filter (Chebyshev).
- This instruction uses buffer memory for input data and an operation result.

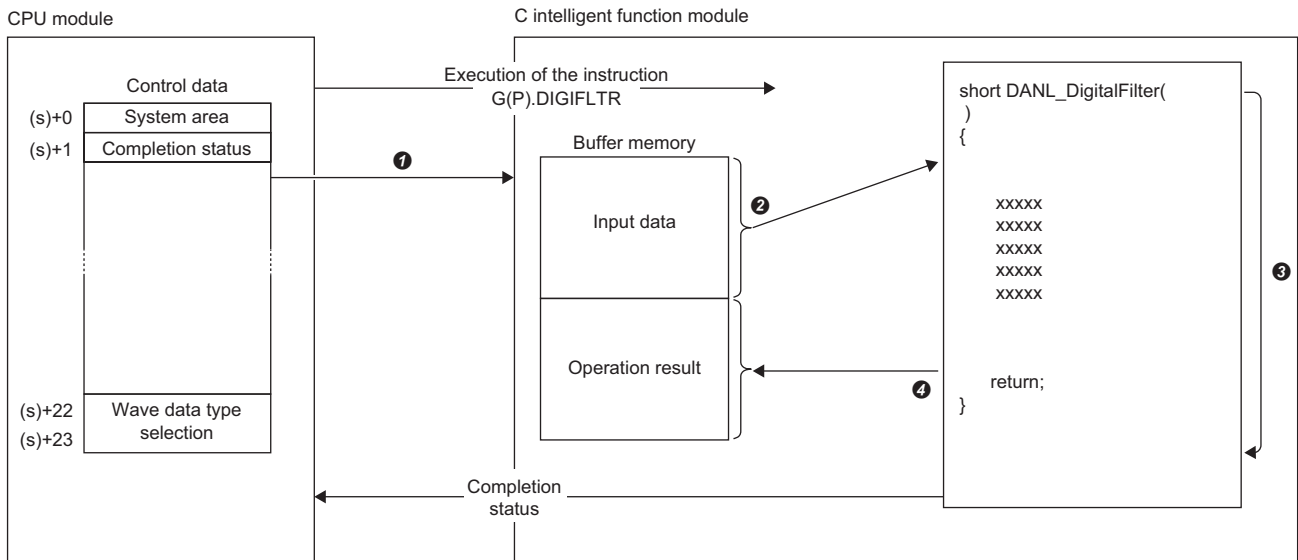

- ➊ A value specified in the control data is passed to a C intelligent function module.
- ➋ Data for the same number of points specified for the number of data points is read from the buffer memory.
- ➌ The data analysis function (DANL_DigitalFilter) is executed.
- ➍ Data for the same number of points specified for the number of data points is written to the buffer memory.

Item	Description
Input data	From the buffer memory address specified to (s)+2 and (s)+3, data for the same size specified to (s)+4 and (s)+5 is calculated. Before executing this dedicated instruction, store the wave data to be calculated in the buffer memory.
Operation result	From the buffer memory address specified to (s)+20 and (s)+21, data for the same size specified to (s)+4 and (s)+5 is stored as an operation result.

- The completion status of the G(P).DIGIFLTR instruction can be checked with the completion device (d) and the completion status indication device (d)+1.
 - Completion device (d)
This device turns on during END processing of the scan where the G(P).DIGIFLTR instruction completes, and turns off during the next END processing.
 - Completion status indication device (d)+1
When completed successfully: The device remains off.
When completed with an error: This device turns on during END processing of the scan where the G(P).DIGIFLTR instruction completes, and turns off during the next END processing.
- The following figure shows how the G(P).DIGIFLTR instruction operates during execution.

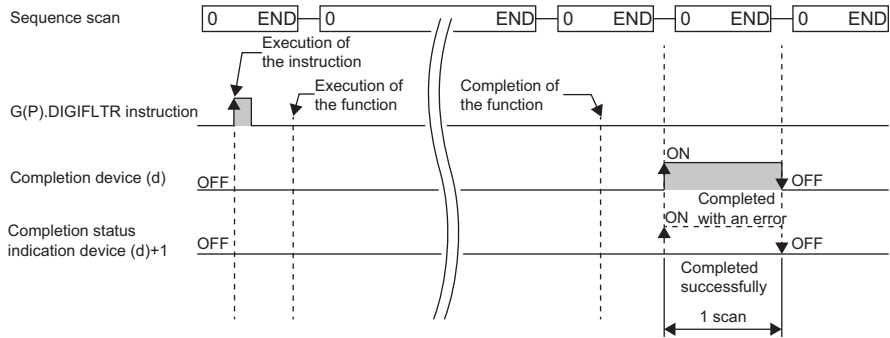

■ Operation example of the frequency response filter

The following shows an example when each filter is applied to the synthetic wave (2) which consists of three waves shown in the composed wave (1).

In the following figure, the horizontal axis indicates time and the vertical axis indicates amplitude.*1

*1 The following is an example of an operation. The actual results may vary.

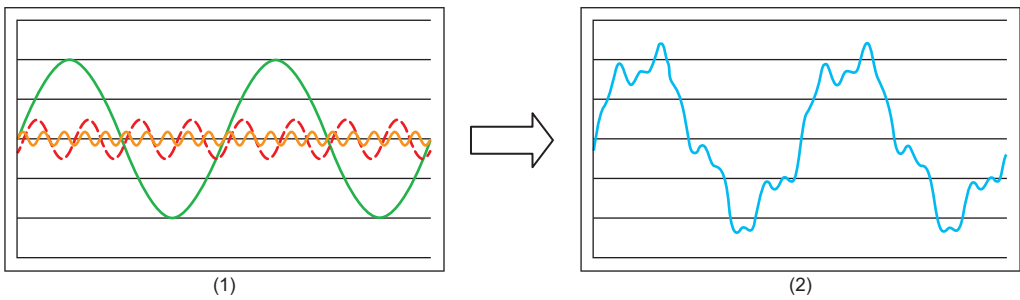

Filter type	Feature
Low-pass filter	Attenuates and terminates signals with frequencies higher than the specified frequency to pass only low frequency signals.
High-pass filter	Attenuates and terminates signals with frequencies lower than the specified frequency to pass only high frequency signals.
Band-pass filter	Passes only signals with frequencies within the specified range.
Band elimination filter	Eliminates frequency signals within the specified range.

● Low-pass filter

A low-pass filter attenuates and terminates signals with a frequency higher than the one specified to the cutoff frequency 1 to pass only low frequency signals.

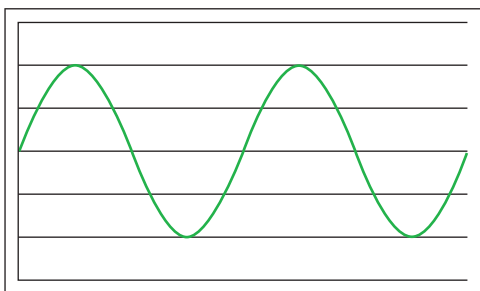

● High-pass filter

A high-pass filter reduces and terminates signals with frequencies lower than the frequency specified to the cutoff frequency 1 to pass only high frequency signals.

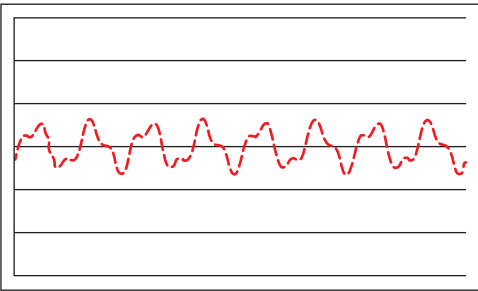

● Band-pass filter

A band-pass filter passes signals with a frequency higher than the one specified to the cutoff frequency 1 and lower than the one specified to the cutoff frequency 2.

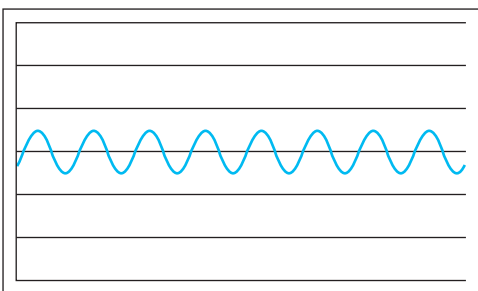

● Band elimination filter

A band elimination filter eliminates signals with a frequency higher than the one specified to the cutoff frequency 1 and lower than the one specified to the cutoff frequency 2.

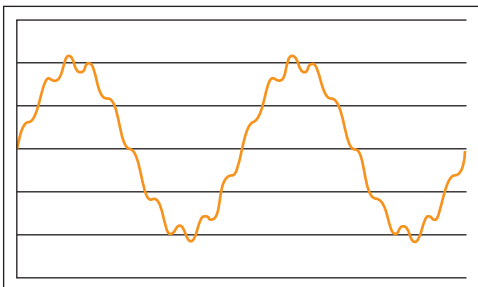

Precautions

- The input and output data type of a data analysis library that is executed by this dedicated instruction is single-precision real number; therefore, specifying double-word type for (s)+22 and (s)+23 may lead to a loss of trailing digits.
- During the execution of this dedicated instruction, neither a dedicated instruction nor an FB can be executed for the same C intelligent function module. The operation under the situation as previously noted is not guaranteed; therefore, arrange a program that executes a dedicated instruction or an FB after the completion device (d) turns on.
- When specifying control data using an array label, for the item that stores single-precision real number, the value of a single-precision real number should be temporarily stored to a word device, such as a data register, using the EMOV instruction. After that, store the value to a desired array label using the DMOV instruction. Additionally, when storing control data to an array label, the data type of the array label will be word type since the data type of an array label is 'ANY16'; however, values should be stored to (s)+10, (s)+11, (s)+12, (s)+13, (s)+18, and (s)+19 in a single-precision real number, and therefore the values cannot be stored directly.

Operation error

Error code ((s)+1)	Description
0000H to 3FFFH	 MELSEC iQ-R C Intelligent Function Module User's Manual (Application)

When the instruction completes with an error, the completion status indication device (d)+1 turns on and an error code is stored to the completion status (s)+1.

Envelope calculation

G(P).ENVCALC



• RD55UP06-V with the firmware version "07" or later is available. For an engineering tool, version "1.050C" or later is available.

This instruction calculates the envelope of the specified wave.

Ladder	ST
	<pre>ENO:=G_ENVCALC(EN,U,s,d); ENO:=GP_ENVCALC(EN,U,s,d);</pre>

FBD/LD

Execution condition

Instruction	Execution condition
G.ENVCALC	
GP.ENVCALC	

Setting data

Description, range, data type

Operand	Description	Range	Data type	Data type (label)
(U)	Start I/O number (first three digits in four-digit hexadecimal representation) of a module	00H to FEH	16-bit unsigned binary	ANY16
(s)	Start device where control data is stored	Page 499 Control data	Device name	ANY16 ^{*1}
(d)	Device that turns on for one scan upon completion of the instruction When the instruction completes with an error, (d)+1 also turns on.	—	Bit	ANYBIT_ARRAY (Number of elements: 2)
EN	Execution condition	—	Bit	BOOL
ENO	Execution result	—	Bit	BOOL

*1 To set a data type using a label, define an array for allocating an area required for the operation first, then specify an element of the array type label.

Applicable devices

Operand	Bit	Word			Double word		Indirect specification	Constant			Others (U)
	X, Y, M, L, SM, F, B, SB, FX, FY	J□□□	T, ST, C, D, W, SD, SW, FD, R, ZR, RD	U□□□□, J□□□□, U3E□□(H)G□	Z	LT, LST, LC		LZ	K, H	E	
(U)	—	—	○ ^{*1}	—	—	—	○	○	—	—	○
(s)	—	—	○ ^{*1}	—	—	—	○	—	—	—	—
(d)	○ ^{*2}	—	○ ^{*3}	—	—	—	—	—	—	—	—

*1 FD cannot be used.

*2 FX and FY cannot be used.

*3 T, ST, C, and FD cannot be used.

Control data

Operand: (s)				
Device	Item	Description	Setting range	Set by
+0	System area	—	—	—
+1	Completion status	The completion status is stored upon completion of the instruction. • 0: Completed successfully • Other than 0: Completed with an error (error code)	—	System
+2 +3	Start address of input data storage destination	Specify a start address of the buffer memory of a C intelligent function module where wave data to be calculated is stored. • Data for the specified number of sampling points is read from the specified start address and its consecutive address in the buffer memory, and is used for operation. • Before executing this dedicated instruction, store the wave data to be calculated in the buffer memory.	16384 to 2097151	User
+4 +5	Number of sampling points	Specify the number of array elements of wave data to be operated.	64, 128, 256, 512, 1024, 2048, 4096, 8192, 16384, 32768	User
+6 +7	Start address of output data	Specify a start address of the buffer memory of a C intelligent function module to store an operation result. • Data for the specified the number of sampling points is stored to the specified start address and its consecutive address in the buffer memory as an operation result. • An operation result is stored as a single-precision real number.	16384 to 2097150	User
+8 +9	Wave data type selection	Specify a data type of the wave to be analyzed. • 0: Word [signed] • 1: Double word [signed] • 2: Single-precision real number	0 to 2	User

Processing details

- For the C intelligent function module specified to (U), the data analysis function (DANL_EnvelopeCalculation) for C intelligent function modules is called using a value specified to (s). The result is stored to the buffer memory specified to (s)+6 and (s)+7 and its consecutive address.
- An envelope of the wave data specified to the start address of input data storage destination can be calculated.

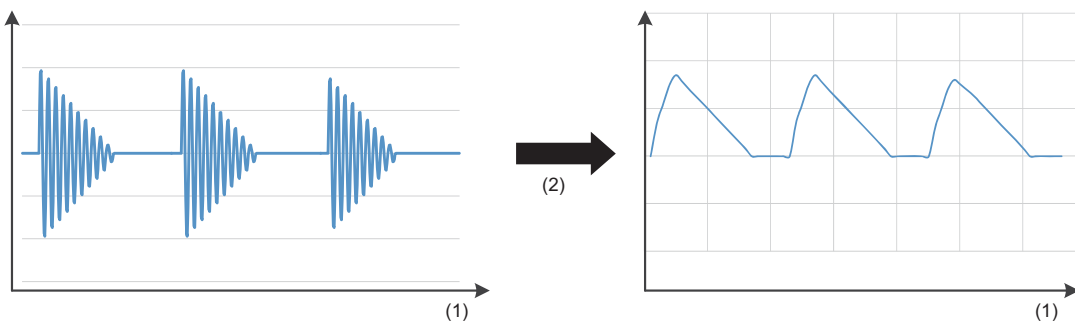

(1) Time
(2) Envelope calculation

- Wave data for calculating an envelope is read from the buffer memory address specified to the start address of input data storage destination for the size specified to the number of sampling points. For the buffer memory address specified to the start address of input data storage destination and its consecutive address, data for the specified number of sampling points should be stored in advance.
- Data for the specified number of sampling points is stored to the buffer memory address specified for the start address of output data and its consecutive address as an operation result. For the buffer memory address specified for the start address of output data and its consecutive address, reserve an area larger than or equal to the specified number of sampling points.
- If an overflow occurs during operation, review the input data. A value stored at the occurrence of an overflow varies depending on each engineering tool. Check the specification of the engineering tool used.

- This instruction uses buffer memory for input data and an operation result.

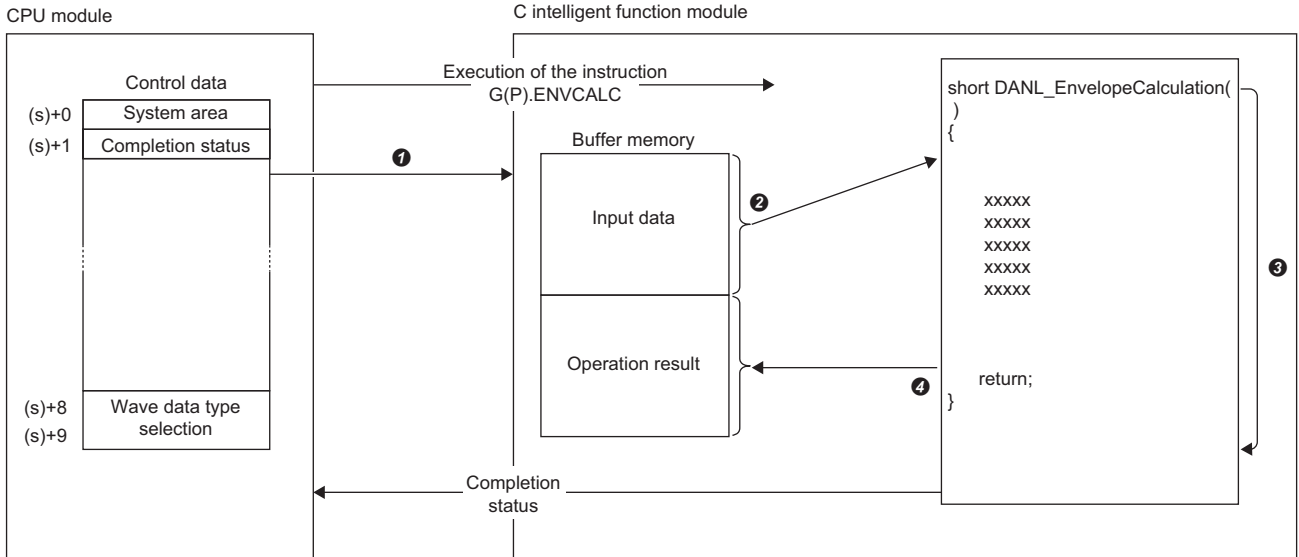

- ➊ A value specified in the control data is passed to a C intelligent function module.
- ➋ Data for the same number of points specified for the number of sampling points is read from the buffer memory.
- ➌ The data analysis function (DANL_EnvelopeCalculation) is executed.
- ➍ Data for the same number of points specified for the number of sampling points is written to the buffer memory.

Item	Description
Input data	From the buffer memory address specified to (s)+2 and (s)+3, data for the same size specified to (s)+4 and (s)+5 is calculated. Before executing this dedicated instruction, store the wave data to be calculated in the buffer memory.
Operation result	From the buffer memory address specified to (s)+6 and (s)+7, data for the same size specified to (s)+4 and (s)+5 is stored as an operation result.

- The completion status of the G(P).ENVCALC instruction can be checked with the completion device (d) and the completion status indication device (d)+1.

- Completion device (d)

This device turns on during END processing of the scan where the G(P).ENVCALC instruction completes, and turns off during the next END processing.

- Completion status indication device (d)+1

When completed successfully: The device remains off.

When completed with an error: This device turns on during END processing of the scan where the G(P).ENVCALC instruction completes, and turns off during the next END processing.

- The following figure shows how the G(P).ENVCALC instruction operates during execution.

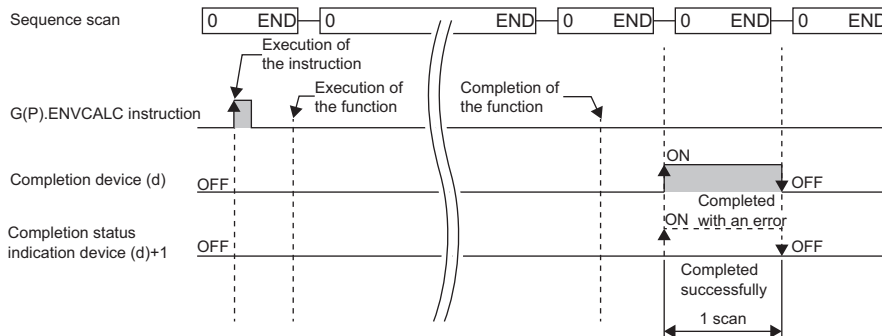

Precautions

- The input and output data type of a data analysis library that is executed by this dedicated instruction is single-precision real number; therefore, specifying double-word type for (s)+8 and (s)+9 may lead to a loss of trailing digits.
- During the execution of this dedicated instruction, neither a dedicated instruction nor an FB can be executed for the same C intelligent function module. The operation under the situation as previously noted is not guaranteed; therefore, arrange a program that executes a dedicated instruction or an FB after the completion device (d) turns on.

Operation error

Error code ((s)+1)	Description
0000H to 3FFFH	 MELSEC iQ-R C Intelligent Function Module User's Manual (Application)

When the instruction completes with an error, the completion status indication device (d)+1 turns on and an error code is stored to the completion status (s)+1.

FFT spectrum operation

G(P). FFTSPECT

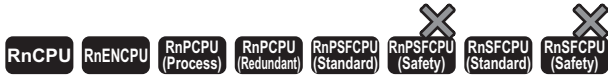

• RD55UP06-V with the firmware version "07" or later is available. For an engineering tool, version "1.050C" or later is available.

This instruction performs spectrum calculation using fast Fourier transform (FFT) for the specified wave.

Ladder	ST
	<pre>ENO:=G_FFTSPECT(EN,U,s,d); ENO:=GP_FFTSPECT(EN,U,s,d);</pre>

FBD/LD

Execution condition

Instruction	Execution condition
G.FFTSPECT	
GP.FFTSPECT	

Setting data

Description, range, data type

Operand	Description	Range	Data type	Data type (label)
(U)	Start I/O number (first three digits in four-digit hexadecimal representation) of a module	00H to FEH	16-bit unsigned binary	ANY16
(s)	Start device where control data is stored	Page 503 Control data	Device name	ANY16 ^{*1}
(d)	Device that turns on for one scan upon completion of the instruction When the instruction completes with an error, (d)+1 also turns on.	—	Bit	ANYBIT_ARRAY (Number of elements: 2)
EN	Execution condition	—	Bit	BOOL
ENO	Execution result	—	Bit	BOOL

*1 To set a data type using a label, define an array for allocating an area required for the operation first, then specify an element of the array type label.

Applicable devices

Operand	Bit	Word			Double word		Indirect specification	Constant			Others (U)
	X, Y, M, L, SM, F, B, SB, FX, FY	J□□	T, ST, C, D, W, SD, SW, FD, R, ZR, RD	U□\G□, J□□□, U3E□\(\H)G□	Z	LT, LST, LC		LZ	K	H	
(U)	—	—	○ ^{*1}	—	—	—	○	○	—	—	○
(s)	—	—	○ ^{*1}	—	—	—	○	—	—	—	—
(d)	○ ^{*2}	—	○ ^{*3}	—	—	—	—	—	—	—	—

*1 FD cannot be used.

*2 FX and FY cannot be used.

*3 T, ST, C, and FD cannot be used.

■ Control data

Operand: (s)				
Device	Item	Description	Setting range	Set by
+0	System area	—	—	—
+1	Completion status	The completion status is stored upon completion of the instruction. <ul style="list-style-type: none"> • 0: Completed successfully • Other than 0: Completed with an error (error code) 	—	System
+2 +3	Start address of input data storage destination	Specify a start address of the buffer memory of a C intelligent function module where wave data to be calculated is stored. <ul style="list-style-type: none"> • Data for the specified number of data points is read from the specified start address and its consecutive address in the buffer memory, and is used for operation. • Before executing this dedicated instruction, store the wave data to be calculated in the buffer memory. 	16384 to 2097151	User
+4 +5	Number of data points	Specify the number of array elements of wave data to be operated.	16 to 32768	User
+6 +7	Window type	Specify a window function used for fast Fourier transform (FFT). <ul style="list-style-type: none"> • 0: Rectangular window • 1: Hanning window • 2: Hamming window • 3: Blackman window 	0 to 3	User
+8 +9	Spectrum format	Specify an output spectrum format for fast Fourier transform (FFT). <ul style="list-style-type: none"> • 0: Power • 1: P (Peak) • 2: P-P (Peak to Peak) • 3: RMS (Root Mean Square) 	0 to 3	User
+10 +11	Start address of output data	Specify a start address of the buffer memory of a C intelligent function module to store an operation result. <ul style="list-style-type: none"> • Data for the specified the number of data points is stored to the specified start address and its consecutive address in the buffer memory as an operation result. 	16384 to 2097151	User
+12 +13	Wave data type selection	Specify a data type of the wave to be analyzed. <ul style="list-style-type: none"> • 0: Word [signed] • 1: Double word [signed] • 2: Single-precision real number 	0 to 2	User
+14 +15	Output spectrum data type selection	Specify the data type of an analysis result (spectrum). <ul style="list-style-type: none"> • 0: Word [signed] • 1: Double word [signed] • 2: Single-precision real number 	0 to 2	User

Processing details

- For the C intelligent function module specified to (U), the data analysis function (DANL_FFTSpectrum) for C intelligent function modules is called using a value specified to (s). The result is stored to the buffer memory specified to (s)+10 and (s)+11 and its consecutive address.
- The fast Fourier transform (FFT) is performed for the wave data specified to the start address of input data storage destination to perform spectrum calculation. When the number of data points of the specified wave data is other than the power of 2, a discrete Fourier transform (DFT) is applied, and as a result, the execution speed is slower than fast Fourier transform (FFT).
- By performing the fast Fourier transform (FFT), the time axis of wave data is converted to a frequency axis.

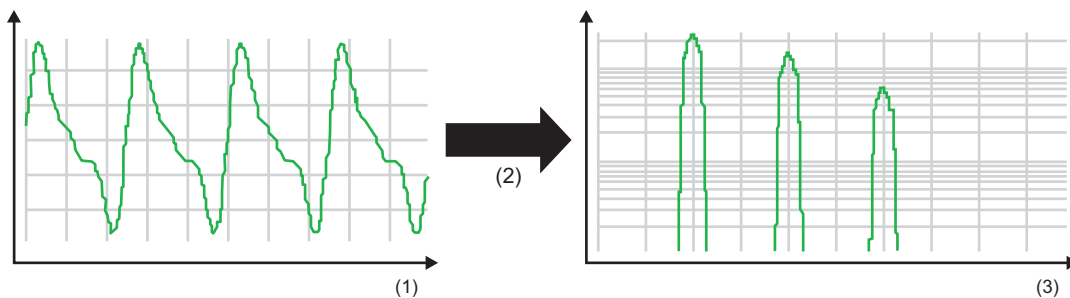

- (1) Time
(2) FFT operation
(3) Frequency

- Wave data for fast Fourier transform (FFT) is read from the buffer memory address specified for the start address of input data storage destination for the specified number of data points. For the buffer memory address specified for the start address of input data storage destination and its consecutive address, data for the specified number of data points should be stored in advance.
- Data for the specified number of data points is stored to the buffer memory address specified for the start address of output data and its consecutive address as an operation result. For the buffer memory address specified for the start address of output data and its consecutive address, reserve an area larger than or equal to the specified number of data points.
- This dedicated instruction supports window functions, such as rectangular, hanning, hamming, and blackman.
- This dedicated instruction supports output spectrum formats, such as power, P (Peak), P-P (Peak to Peak), and RMS (root mean square).

- This instruction uses buffer memory for input data and an operation result.

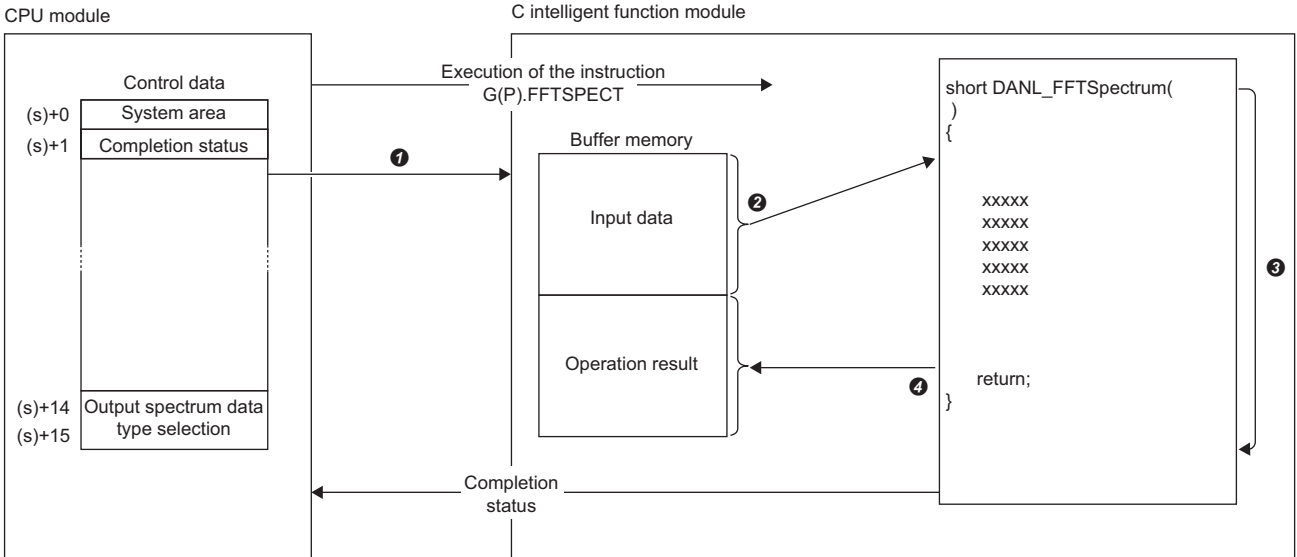

- ❶ A value specified in the control data is passed to a C intelligent function module.
- ❷ Data for the same number of points specified for the number of data points is read from the buffer memory.
- ❸ The data analysis function (DANL_FFTSpectrum) is executed.
- ❹ Data for the same number of points specified for the number of data points is written to the buffer memory.

Item	Description
Input data	From the buffer memory address specified to (s)+2 and (s)+3, data for the same size specified to (s)+4 and (s)+5 is calculated. Before executing this dedicated instruction, store the wave data to be calculated in the buffer memory.
Operation result	From the buffer memory address specified to (s)+10 and (s)+11, data for the same size specified to (s)+4 and (s)+5 is stored as an operation result.

- The completion status of the G(P).FFTSPECT instruction can be checked with the completion device (d) and the completion status indication device (d)+1.

- Completion device (d)

This device turns on during END processing of the scan where the G(P).FFTSPECT instruction completes, and turns off during the next END processing.

- Completion status indication device (d)+1

When completed successfully: The device remains off.

When completed with an error: This device turns on during END processing of the scan where the G(P).FFTSPECT instruction completes, and turns off during the next END processing.

- The following figure shows how the G(P).FFTSPECT instruction operates during execution.

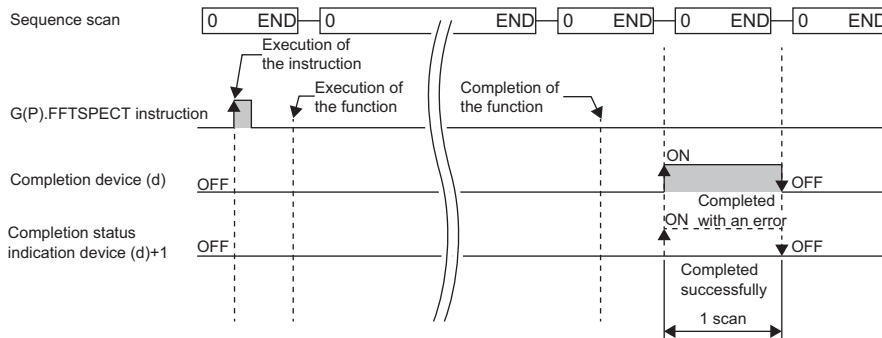

Precautions

- The input and output data type of a data analysis library that is executed by this dedicated instruction is single-precision real number; therefore, specifying double-word type for (s)+12 and (s)+13 may lead to a loss of trailing digits.
- During the execution of this dedicated instruction, neither a dedicated instruction nor an FB can be executed for the same C intelligent function module. The operation under the situation as previously noted is not guaranteed; therefore, arrange a program that executes a dedicated instruction or an FB after the completion device (d) turns on.

Operation error

Error code ((s)+1)	Description
0000H to 3FFFH	 MELSEC iQ-R C Intelligent Function Module User's Manual (Application)

When the instruction completes with an error, the completion status indication device (d)+1 turns on and an error code is stored to the completion status (s)+1.

13.3 Statistical Analysis Function Execution Instruction

Least-squares operation

G(P).LEASTSQ



• RD55UP06-V with the firmware version "07" or later is available. For an engineering tool, version "1.050C" or later is available.

This instruction calculates a coefficient and a constant of a polynomial, and a multiple correlation coefficient using a least-squares method for the specified array.

Ladder	ST
	<pre>ENO:=G_LEASTSQ(EN,U,s,d); ENO:=GP_LEASTSQ(EN,U,s,d);</pre>

FBD/LD

Execution condition

Instruction	Execution condition
G.LEASTSQ	
GP.LEASTSQ	

Setting data

Description, range, data type

Operand	Description	Range	Data type	Data type (label)
(U)	Start I/O number (first three digits in four-digit hexadecimal representation) of a module	00H to FEH	16-bit unsigned binary	ANY16
(s)	Start device where control data is stored	Page 508 Control data	Device name	ANY16 ^{*1}
(d)	Device that turns on for one scan upon completion of the instruction When the instruction completes with an error, (d)+1 also turns on.	—	Bit	ANYBIT_ARRAY (Number of elements: 2)
EN	Execution condition	—	Bit	BOOL
ENO	Execution result	—	Bit	BOOL

*1 To set a data type using a label, define an array for allocating an area required for the operation first, then specify an element of the array type label.

■Applicable devices

Operand	Bit		Word			Double word		Indirect specification	Constant			Others (U)
	X, Y, M, L, SM, F, B, SB, FX, FY	J□□	T, ST, C, D, W, SD, SW, FD, R, ZR, RD	U□VG□, J□□, U3E□(H)G□	Z	LT, LST, LC	LZ		K, H	E	\$	
(U)	—	—	○*1	—	—	—	○	○	—	—	○	
(s)	—	—	○*1	—	—	—	○	—	—	—	—	
(d)	○*2	—	○*3	—	—	—	—	—	—	—	—	

*1 FD cannot be used.

*2 FX and FY cannot be used.

*3 T, ST, C, and FD cannot be used.

■Control data

Operand: (s)				
Device	Item	Description	Setting range	Set by
+0	System area	—	—	—
+1	Completion status	The completion status is stored upon completion of the instruction. • 0: Completed successfully • Other than 0: Completed with an error (error code)	—	System
+2 +3	Start address of X coordinate storage destination	Specify a start address of the buffer memory of a C intelligent function module where X coordinate data to be calculated is stored. • Data for the specified number of data points is read from the specified start address and its consecutive address in the buffer memory, and is used for operation. • Before executing this dedicated instruction, store the wave data to be calculated in the buffer memory.	16384 to 2097151	User
+4 +5	Start address of Y coordinate storage destination	Specify a start address of the buffer memory of a C intelligent function module where Y coordinate data to be calculated is stored. • Data for the specified number of data points is read from the specified start address and its consecutive address in the buffer memory, and is used for operation. • Before executing this dedicated instruction, store the wave data to be calculated in the buffer memory.	16384 to 2097151	User
+6 +7	Number of data points	Specify the number of array elements of the X coordinate data and the Y coordinate data to be calculated. • Specify a value greater than or equal to the one set for the degree + 2.	3 to 500000	User
+8 +9	Degree	Specify a degree to be operated.	1 to 10	User
+10 +11	Start address of output data	Specify a start address of the buffer memory of a C intelligent function module to store an operation result. • Data for the number of points specified for (degree+1) is stored to the specified start address and its consecutive address in the buffer memory as an operation result. • An operation result is stored as a single-precision real number.	16384 to 2097150	User
+12 +13	Start address of multiple correlation coefficient output result storage destination	Specify a start address of the buffer memory of a C intelligent function module to store a multiple correlation coefficient. • Data for two words worth of data is stored to the specified start address and its consecutive address in the buffer memory as an operation result. • A multiple correlation coefficient is stored as a single-precision real number.	16384 to 2097150	User
+14 +15	Wave data type selection	Specify a data type of the wave to be analyzed. • 0: Word [signed] • 2: Single-precision real number	0, 2	User

Processing details

- For the C intelligent function module specified to (U), the data analysis function (DANL_LeastSquare) for C intelligent function modules is called using a value specified to (s). The result is stored to the buffer memory specified to (s)+10, (s)+11, (s)+12, and (s)+13 and its consecutive address.
- A least-squares method operation can be performed for an array (X axis and Y axis) specified to the X coordinate storage destination (pfDataX) and the Y coordinate storage destination (pfDataY).
- Data for a least-squares method calculation is read from the buffer memory addresses specified for the X coordinate storage destination and the Y coordinate storage destination for the specified number of data points. For the buffer memory addresses specified for the start address of X coordinate storage destination and start address of Y coordinate storage destination and their consecutive addresses, data for the specified number of data points should be stored in advance.
- An operation result is stored to the buffer memory address specified for the start address of output data and its consecutive address. For the buffer memory address specified for the start address of output data and its consecutive address, reserve an area larger than or equal to the size specified for the degree + 1 because the number of arrays in the operation result will be 'degree+1'.
- If an overflow occurs during operation, review the input data. A value stored at the occurrence of an overflow varies depending on each engineering tool. Check the specification of the engineering tool used.
- For an operation result, each coefficient is stored from the start in the order of {constant, first-order coefficient, second-order coefficient, third-order coefficient...} for the degree specified to the degree.

Ex.

When '5' is specified to the degree, the number of arrays in the operation result will be '6'. (Coefficients (a to e) and a constant (f) of a fifth-order polynomial are calculated.)

Prediction data Y to the X coordinate data can be calculated by using the operation result obtained above (coefficients (a to e) and a constant (f) of a fifth-order polynomial) and specifying an arbitrary value to 'X' in the polynomial 'Y = aX⁵ + bX⁴ + cX³ + dX² + eX + f'.

Number of array elements in the operation result*1	Data item	Corresponding coefficient
Output[0]	Constant	f
Output[1]	First-order coefficient	e
Output[2]	Second-order coefficient	d
Output[3]	Third-order coefficient	c
Output[4]	Fourth-order coefficient	b
Output[5]	Fifth-order coefficient	a

*1 nth data in the specified start address of output data is refers to as 'Output[n]'.

Prediction data Y to the X coordinate

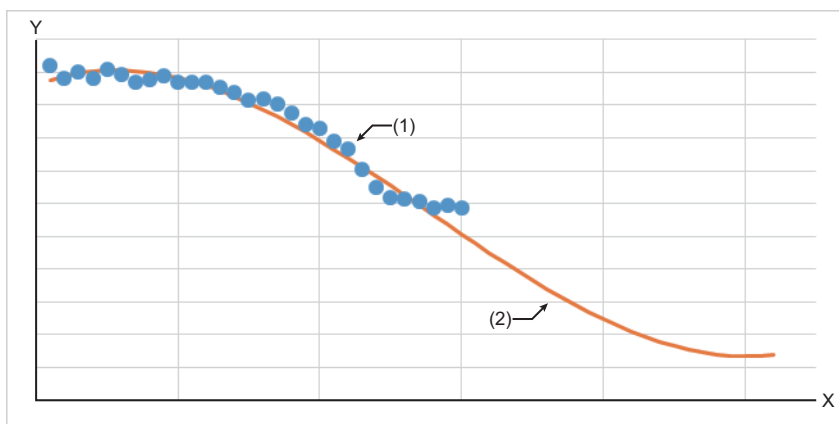

X: X axis
 Y: Y axis
 (1) Input data
 (2) Prediction data Y

- A multiple correlation coefficient has the following characteristics:
 '-1 ≥ multiple correlation coefficient ≥ 1'
 Close to 1: Positive correlation (with a straight line having a positive slope)
 Close to 0: No correlation
 Close to -1: Negative correlation (with a straight line having a negative slope)
- This instruction uses buffer memory for input data and an operation result.

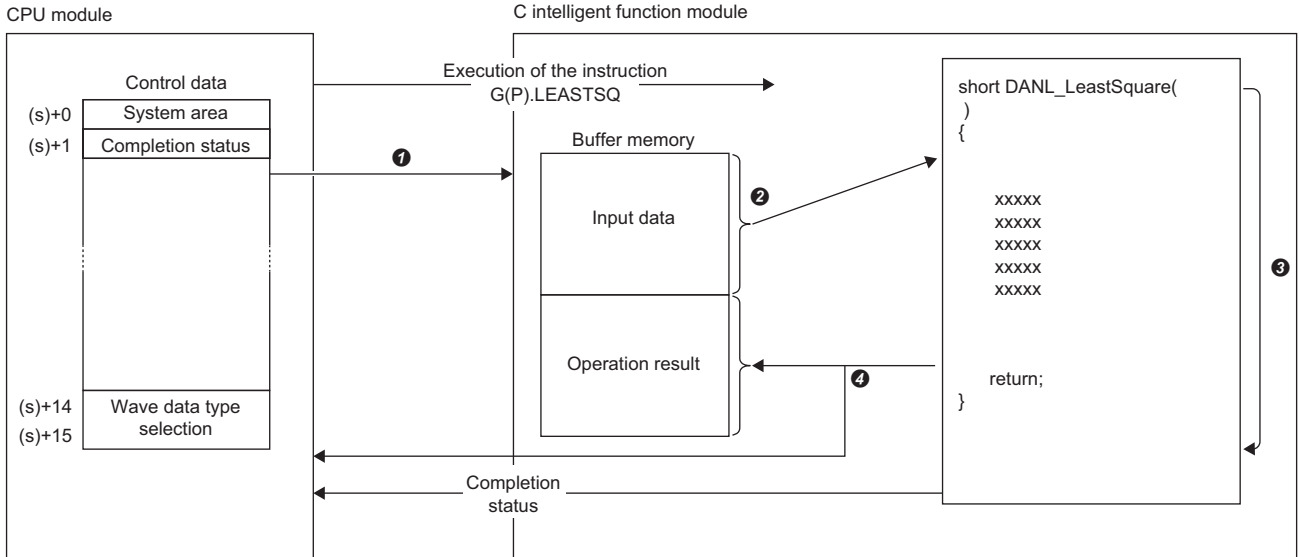

- ➊ A value specified in the control data is passed to a C intelligent function module.
- ➋ Data for the same number of points specified for the number of data points is read from the buffer memory.
- ➌ The statistical analysis function (DANL_LeastSquare) is executed.
- ➍ The operation result is written to the buffer memory of the C intelligent function module and devices in the CPU module.

Item	Description
Input data	From the buffer memory address specified to (s)+2, (s)+3, (s)+4, and (s)+5, data for the same size specified to (s)+6 and (s)+7 is calculated. Before executing this dedicated instruction, store the wave data to be calculated in the buffer memory.
Operation result	Operation results are stored to each of the following storage destinations. <ul style="list-style-type: none"> • From the buffer memory address specified to (s)+10 and (s)+11, data for the same size specified to (s)+8 and (s)+9 plus one point (number of points of degree + 1 point) is stored as an operation result. • An operation result (multiple correlation coefficient) is stored for two words worth of data from the buffer memory address specified for (s)+12 and (s)+13.

- The completion status of the G(P).LEASTSQ instruction can be checked with the completion device (d) and the completion status indication device (d)+1.

- Completion device (d)

This device turns on during END processing of the scan where the G(P).LEASTSQ instruction completes, and turns off during the next END processing.

- Completion status indication device (d)+1

When completed successfully: The device remains off.

When completed with an error: This device turns on during END processing of the scan where the G(P).LEASTSQ instruction completes, and turns off during the next END processing.

- The following figure shows how the G(P).LEASTSQ instruction operates during execution.

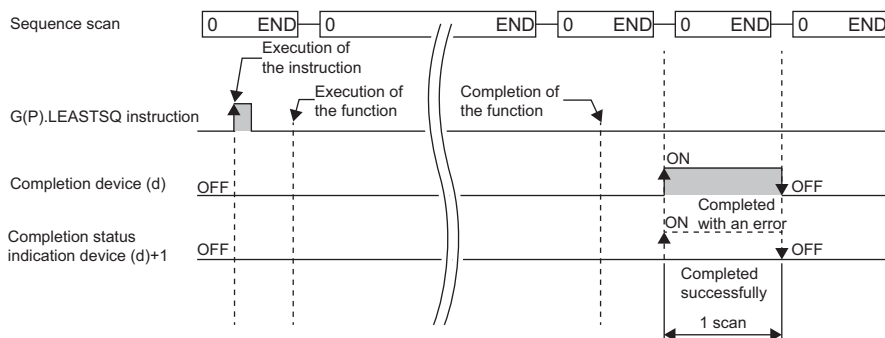

Precautions

During the execution of this dedicated instruction, neither a dedicated instruction nor an FB can be executed for the same C intelligent function module. The operation under the situation as previously noted is not guaranteed; therefore, arrange a program that executes a dedicated instruction or an FB after the completion device (d) turns on.

Operation error

Error code ((s)+1)	Description
0000H to 3FFFH	 MELSEC IQ-R C Intelligent Function Module User's Manual (Application)

When the instruction completes with an error, the completion status indication device (d)+1 turns on and an error code is stored to the completion status (s)+1.

Determination of unit space

G(P).MTUNIT

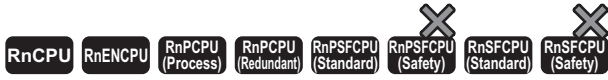

• RD55UP06-V with the firmware version "07" or later is available. For an engineering tool, version "1.050C" or later is available.

This instruction determines a unit space that is used in the MT method based on the specified normal data.

Ladder	ST
	<pre>ENO:=G_MTUNIT(EN,U,s,d); ENO:=GP_MTUNIT(EN,U,s,d);</pre>

FBD/LD

Execution condition

Instruction	Execution condition
G.MTUNIT	
GP.MTUNIT	

Setting data

Description, range, data type

Operand	Description	Range	Data type	Data type (label)
(U)	Start I/O number (first three digits in four-digit hexadecimal representation) of a module	00H to FEH	16-bit unsigned binary	ANY16
(s)	Start device where control data is stored	Page 513 Control data	Device name	ANY16 ^{*1}
(d)	Device that turns on for one scan upon completion of the instruction When the instruction completes with an error, (d)+1 also turns on.	—	Bit	ANYBIT_ARRAY (Number of elements: 2)
EN	Execution condition	—	Bit	BOOL
ENO	Execution result	—	Bit	BOOL

*1 To set a data type using a label, define an array for allocating an area required for the operation first, then specify an element of the array type label.

Applicable devices

Operand	Bit		Word		Double word		Indirect specification	Constant			Others (U)
	X, Y, M, L, SM, F, B, SB, FX, FY	J□□□	T, ST, C, D, W, SD, SW, FD, R, ZR, RD	U□□□□, J□□□□, U3E□□(H)□□	Z	LT, LST, LC		LZ	K, H	E	
(U)	—	—	○ ^{*1}	—	—	—	○	○	—	—	○
(s)	—	—	○ ^{*1}	—	—	—	○	—	—	—	—
(d)	○ ^{*2}	—	○ ^{*3}	—	—	—	—	—	—	—	—

*1 FD cannot be used.

*2 FX and FY cannot be used.

*3 T, ST, C, and FD cannot be used.

Control data

Operand: (s)				
Device	Item	Description	Setting range	Set by
+0	System area	—	—	—
+1	Completion status	The completion status is stored upon completion of the instruction. <ul style="list-style-type: none"> • 0: Completed successfully • Other than 0: Completed with an error (error code) 	—	System
+2 +3	Start address of normal data storage destination	Specify a start address of the buffer memory of a C intelligent function module where wave data to be calculated is stored. <ul style="list-style-type: none"> • Data for the specified number of normal data items × number of normal data samples is read from the specified start address and its consecutive address in the buffer memory, and is used for operation. • Before executing this dedicated instruction, store the wave data to be calculated in the buffer memory. 	16384 to 2097151	User
+4 +5	Normal data storage destination size (byte)	Specify a size of the buffer memory of a C intelligent function module where wave data to be calculated is stored.	A value greater than or equal to the number of normal data items × number of normal data samples × number of bytes required for the data type specified for the wave data type selection	User
+6 +7	Number of normal data items	Specify the number of normal data items. <ul style="list-style-type: none"> • Specify a value less than or equal to the one set for the number of normal data samples. 	2 to 300	User
+8 +9	Number of normal data samples	Specify the number of normal data samples.	2 to 3000	User
+10 +11	Correlation matrix of a unit space output enable/disable	Specify whether or not to output the correlation matrix of a unit space. <ul style="list-style-type: none"> • 0: Not to output the correlation matrix of a unit space. • 1: Output the correlation matrix of a unit space 	0 to 1	User
+12 +13	SN ratio output enable/disable	Specify whether or not to output the SN ratio (larger-is-better characteristic) of normal data MD. <ul style="list-style-type: none"> • 0: Not to output the SN ratio (larger-is-better characteristic) of normal data MD. • 1: Output the SN ratio (larger-is-better characteristic) of normal data MD. 	0 to 1	User
+14 +15	Start address of average value output destination	Specify a start address of the buffer memory of a C intelligent function module to store an output result (average value of items). <ul style="list-style-type: none"> • Data for the specified number of normal data items is stored to the specified start address and its consecutive address in the buffer memory as an output result (average value of items). • The average value of items is stored as a single-precision real number. 	16384 to 2097150	User
+16 +17	Average value output result storage destination size (byte)	Specify a size of the buffer memory to store average values for each item in byte.	A value greater than or equal to the number of normal data items × number of bytes required for single-precision real number	User
+18 +19	Start address of standard deviation output destination	Specify a start address of the buffer memory of a C intelligent function module to store an output result (standard deviation of each item). <ul style="list-style-type: none"> • Data for the specified number of normal data items is stored to the specified start address and its consecutive address in the buffer memory as an output result (standard deviation of items). • The standard deviation of items is stored as a single-precision real number. 	16384 to 2097150	User
+20 +21	Standard deviation output result storage destination size (byte)	Specify a size of the buffer memory to store standard deviations for each item in byte.	A value greater than or equal to the number of normal data items × number of bytes required for single-precision real number	User

Operand: (s)				
Device	Item	Description	Setting range	Set by
+22 +23	Start address of inverse matrix output destination	Specify a start address of the buffer memory of a C intelligent function module to store an output result (inverse matrix of correlation matrix of a unit space). <ul style="list-style-type: none"> Data for the square of the specified number of normal data items is stored to the specified start address and its consecutive address in the buffer memory as an output result (inverse matrix of the correlation matrix of a unit space). The inverse matrix of the correlation matrix of a unit space is stored as a single-precision real number. 	16384 to 2097150	User
+24 +25	Inverse matrix output result storage destination size (byte)	Specify a size of the buffer memory to store the inverse matrix of the correlation matrix of a unit space in byte.	A value greater than or equal to the square of the number of normal data items × number of bytes required for single-precision real number	User
+26 +27	Start address of normal data MD output destination	Specify a start address of the buffer memory of a C intelligent function module to store an output result (Mahalanobis distance of normal data). <ul style="list-style-type: none"> Data for the specified number of normal data samples is stored to the specified start address and its consecutive address in the buffer memory as an output result (Mahalanobis distance of normal data). The Mahalanobis distance of normal data is stored as a single-precision real number. 	16384 to 2097150	User
+28 +29	Normal data MD output result storage destination size (byte)	Specify a size of the buffer memory to store the Mahalanobis distance of normal data in byte.	A value greater than or equal to the number of normal data samples × number of bytes required for single-precision real number	User
+30 +31	Start address of correlation matrix output destination	Specify a start address of the buffer memory of a C intelligent function module to store an output result (correlation matrix of a unit space). <ul style="list-style-type: none"> Data for the square of the specified number of normal data items is stored to the specified start address and its consecutive address in the buffer memory as an output result (correlation matrix of a unit space). The correlation matrix of a unit space is output when 'Correlation matrix of a unit space output enable/disable' is '1'. It is not output when the value is '0'. The correlation matrix of a unit space is stored as a single-precision real number. 	16384 to 2097150	User
+32 +33	Correlation matrix output result storage destination size (byte)	Specify a size of the buffer memory to store the correlation matrix of a unit space in byte.	A value greater than or equal to the square of the number of normal data items × number of bytes required for single-precision real number	User
+34 +35	Start address of normal data MD average value storage destination	Specify a start address of the buffer memory of a C intelligent function module to store the average value of a Mahalanobis distance. <ul style="list-style-type: none"> Data for two words worth of data is stored to the specified start address and its consecutive address in the buffer memory as an output result. The average value of a Mahalanobis distance is stored as a single-precision real number. 	16384 to 2097150	User
+36 +37	Start address of the SN ratio (larger-is-better characteristic) of normal data MD storage destination	Specify a start address of the buffer memory of a C intelligent function module to store the SN ratio (larger-is-better characteristic) of normal data MD. <ul style="list-style-type: none"> When 'SN ratio output enable/disable' is '1', the SN ratio (larger-is-better characteristic) of a Mahalanobis distance is returned. (No result is returned when it is '0'.) Data for two words worth of data is stored to the specified start address and its consecutive address in the buffer memory as an output result. An SN ratio (larger-is-better characteristic) of normal data MD is stored as a single-precision real number. 	16384 to 2097150	User
+38 +39	Wave data type selection	Specify a data type of the wave to be analyzed. <ul style="list-style-type: none"> 0: Word [signed] 1: Double word [signed] 2: Single-precision real number 	0 to 2	User

Processing details

- For the C intelligent function module specified to (U), the data analysis function (DANL_MTUnit) for C intelligent function modules is called using a value specified to (s). The result is stored to the buffer memory specified to (s)+14, (s)+15, (s)+18, (s)+19, (s)+22, (s)+23, (s)+26, (s)+27, (s)+30, (s)+31, (s)+34, (s)+35, (s)+36, and (s)+37 and its consecutive address.
 - This function determines a unit space^{*1} that is used in the MT method based on the specified normal data.
- *1 In a unit space, a correlation matrix and its inverse matrix, which are created based on normal data, are included.
- Besides determination of a unit space, the following data can also be obtained with this dedicated instruction. Average values for each item, Standard deviations for each item, Mahalanobis distances for each sample, Average value of a Mahalanobis distance, SN ratio (larger-is-better characteristic)
 - Normal data is read for the number of units of data specified to the normal data items × number of normal data samples from the buffer memory address specified for the start address of input data storage destination. For the buffer memory address specified to the start address of input data storage destination and its consecutive address, data for the specified number of normal data items × number of normal data samples should be stored in advance.

Ex.

Number of normal data samples: 100 samples, number of normal data items: 10 items

(Hereafter, nth data in the buffer memory address specified to the start address of input data storage destination and its consecutive address refers to as 'Data[n]'.)

	(1)	(2)				
	1	1	2	3	~	10
(3)	1	Data[0]	Data[1]	Data[2]	~	Data[9]
	2	Data[10]	Data[11]	Data[12]	~	Data[19]
	~	~	~	~	~	~
	100	Data[990]	Data[991]	Data[992]	~	Data[999]

- (1) Number of data points
- (2) Number of normal data items
- (3) Number of normal data samples

- When 'SN ratio output enable/disable' is '1', a calculation result is output to the buffer memory address specified for the start address of the SN ratio (larger-is-better characteristic) of normal data MD storage destination and its consecutive address. The larger SN ratio (larger-is-better characteristic) corresponds to the better performance characteristic.
- If some items are strongly related to one another, an inverse matrix may not be calculated correctly and this is called multicollinearity. If it occurs, the processing will be interrupted and an error will be returned.
- The calculation result of the average value of a Mahalanobis distance is stored to the buffer memory specified for the start address of normal data MD average value storage destination. If the value is not an approximate value of 1, a multiple collinearity error may occur. In that case, however, it is not regarded as an error.
- When a unit space is determined successfully based on sufficient number of samples without having a multicollinearity error, the average value of a Mahalanobis distance will be '1'. If a Mahalanobis distance of input data is calculated using an output result (inverse matrix of correlation matrix) other than '1', an accurate result may not be obtained.
- If all the values of a specific item are the same, the standard deviation of the item will be '0' and therefore a Mahalanobis distance cannot be obtained. In that case, the processing will be terminated and an error will be returned.
- Before the execution of an operation, this instruction checks input values so as not to cause an overflow during operation. However, in the calculation of single-precision real numbers, an error may occur depending on the combination of input values even though the check has been conducted. In that case, review the input data. A value stored at the occurrence of an overflow varies depending on each engineering tool. Check the specification of the engineering tool used.

- This instruction uses buffer memory for input data and an operation result.

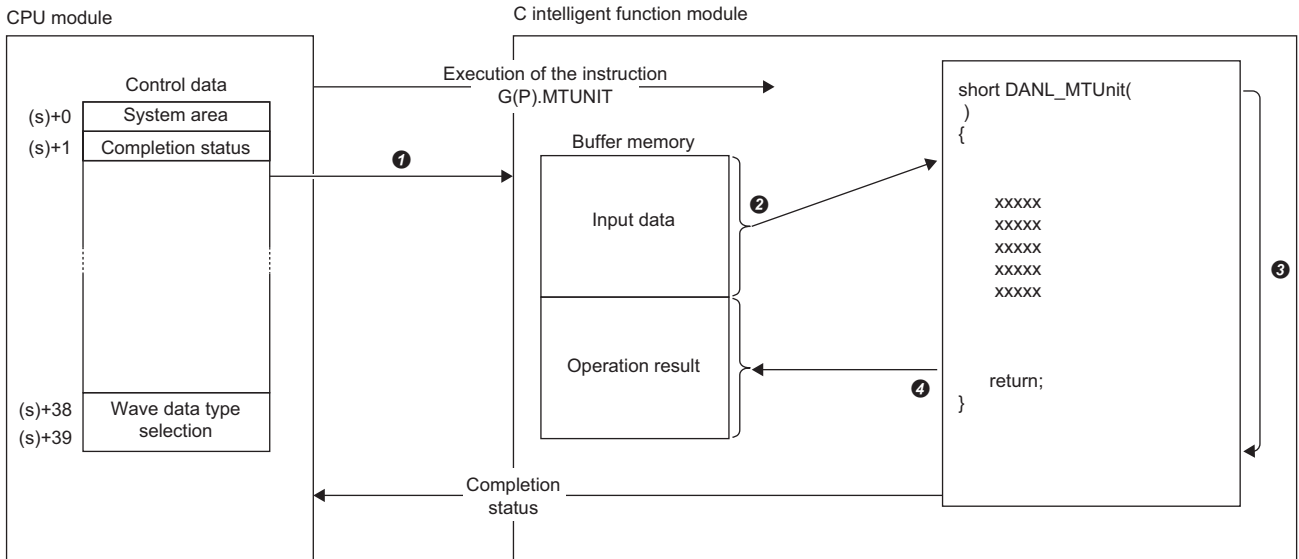

- ➊ A value specified in the control data is passed to a C intelligent function module.
- ➋ Data for the same number of points specified for the number of data points is read from the buffer memory.
- ➌ The statistical analysis function (DANL_MTUnit) is executed.
- ➍ Data for the same number of points specified for the number of data points is written to the buffer memory.

Item	Description
Input data	From the buffer memory address specified to (s)+2 and (s)+3, data for the same size specified to (s)+4 and (s)+5 is calculated. Before executing this dedicated instruction, store the wave data to be calculated in the buffer memory.
Operation result	From the buffer memory address specified to (s)+14, (s)+15, (s)+18, (s)+19, (s)+22, (s)+23, (s)+26, (s)+27, (s)+30, (s)+31, (s)+34, (s)+35, (s)+36, and (s)+37, data for the same data size specified to (s)+16, (s)+17, (s)+20, (s)+21, (s)+24, (s)+25, (s)+28, (s)+29, (s)+32, and (s)+33 is stored as an operation result.

- The completion status of the G(P).MTUNIT instruction can be checked with the completion device (d) and the completion status indication device (d)+1.

- Completion device (d)

This device turns on during END processing of the scan where the G(P).MTUNIT instruction completes, and turns off during the next END processing.

- Completion status indication device (d)+1

When completed successfully: The device remains off.

When completed with an error: This device turns on during END processing of the scan where the G(P).MTUNIT instruction completes, and turns off during the next END processing.

- The following figure shows how the G(P).MTUNIT instruction operates during execution.

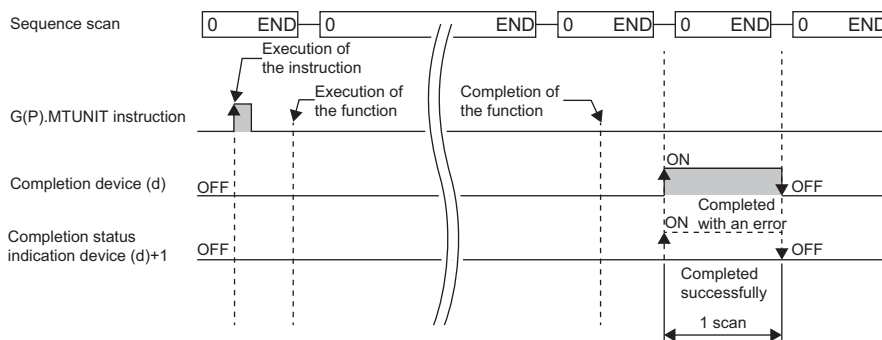

Precautions

- If the total size of input data and output data exceeds the buffer memory size (2080766 words), set the start address of input data storage destination and start address of output data storage destination so as to intentionally overlap each other.
- The input and output data type of a data analysis library that is executed by this dedicated instruction is single-precision real number; therefore, specifying double-word type for (s)+38 and (s)+39 may lead to a loss of trailing digits.
- During the execution of this dedicated instruction, neither a dedicated instruction nor an FB can be executed for the same C intelligent function module. The operation under the situation as previously noted is not guaranteed; therefore, arrange a program that executes a dedicated instruction or an FB after the completion device (d) turns on.

Operation error

Error code ((s)+1)	Description
0000H to 3FFFH	 MELSEC iQ-R C Intelligent Function Module User's Manual (Application)

When the instruction completes with an error, the completion status indication device (d)+1 turns on and an error code is stored to the completion status (s)+1.

Mahalanobis distance calculation of signal data

G(P).MTMD

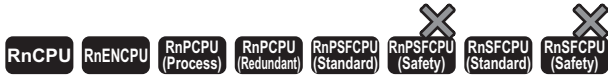

• RD55UP06-V with the firmware version "07" or later is available. For an engineering tool, version "1.050C" or later is available.

This function calculates a Mahalanobis distance of the specified input data.

Ladder	ST
	<pre>ENO:=G_MTMD(EN,U,s,d); ENO:=GP_MTMD(EN,U,s,d);</pre>

FBD/LD

Execution condition

Instruction	Execution condition
G.MTMD	
GP.MTMD	

Setting data

Description, range, data type

Operand	Description	Range	Data type	Data type (label)
(U)	Start I/O number (first three digits in four-digit hexadecimal representation) of a module	00H to FEH	16-bit unsigned binary	ANY16
(s)	Start device where control data is stored	Page 519 Control data	Device name	ANY16 ^{*1}
(d)	Device that turns on for one scan upon completion of the instruction When the instruction completes with an error, (d)+1 also turns on.	—	Bit	ANYBIT_ARRAY (Number of elements: 2)
EN	Execution condition	—	Bit	BOOL
ENO	Execution result	—	Bit	BOOL

*1 To set a data type using a label, define an array for allocating an area required for the operation first, then specify an element of the array type label.

Applicable devices

Operand	Bit	Word			Double word		Indirect specification	Constant			Others (U)
	X, Y, M, L, SM, F, B, SB, FX, FY	J□□□	T, ST, C, D, W, SD, SW, FD, R, ZR, RD	U□□□□, J□□□□, U3E□□(H)G□□	Z	LT, LST, LC		LZ	K, H	E	
(U)	—	—	○ ^{*1}	—	—	—	○	○	—	—	○
(s)	—	—	○ ^{*1}	—	—	—	○	—	—	—	—
(d)	○ ^{*2}	—	○ ^{*3}	—	—	—	—	—	—	—	—

*1 FD cannot be used.

*2 FX and FY cannot be used.

*3 T, ST, C, and FD cannot be used.

Control data

Operand: (s)				
Device	Item	Description	Setting range	Set by
+0	System area	—	—	—
+1	Completion status	The completion status is stored upon completion of the instruction. <ul style="list-style-type: none"> • 0: Completed successfully • Other than 0: Completed with an error (error code) 	—	System
+2 +3	Start address of input data storage destination	Specify a start address of the buffer memory of a C intelligent function module where wave data to be calculated is stored. <ul style="list-style-type: none"> • Data for the specified number of input data items × number of input data samples is read from the specified start address and its consecutive address in the buffer memory, and is used for operation. • Before executing this dedicated instruction, store the wave data to be calculated in the buffer memory. 	16384 to 2097151	User
+4 +5	Input data storage destination size (byte)	Specify a size of the buffer memory of a C intelligent function module where wave data to be calculated is stored.	A value greater than or equal to the number of input data items × number of input data samples × number of bytes required for the wave data type selection	User
+6 +7	Number of input data items	Specify the number of data items to be calculated. <ul style="list-style-type: none"> • Set the same value as the one set for the number of normal data items in G(P).MTUNIT. 	2 to 300	User
+8 +9	Number of input data samples	Specify the number of input data samples to be calculated.	1 to 3000	User
+10 +11	Contribution level output enable/disable	Specify whether or not to output a contribution level. <ul style="list-style-type: none"> • 0: Not to output a contribution level. • 1: Output a contribution level. 	0 to 1	User
+12 +13	SN ratio output enable/disable	Specify whether or not to output the SN ratio (larger-is-better characteristic) of input data MD. <ul style="list-style-type: none"> • 0: Not to output the SN ratio (larger-is-better characteristic) of input data MD. • 1: Output the SN ratio (larger-is-better characteristic) of input data MD. 	0 to 1	User
+14 +15	Start address of average value storage destination	Specify a start address of the buffer memory of a C intelligent function module where an average value is stored. <ul style="list-style-type: none"> • Data for the specified number of input data items is read from the specified start address and its consecutive address in the buffer memory, and is used for operation. • Before executing this dedicated instruction, store the wave data to be calculated in the buffer memory. • The average value of items obtained by the G(P). MTUNIT instruction should be stored. 	16384 to 2097150	User
+16 +17	Average value storage destination size (byte)	Specify the size of the buffer memory where the average value of normal data is stored.	A value greater than or equal to the number of input data items × number of bytes required for single-precision real number	User
+18 +19	Start address of standard deviation storage destination	Specify a start address of the buffer memory of a C intelligent function module where a standard deviation is stored. <ul style="list-style-type: none"> • Data for the specified number of input data items is read from the specified start address and its consecutive address in the buffer memory, and is used for operation. • Before executing this dedicated instruction, store the wave data to be calculated in the buffer memory. • Store the value of a standard deviation obtained by the G(P). MTUNIT instruction. 	16384 to 2097150	User
+20 +21	Standard deviation storage destination size (byte)	Specify a size of the buffer memory where the standard deviation of normal data is stored.	A value greater than or equal to the number of input data items × number of bytes required for single-precision real number	User

Operand: (s)				
Device	Item	Description	Setting range	Set by
+22 +23	Start address of inverse matrix storage destination	Specify a start address of the buffer memory of a C intelligent function module where wave data to be calculated is stored. <ul style="list-style-type: none"> Data for the square of the specified number of input data items is read from the specified start address and its consecutive address in the buffer memory, and is used for operation. Before executing this dedicated instruction, store the wave data to be calculated in the buffer memory. Store the value of an inverse matrix obtained by the G(P). MTUNIT instruction. 	16384 to 2097150	User
+24 +25	Inverse matrix storage destination size (byte)	Specify the size of the buffer memory where the inverse matrix of the correlation matrix of a unit space is stored.	A value greater than or equal to the square of the number of input data items × number of bytes required for single-precision real number	User
+26 +27	Start address of input data MD output destination	Specify a start address of the buffer memory of a C intelligent function module to store an output result (Mahalanobis distance of input data). <ul style="list-style-type: none"> Data for the specified number of input data samples is stored to the specified start address and its consecutive address in the buffer memory as an output result (Mahalanobis distance of input data). A Mahalanobis distance of input data is stored as a single-precision real number. 	16384 to 2097150	User
+28 +29	Input data MD output result storage destination size (byte)	Specify a size of the buffer memory to store an output result (Mahalanobis distance of the input data).	A value greater than or equal to the number of input data samples × number of bytes required for single-precision real number	User
+30 +31	Start address of contribution level output destination	Specify a start address of the buffer memory of a C intelligent function module to store an output result (contribution level). <ul style="list-style-type: none"> Data for the specified number of input data items × input data samples is stored to the specified start address and its consecutive address in the buffer memory as an output result (contribution level). A contribution level is stored as a single-precision real number. 	16384 to 2097150	User
+32 +33	Contribution level output result storage destination size (byte)	Specify a size of the buffer memory to store an output result (contribution level).	A value greater than or equal to the number of input data items × number of input data samples × number of bytes required for single-precision real number	User
+34 +35	SN ratio (larger-is-better characteristic) of input data MD output result storage destination start address	Specify a start address of the buffer memory of a C intelligent function module to store an output result (SN ratio (larger-is-better characteristic) of input data MD). <ul style="list-style-type: none"> A value is stored only when 'SN ratio output enable/disable' is '1'. Data for two words worth of data is stored to the specified start address and its consecutive address in the buffer memory as an output result. An SN ratio (larger-is-better characteristic) of input data MD is stored as a single-precision real number. 	16384 to 2097150	User
+36 +37	Wave data type selection	Specify a data type of the wave to be analyzed. <ul style="list-style-type: none"> 0: Word [signed] 1: Double word [signed] 2: Single-precision real number 	0 to 2	User

Processing details

- For the C intelligent function module specified to (U), the data analysis function (DANL_MTMahalanobisDistance) for C intelligent function modules is called using a value specified to (s). The result is stored to the buffer memory specified to (s)+26, (s)+27, (s)+30, (s)+31, (s)+34, and (s)+35 and its consecutive address.
 - A Mahalanobis distance of the specified input data can be obtained.
 - Mahalanobis distances of input data^{*1} for each sample are calculated.
- *1 Input data indicates data to check the error level. The distance between the data and a unit space is calculated as a Mahalanobis distance.
- Besides calculation of a Mahalanobis distance, the following data can also be obtained with this dedicated instruction. Contribution levels for each item, SN ratio (larger-is-better characteristic)
 - By comparing contribution levels of each item, an error cause can be assumed.
 - When 'SN ratio output enable/disable' is '1', a calculation result is output to the buffer memory address specified for the start address of the SN ratio (larger-is-better characteristic) of input data MD output result storage destination and its consecutive address. The larger SN ratio (larger-is-better characteristic) corresponds to the better performance characteristic.
 - Input data for calculating a Mahalanobis distance is read from the buffer memory address specified for the start address of input data storage destination for the specified number of input data items × number of input data samples. For the buffer memory address specified for the start address of input data storage destination and its consecutive address, data for the specified normal data items × number of normal data samples should be stored in advance.

Ex.

Number of input data samples: 100 samples, number of input data items: 10 items

(Hereafter, nth data in the buffer memory address specified to the start address of input data storage destination and its consecutive address refers to as 'Data[n]'.)

		(1)				
		1	2	3	~	10
(2) {	1	Data[0]	Data[1]	Data[2]	~	Data[9]
	2	Data[10]	Data[11]	Data[12]	~	Data[19]
	~	~	~	~	~	~
	100	Data[990]	Data[991]	Data[992]	~	Data[999]

(1) Number of input data items

(2) Number of input data samples

- If the values of the inverse matrix of the correlation matrix of a unit space are all '0', the processing will be interrupted and an error will be returned.
- If '0' is included in the standard deviation of items, the processing will be interrupted and an error will be returned.
- Before the execution of an operation, this instruction checks input values so as not to cause an overflow during operation. However, in the calculation of single-precision real numbers, an error may occur depending on the combination of input values even though the check has been conducted. In that case, review the input data. A value stored at the occurrence of an overflow varies depending on each engineering tool. Check the specification of the engineering tool used.

- This instruction uses buffer memory for input data and an operation result.

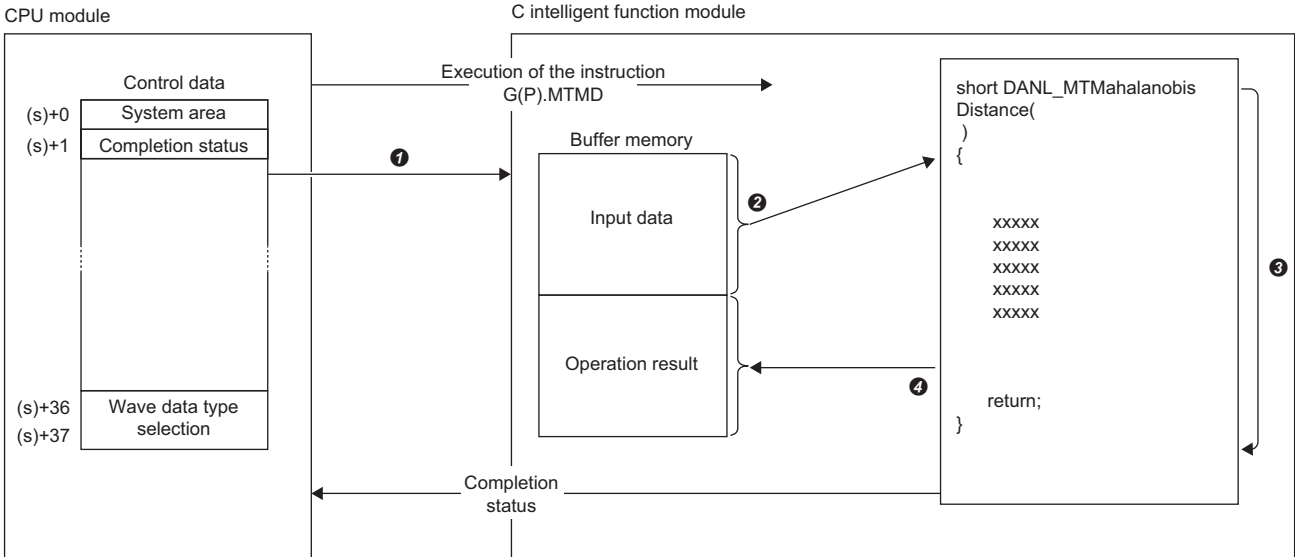

- ❶ A value specified in the control data is passed to a C intelligent function module.
- ❷ Data for the same number of points specified for the number of data points is read from the buffer memory.
- ❸ The statistical analysis function (DANL_MTMahalanobisDistance) is executed.
- ❹ Data for the same number of points specified for the number of data points is written to the buffer memory.

Item	Description
Input data	From the buffer memory address specified to (s)+2 and (s)+3, data for the same size specified to (s)+4 and (s)+5 is calculated. Before executing this dedicated instruction, store the wave data to be calculated in the buffer memory.
Operation result	From the buffer memory address specified to (s)+26, (s)+27, (s)+30, (s)+31, (s)+34, and (s)+35, data for the same data size specified to (s)+28, (s)+29, (s)+32, and (s)+33 is stored as an operation result.

- The completion status of the G(P).MTMD instruction can be checked with the completion device (d) and the completion status indication device (d)+1.

- Completion device (d)

This device turns on during END processing of the scan where the G(P).MTMD instruction completes, and turns off during the next END processing.

- Completion status indication device (d)+1

When completed successfully: The device remains off.

When completed with an error: This device turns on during END processing of the scan where the G(P).MTMD instruction completes, and turns off during the next END processing.

- The following figure shows how the G(P).MTMD instruction operates during execution.

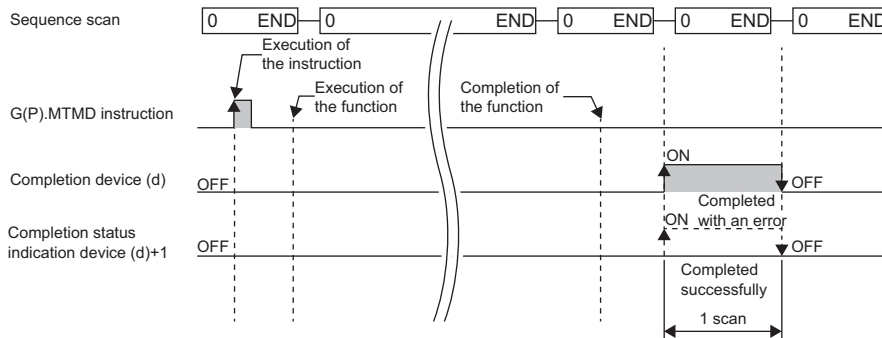

Precautions

- If the total size of input data and output data exceeds the buffer memory size (2080766 words), set the start address of input data storage destination and start address of output data storage destination so as to intentionally overlap each other.
- The input and output data type of a data analysis library that is executed by this dedicated instruction is single-precision real number; therefore, specifying double-word type for (s)+36 and (s)+37 may lead to a loss of trailing digits.
- During the execution of this dedicated instruction, neither a dedicated instruction nor an FB can be executed for the same C intelligent function module. The operation under the situation as previously noted is not guaranteed; therefore, arrange a program that executes a dedicated instruction or an FB after the completion device (d) turns on.

Operation error

Error code ((s)+1)	Description
0000H to 3FFFH	 MELSEC iQ-R C Intelligent Function Module User's Manual (Application)

When the instruction completes with an error, the completion status indication device (d)+1 turns on and an error code is stored to the completion status (s)+1.

Multiple regression analysis

G(P).MULTIRG



• RD55UP06-V with the firmware version "07" or later is available. For an engineering tool, version "1.050C" or later is available.

This function calculates a coefficient, constant, and regression statistics for multiple regression analysis.

Ladder	ST
	<pre>ENO:=G_MULTIRG(EN,U,s,d); ENO:=GP_MULTIRG(EN,U,s,d);</pre>

FBD/LD

Execution condition

Instruction	Execution condition
G.MULTIRG	
GP.MULTIRG	

Setting data

Description, range, data type

Operand	Description	Range	Data type	Data type (label)
(U)	Start I/O number (first three digits in four-digit hexadecimal representation) of a module	00H to FEH	16-bit unsigned binary	ANY16
(s)	Start device where control data is stored	Page 525 Control data	Device name	ANY16 ^{*1}
(d)	Device that turns on for one scan upon completion of the instruction When the instruction completes with an error, (d)+1 also turns on.	—	Bit	ANYBIT_ARRAY (Number of elements: 2)
EN	Execution condition	—	Bit	BOOL
ENO	Execution result	—	Bit	BOOL

*1 To set a data type using a label, define an array for allocating an area required for the operation first, then specify an element of the array type label.

Applicable devices

Operand	Bit		Word		Double word		Indirect specification	Constant			Others (U)
	X, Y, M, L, SM, F, B, SB, FX, FY	J□□	T, ST, C, D, W, SD, SW, FD, R, ZR, RD	U□□□, J□□□, U3E□(H)□□	Z	LT, LST, LC		LZ	K, H	E	
(U)	—	—	○	—	—	—	○	○	—	—	○
(s)	—	—	○ ^{*1}	—	—	—	○	—	—	—	—
(d)	○ ^{*2}	—	○ ^{*3}	—	—	—	—	—	—	—	—

*1 FD cannot be used.

*2 FX and FY cannot be used.

*3 T, ST, C, and FD cannot be used.

Control data

Operand: (s)				
Device	Item	Description	Setting range	Set by
+0	System area	—	—	—
+1	Completion status	The completion status is stored upon completion of the instruction. <ul style="list-style-type: none"> • 0: Completed successfully • Other than 0: Completed with an error (error code) 	—	System
+2 +3	Start address of X coordinate storage destination	Specify a start address of the buffer memory of a C intelligent function module where X coordinate data to be calculated is stored. <ul style="list-style-type: none"> • Data for the specified number of data points × number of data items is read from the specified start address and its consecutive address in the buffer memory, and is used for operation. • Before executing this dedicated instruction, store the wave data to be calculated in the buffer memory. 	16384 to 2097151	User
+4 +5	X coordinate storage destination size (byte)	Specify a size of the buffer memory where X coordinate data to be calculated is stored.	A value greater than or equal to the number of data points × number of data items × number of bytes required for the data type specified for the wave data type selection	User
+6 +7	Start address of Y coordinate storage destination	Specify a start address of the buffer memory of a C intelligent function module where Y coordinate data to be calculated is stored. <ul style="list-style-type: none"> • Data for the specified number of data points is read from the specified start address and its consecutive address in the buffer memory, and is used for operation. • Before executing this dedicated instruction, store the wave data to be calculated in the buffer memory. 	16384 to 2097151	User
+8 +9	Y coordinate storage destination size (byte)	Specify a size of the buffer memory where Y coordinate data to be calculated is stored.	A value greater than or equal to the number of data points × number of bytes required for the data type specified for the wave data type selection	User
+10 +11	Number of data points	Specify the number of array elements of the X_i ($i = 0, 1, \dots, n - 1$) coordinate data and the Y coordinate data to be calculated. Any value can be specified within the following range: <ul style="list-style-type: none"> • Necessity for calculating a constant $b = '0'$: 2 to 3000 • Necessity for calculating a constant $b = '1'$: 3 to 3000 	<ul style="list-style-type: none"> • Necessity for calculating a constant $b = '0'$: A value greater than or equal to the number of data items + 1 • Necessity for calculating a constant $b = '1'$: A value greater than or equal to the number of data items + 2 	User
+12 +13	Number of data items	Specify the number of units of X coordinate data to be calculated. For example, when X coordinate data to be calculated is X_0, X_1, \dots, X_{n-1} , the number of data items will be n.	1 to 64	User
+14 +15	Necessity for calculating a constant b	Specify whether or not to calculate a constant b. <ul style="list-style-type: none"> • 0: The constant b is '0'. • 1: Calculate a constant b. 	0 to 1	User
+16 +17	Necessity for calculating regression statistics	Specify whether or not to calculate regression statistics. <ul style="list-style-type: none"> • 0: Not to calculate the regression statistics. • 1: Calculate regression statistics. Regression statistics <ul style="list-style-type: none"> • Standard error of coefficient m • Constant b standard error • Coefficient of determination • Standard error of y • F statistical value • Degree of freedom • Regression sum of squares • Residual sum of squares 	0 to 1	User
+18 +19	Start address of coefficient m storage destination	Specify a start address of the buffer memory of a C intelligent function module to store an operation result (coefficient m). <ul style="list-style-type: none"> • Data for the specified number of data items is stored to the specified start address and its consecutive address in the buffer memory as an operation result (coefficient m). • An operation result is stored as a single-precision real number. 	16384 to 2097150	User

Operand: (s)				
Device	Item	Description	Setting range	Set by
+20 +21	Coefficient m storage destination size (byte)	Specify a size of the buffer memory to store an operation result (coefficient m).	A value greater than or equal to the number of data items × number of bytes required for single-precision real number	User
+22 +23	Start address of coefficient m standard error storage destination	Specify a start address of the buffer memory of a C intelligent function module to store an operation result (coefficient m standard error). • Data for the specified number of data items is stored to the specified start address and its consecutive address in the buffer memory as an operation result (coefficient m standard error). • An operation result is stored as a single-precision real number.	16384 to 2097150	User
+24 +25	Coefficient m standard error storage destination size (byte)	Specify a size of the buffer memory to store an operation result (coefficient m standard error).	A value greater than or equal to the number of data items × number of bytes required for single-precision real number	User
+26 +27	Start address of constant b storage destination	Specify a start address of the buffer memory of a C intelligent function module to store an operation result (constant b). • An operation result is output as a single-precision real number. • Data for two words worth of data is stored to the specified start address and its consecutive address in the buffer memory as an operation result.	16384 to 2097150	User
+28 +29	Start address of constant b standard error storage destination	Specify a start address of the buffer memory of a C intelligent function module to store an operation result (constant b standard error). • An operation result is output as a single-precision real number. • Data for two words worth of data is stored to the specified start address and its consecutive address in the buffer memory as an operation result.	16384 to 2097150	User
+30 +31	Start address of coefficient of determination storage destination	Specify a start address of the buffer memory of a C intelligent function module to store an operation result (coefficient of determination). • An operation result is output as a single-precision real number. • Data for two words worth of data is stored to the specified start address and its consecutive address in the buffer memory as an operation result.	16384 to 2097150	User
+32 +33	Start address of standard error of y estimation storage destination	Specify a start address of the buffer memory of a C intelligent function module to store an operation result (standard error of y estimation). • An operation result is output as a single-precision real number. • Data for two words worth of data is stored to the specified start address and its consecutive address in the buffer memory as an operation result.	16384 to 2097150	User
+34 +35	Start address of F statistical value storage destination	Specify a start address of the buffer memory of a C intelligent function module to store an operation result (F statistical value). • An operation result is output as a single-precision real number. • Data for two words worth of data is stored to the specified start address and its consecutive address in the buffer memory as an operation result.	16384 to 2097150	User
+36 +37	Start address of degree of freedom storage destination	Specify a start address of the buffer memory of a C intelligent function module to store an operation result (degree of freedom). • An operation result is output as a single-precision real number. • Data for two words worth of data is stored to the specified start address and its consecutive address in the buffer memory as an operation result.	16384 to 2097150	User
+38 +39	Start address of regression sum of squares storage destination	Specify a start address of the buffer memory of a C intelligent function module to store an operation result (regression sum of squares). • An operation result is output as a single-precision real number. • Data for two words worth of data is stored to the specified start address and its consecutive address in the buffer memory as an operation result.	16384 to 2097150	User
+40 +41	Start address of residual sum of squares storage destination	Specify a start address of the buffer memory of a C intelligent function module to store an operation result (residual sum of squares). • An operation result is output as a single-precision real number. • Data for two words worth of data is stored to the specified start address and its consecutive address in the buffer memory as an operation result.	16384 to 2097150	User
+42 +43	Wave data type selection	Specify a data type of the wave to be analyzed. • 0: Word [signed] • 1: Double Word [signed] • 2: Single-precision real number	0 to 2	User

Processing details

- For the C intelligent function module specified to (U), the data analysis function (DANL_MultipleRegression) for C intelligent function modules is called using a value specified to (s). The result is stored to the buffer memory specified to (s)+18, (s)+19, (s)+22, (s)+23, and (s)+26 to (s)+41 and its consecutive address.
- A regression analysis is performed for a specified X coordinate array and Y coordinate array.
In the multiple regression analysis, the following formula should be applicable for X coordinate array and Y coordinate array.
 $Y = b + m_0 \times X_0 + m_1 \times X_1 + \dots + m_{n-1} \times X_{n-1}$ (b: constant, m_i : coefficient ($i = 0, 1, \dots, n-1$))
- Data for multiple regression analysis is read from the start address of X coordinate storage destination for the specified number of data items \times number of data points. As for Y coordinate, data is read from the start address of Y coordinate storage destination for the specified number of data points. Store data to the start address of X coordinate storage destination and the start address of Y coordinate storage destination as follows.

Ex.

Number of data points: 100 points, number of data items: 10 items

(Hereafter, nth data in the buffer memory address specified to the start address of X coordinate storage destination and its consecutive address refers to as 'DataX[n]', and nth data in the buffer memory address specified to the start address of Y coordinate storage destination and its consecutive address refers to as 'DataY[n].')

	Y	(1)			
		X ₀	X ₁	~	X ₉
(2) 1	DataY[0]	DataX[0]	DataX[1]	~	DataX[9]
2	DataY[10]	DataX[10]	DataX[11]	~	DataX[19]
~	~	~	~	~	~
100	DataY[99]	DataX[990]	DataX[991]	~	DataX[999]

(1) Number of data items

(2) Number of data points

- The following results can be obtained in a multiple regression analysis.

Name	Description
Coefficient m storage destination	A regression coefficient m in a multiple regression formula is stored.
Coefficient m standard error storage destination	A standard error of the coefficient m is stored.
Constant b	A constant term b in a multiple regression formula is stored.
Constant b standard error	A standard error of the constant b is stored.
Coefficient of determination	A coefficient of determination is stored. <ul style="list-style-type: none"> • Coefficient of determination = Regression sum of squares ÷ (regression sum of squares + residual sum of squares) The range of the coefficient of determination is 0 to 1, and a higher coefficient is an indicator of a better goodness of fit for the observations. (A multiple regression formula obtained by multiple regression analysis will show the relationship between data items much more precisely.)
Standard error of y estimation	A standard error of the predicted y value is stored.
F statistical value	Determine if the measured relationship between X coordinate data and Y coordinate data is obtained by coincidence.
Degree of freedom	The number of units of measured data, which was independently collected, is stored.*1 <ul style="list-style-type: none"> • Necessity for calculating a constant b = '0': Number of data points - Number of data items • Necessity for calculating a constant b = '1': Number of data points - Number of data items - 1
Regression sum of squares	A sum of squares of residuals between a mean value and a predicted value is stored.
Residual sum of squares	A sum of squares of residuals between a measured value and a predicted value is stored.

*1 In statistics, when there are n pieces of measured data that were independently collected, the group of data is referred to as 'degree of freedom n'. The word 'independently' means that a precise value cannot be obtained from any measured value using other measured values.

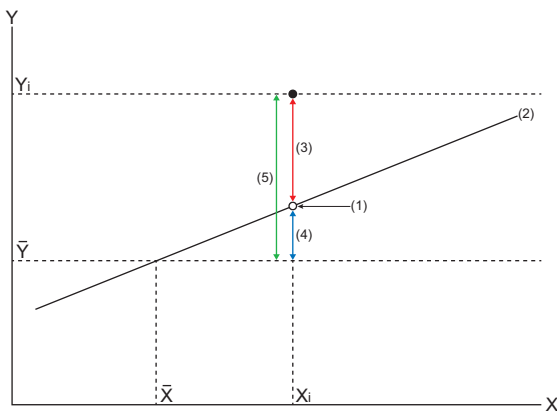

- \bar{X} , \bar{Y} : Mean value
- X_i , Y_i : Measured value
- (1) Predicted Value
- (2) Regression line
- (3) Remaining variation
- (4) Regression variation
- (5) Total variation

- If an overflow occurs during operation, review the input data. A value stored at the occurrence of an overflow varies depending on each engineering tool. Check the specification of the engineering tool used.

- This instruction uses buffer memory for input data and an operation result.

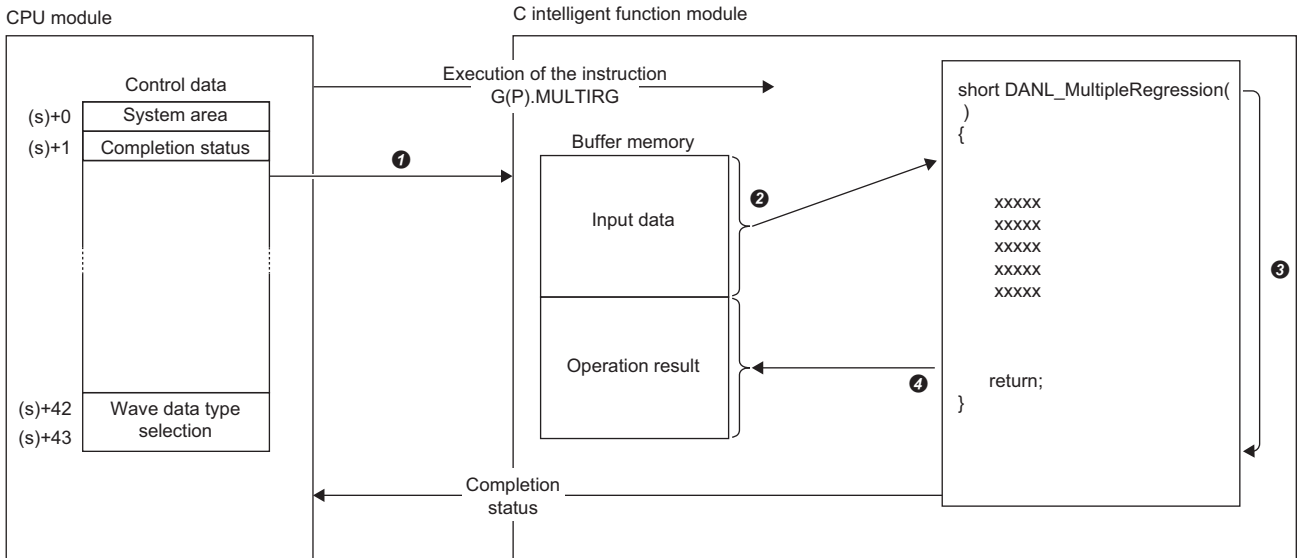

- 1 A value specified in the control data is passed to a C intelligent function module.
- 2 Data for the same number of points specified for the number of data points is read from the buffer memory.
- 3 The statistical analysis function (DANL_MultipleRegression) is executed.
- 4 The operation result is written to the buffer memory of the C intelligent function module and devices in the CPU module.

Item	Description
Input data	From the buffer memory address specified to (s)+2, (s)+3, (s)+6, and (s)+7, data for the same size specified to (s)+4, (s)+5, (s)+8, and (s)+9 is calculated. Before executing this dedicated instruction, store the wave data to be calculated in the buffer memory.
Operation result	Operation results are stored to each of the following storage destinations. <ul style="list-style-type: none"> • From the buffer memory address specified to (s)+18, (s)+19, (s)+22, and (s)+23, data for the same size specified to (s)+12 and (s)+13 is stored as an operation result. • From the buffer memory address specified for (s)+26 to (s)+41, two words worth of data is stored as a multiple correlation coefficient.

- The completion status of the G(P).MULTIRG instruction can be checked with the completion device (d) and the completion status indication device (d)+1.

- Completion device (d)

This device turns on during END processing of the scan where the G(P).MULTIRG instruction completes, and turns off during the next END processing.

- Completion status indication device (d)+1

When completed successfully: The device remains off.

When completed with an error: This device turns on during END processing of the scan where the G(P).MULTIRG instruction completes, and turns off during the next END processing.

- The following figure shows how the G(P).MULTIRG instruction operates during execution.

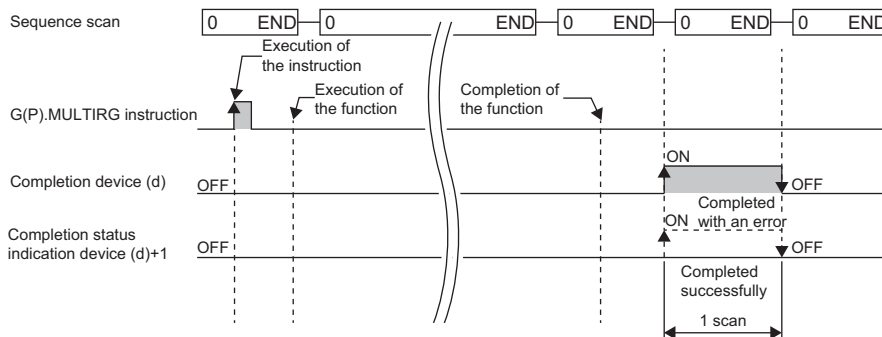

Precautions

- The input and output data type of a data analysis library that is executed by this dedicated instruction is single-precision real number; therefore, specifying double-word type for (s)+42 and (s)+43 may lead to a loss of trailing digits.
- During the execution of this dedicated instruction, neither a dedicated instruction nor an FB can be executed for the same C intelligent function module. The operation under the situation as previously noted is not guaranteed; therefore, arrange a program that executes a dedicated instruction or an FB after the completion device (d) turns on.

Operation error

Error code ((s)+1)	Description
0000H to 3FFFH	 MELSEC iQ-R C Intelligent Function Module User's Manual (Application)

When the instruction completes with an error, the completion status indication device (d)+1 turns on and an error code is stored to the completion status (s)+1.

14 DeviceNet INSTRUCTIONS

Point

This chapter describes the instructions used commonly by MELSEC iQ-R series modules. For the instructions when MELSEC-Q series modules are used, refer to the manuals for each module used and create programs. For precautions when using modules, refer to the following.

 MELSEC iQ-R Module Configuration Manual

14.1 Master Function Receive Data Area Read

G.DNTMRD

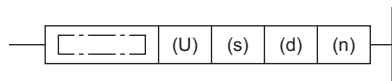

Reads the data from the master function receive data area of the specified module maintaining data consistency.

Ladder	ST
	<pre>ENO:=G_DNTMRD(EN,U,s,d,n);</pre>

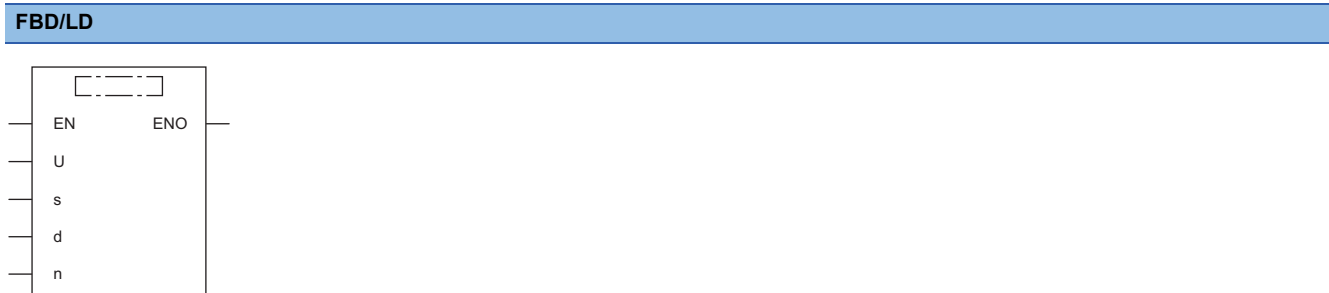

Execution condition

Instruction	Execution condition
G.DNTMRD	

Setting data

Description, range, data type

Operand	Description	Range	Data type	Data type (label)
(U)	Start I/O number of the module (Upper three digits of four-digit hexadecimal)	00H to FEH	16-bit unsigned binary	ANY16
(s)	Start address of the read data	0700H to 07FFH	16-bit unsigned binary	ANY16
(d)	Start device in which the read data is stored	—	Device name	ANY16 ^{*1}
(n)	Number of read data points	001H to 100H	16-bit unsigned binary	ANY16
EN	Execution condition	—	Bit	BOOL
ENO	Execution result	—	Bit	BOOL

*1 When setting with labels, define the array to secure the area required for operation, and specify the element of the array label.

■Applicable device

Operand	Bit		Word			Double word		Indirect specification	Constant			Others (U)
	X, Y, M, L, SM, F, B, SB, FX, FY	J□□	T, ST, C, D, W, SD, SW, FD, R, ZR, RD	U□\G□, J□□, U3E□(H)G□	Z	LT, LST, LC	LZ		K, H	E	\$	
(U)	—	—	○*1	—	—	—	—	—	○	—	—	○
(s)	—	—	○	—	—	—	○	—	○	—	—	—
(d)	—	—	○	—	—	—	○	—	—	—	—	—
(n)	—	—	○	—	—	—	○	—	○	—	—	—

*1 The RD cannot be used.

Processing details

This instruction reads the data from the master function receive data area of the specified module maintaining data consistency.

Operation error

In the following conditions, OPERATION ERROR occurs.

- The name of the dedicated instruction is not set correctly.
- The value set to the setting data is out of the setting range.

14.2 Master Function Transmit Data Area Write

G.DNTMWR

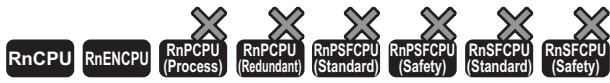

Writes the data to the master function transmit data area of the specified module maintaining data consistency.

Ladder	ST
	<pre>ENO:=G_DNTMWR(EN,U,s1,s2,n);</pre>

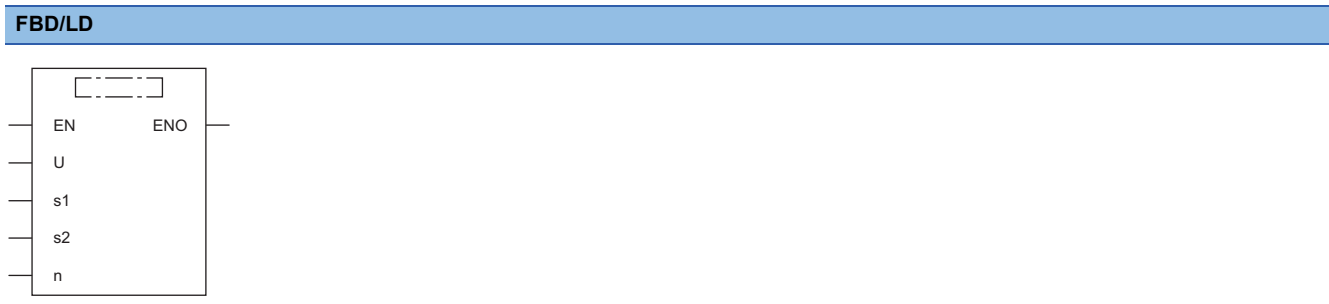

Execution condition

Instruction	Execution condition
G.DNTMWR	

Setting data

Description, range, data type

Operand	Description	Range	Data type	Data type (label)
(U)	Start I/O number of the module (Upper three digits of four-digit hexadecimal)	00H to FEH	16-bit unsigned binary	ANY16
(s1)	Start address for writing the data	0900H to 09FFH	16-bit unsigned binary	ANY16
(s2)	Start number of the device in which the write data is stored	—	Device name	ANY16 ^{*1}
(n)	Number of write data points	001H to 100H	16-bit unsigned binary	ANY16
EN	Execution condition	—	Bit	BOOL
ENO	Execution result	—	Bit	BOOL

*1 When setting with labels, define the array to secure the area required for operation, and specify the element of the array label.

Applicable device

Operand	Bit		Word		Double word		Indirect specification	Constant			Others (U)
	X, Y, M, L, SM, F, B, SB, FX, FY	J□□	T, ST, C, D, W, SD, SW, FD, R, ZR, RD	U□\G□, J□□, U3E□(H)G□	Z	LT, LST, LZ		K, H	E	\$	
(U)	—	—	○ ^{*1}	—	—	—	—	○	—	—	○
(s1)	—	—	○	—	—	—	○	○	—	—	—
(s2)	—	—	○	—	—	—	○	—	—	—	—
(n)	—	—	○	—	—	—	○	○	—	—	—

*1 The RD cannot be used.

Processing details

This instruction writes the data to the master function transmit data area of the specified module maintaining data consistency.

Operation error

In the following conditions, OPERATION ERROR occurs.

- The name of the dedicated instruction is not set correctly.
- The value set to the setting data is out of the setting range.

14.3 Slave Function Receive Data Area Read

G.DNTSRD

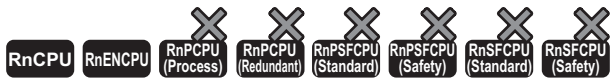

Reads the data from the slave function receive data area of the specified module maintaining data consistency.

Ladder	ST
	<pre>ENO:=G_DNTSRD(EN,U,s,d,n);</pre>

FBD/LD

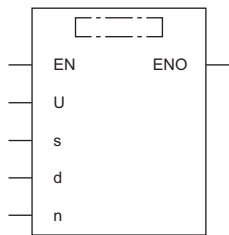

Execution condition

Instruction	Execution condition
G.DNTSRD	

Setting data

Description, range, data type

Operand	Description	Range	Data type	Data type (label)
(U)	Start I/O number of the module (Upper three digits of four-digit hexadecimal)	00H to FEH	16-bit unsigned binary	ANY16
(s)	Start address of the read data	0B00H to 0B3FH	16-bit unsigned binary	ANY16
(d)	Start number of the device in which the read data is stored	—	Device name	ANY16 ^{*1}
(n)	Number of read data points	01H to 40H	16-bit unsigned binary	ANY16
EN	Execution condition	—	Bit	BOOL
ENO	Execution result	—	Bit	BOOL

*1 When setting with labels, define the array to secure the area required for operation, and specify the element of the array label.

Applicable device

Operand	Bit		Word		Double word		Indirect specification	Constant			Others (U)
	X, Y, M, L, SM, F, B, SB, FX, FY	J□□	T, ST, C, D, W, SD, SW, FD, R, ZR, RD	U□\G□, J□□, U3E□(H)G□	Z	LT, LST, LC		LZ	K, H	E	
(U)	—	—	○ ^{*1}	—	—	—	—	○	—	—	○
(s)	—	—	○	—	—	—	○	○	—	—	—
(d)	—	—	○	—	—	—	○	—	—	—	—
(n)	—	—	○	—	—	—	○	○	—	—	—

*1 The RD cannot be used.

Processing details

This instruction reads the data from the slave function receive data area of the specified module maintaining data consistency.

Operation error

In the following conditions, OPERATION ERROR occurs.

- The name of the dedicated instruction is not set correctly.
- The value set to the setting data is out of the setting range.

14.4 Slave Function Transmit Data Area Write

G.DNTSWR

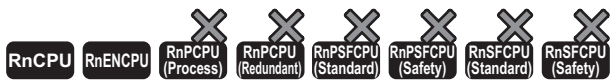

Writes the data to the slave function transmit data area of the specified module maintaining data consistency.

Ladder	ST
	<pre>ENO:=G_DNTSWR(EN,U,s1,s2,n);</pre>

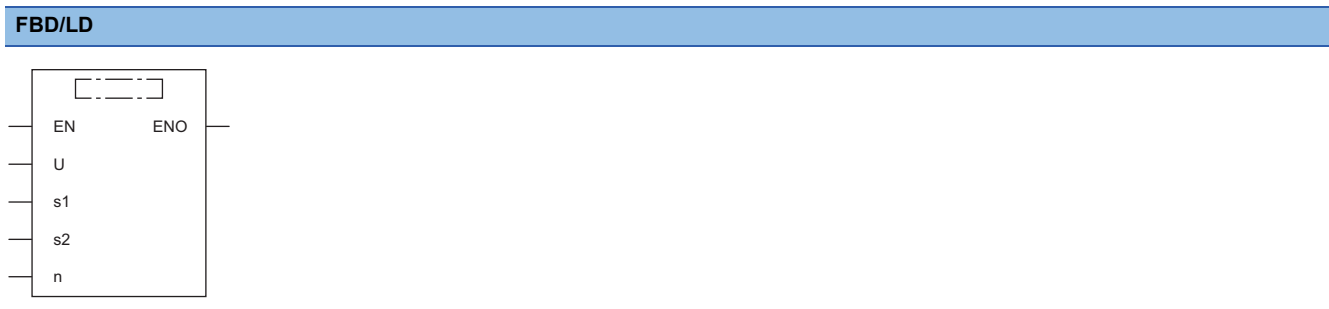

Execution condition

Instruction	Execution condition
G.DNTSWR	

Setting data

Description, range, data type

Operand	Description	Range	Data type	Data type (label)
(U)	Start I/O number of the module (Upper three digits of four-digit hexadecimal)	00H to FEH	16-bit unsigned binary	ANY16
(s1)	Start address for writing the data	0C00H to 0C3FH	16-bit unsigned binary	ANY16
(s2)	Start number of the device in which the write data is stored	—	Device name	ANY16*1
(n)	Number of write data points	01H to 40H	16-bit unsigned binary	ANY16
EN	Execution condition	—	Bit	BOOL
ENO	Execution result	—	Bit	BOOL

*1 When setting with labels, define the array to secure the area required for operation, and specify the element of the array label.

Applicable device

Operand	Bit	Word	Double word	Indirect specification	Constant			Others (U)				
	X, Y, M, L, SM, F, B, SB, FX, FY	J□□□	T, ST, C, D, W, SD, SW, FD, R, ZR, RD		U□\G□, J□□□, U3E□\ (H)G□	Z	LT, LST, LC		LZ	K, H, E, \$		
(U)	—	—	○*1	—	—	—	—	—	○	—	—	○
(s1)	—	—	○	—	—	—	○	—	○	—	—	—
(s2)	—	—	○	—	—	—	○	—	—	—	—	—
(n)	—	—	○	—	—	—	○	—	○	—	—	—

*1 The RD cannot be used.

Processing details

This instruction writes the data to the slave function transmit data area of the specified module maintaining data consistency.

Operation error

In the following conditions, OPERATION ERROR occurs.

- The name of the dedicated instruction is not set correctly.
- The value set to the setting data is out of the setting range.

INDEX

0 to 9

- 16-bit data (word data) 24
- 32-bit data (double word data) 27

A

- A/D conversion instruction 422

B

- Bit data 22
- Buffer memory 9

C

- CC-Link IE Controller Network and MELSECNET/H common instructions 270
- CC-Link IE Field Network instruction 294
- CC-Link IE TSN instructions 212
- CC-Link instruction 340
- Control system 9

D

- Destination (d) 16
- Double-precision real number data 31

E

- Ethernet instruction 171
- Ethernet, CC-Link IE, and MELSECNET/H common instructions 64
- Execution condition 35
- External device 10

I

- Instruction configuration 16

L

- Label 9

M

- Manual page organization 13

N

- Numerical value (n) 17

O

- Operand 9

P

- Positioning instruction 464
- Process CPU 10
- Process CPU (process mode) 9

- Process CPU (redundant mode) 9
- Programmable controller CPU 10

R

- Real number data (floating-point data) 30
- Redundant system 9
- Remote head module 10
- Request message 9
- Response message 9
- RnCPU 10
- RnENCPU 10
- RnENCPU (network part) 9
- RnPCPU 10

S

- Safety CPU 10
- Serial communication instruction 370
- SIL2 function module 9
- SIL2 Process CPU 11
- Single-precision real number data 30
- SLMP 9
- SLMP-compatible device 9
- Source (s) 16
- Standby system 9
- String data 33
- Subset processing 36
- System A 9
- System B 10

INSTRUCTION INDEX

G

G.ABRST1	464
G.ABRST2	464
G.ABRST3	464
G.ABRST4	464
G.BUFRCVS	193
G.DNTMRD	531
G.DNTMWR	533
G.DNTSRD	535
G.DNTSWR	537
G.INPUT	383
G.RECVS	128
G.SOCRCVS	186
G(P).BIDIN	389
G(P).BIDOUT	386
G(P).CCPASET	252,326
G(P).CCPASETX	244
G(P).CEXECUTE	487
G(P).CPRTCL	374
G(P).DIGIFLTR	491
G(P).ENVCALC	498
G(P).FFTSPECT	502
G(P).GETE	415
G(P).LEASTSQ	507
G(P).MTMD	518
G(P).MTUNIT	512
G(P).MULTIRG	524
G(P).OFFGAN	422
G(P).OGLOAD	425
G(P).OGSTOR	444
G(P).ONDEMAND	370
G(P).OUTPUT	379
G(P).PRR	397
G(P).PUTE	412
G(P).RDMSG	364
G(P).REQ	143,152
G(P).RIFR	354
G(P).RIRCV	348
G(P).RIRD	161,340
G(P).RISEND	351
G(P).RITO	356
G(P).RIWT	166,344
G(P).RLPASET	358
G(P).RRUN	270
G(P).RSTOP	275
G(P).RTMRD	280
G(P).RTMWR	285
G(P).SINFSTRD	320
G(P).SINFYRD	314
G(P).SLMPREQ	335
G(P).SLMPSND	260
G(P).SPBUSY	392
G(P).UINI	198,257,291,332
G(P)_BIDIN	389
G(P)_BIDOUT	386
G(P)_CCPASET	252,326
G(P)_CCPASETX	244
G(P)_CEXECUTE	487
G(P)_CPRTCL	374
G(P)_DIGIFLTR	491
G(P)_ENVCALC	498
G(P)_FFTSPECT	502
G(P)_GETE	415
G(P)_LEASTSQ	507
G(P)_MTMD	518
G(P)_MTUNIT	512
G(P)_MULTIRG	524
G(P)_OFFGAN	422
G(P)_OGLOAD	425
G(P)_OGSTOR	444
G(P)_ONDEMAND	370
G(P)_OUTPUT	379
G(P)_PRR	397
G(P)_PUTE	412
G(P)_RDMSG	364
G(P)_REQ	143,152
G(P)_RIFR	354
G(P)_RIRCV	348
G(P)_RIRD	161,340
G(P)_RISEND	351
G(P)_RITO	356
G(P)_RIWT	166,344
G(P)_RLPASET	358
G(P)_RRUN	270
G(P)_RSTOP	275
G(P)_RTMRD	280
G(P)_RTMWR	285
G(P)_SINFSTRD	320
G(P)_SINFYRD	314
G(P)_SLMPREQ	335
G(P)_SLMPSND	260
G(P)_SPBUSY	392
G(P)_UINI	198,257,291,332
G_ABRST1	464
G_ABRST2	464
G_ABRST3	464
G_ABRST4	464
G_BUFRCVS	193
G_DNTMRD	531
G_DNTMWR	533
G_DNTSRD	535
G_DNTSWR	537
G_INPUT	383
GP.BUFRCV	190
GP.BUFSND	195
GP.CLOSE	181
GP.CONCLOSE	175
GP.CONOPEN	171
GP.ECPRTCL	202
GP.ERRCLEAR	207
GP.ERRRD	210
GP.OPEN	177
GP.PFWRT	474
GP.PINIT	477
GP.PSTRT1	468
GP.PSTRT2	468
GP.PSTRT3	468
GP.PSTRT4	468
GP.READ	72
GP.RECV	121
GP.REMFRDIP	238
GP.REMFRIP	232
GP.REMTODIP	241

GP.REMTOIP	235
GP.SEND	111
GP.SOCRCV	184
GP.SOCSND	188
GP.SREAD	81
GP.SWRITE	100
GP.TEACH1	471
GP.TEACH2	471
GP.TEACH3	471
GP.TEACH4	471
GP.WRITE	90
GP_BUFRCV	190
GP_BUFSND	195
GP_CLOSE	181
GP_CONCLOSE	175
GP_CONOPEN	171
GP_ECPRTCL	202
GP_ERRCLEAR	207
GP_ERRRD	210
GP_OPEN	177
GP_PFWRT	474
GP_PINIT	477
GP_PSTR1	468
GP_PSTR2	468
GP_PSTR3	468
GP_PSTR4	468
GP_READ	72
GP_RECV	121
GP_REMFRDIP	238
GP_REMFRIP	232
GP_REMTODIP	241
GP_REMTOIP	235
GP_SEND	111
GP_SOCRCV	184
GP_SOCSND	188
GP_SREAD	81
GP_SWRITE	100
GP_TEACH1	471
GP_TEACH2	471
GP_TEACH3	471
GP_TEACH4	471
GP_WRITE	90
G_RECVS	128
G_SOCRCVS	186

J

J(P).REQ	143,152
J(P).RIRD	161
J(P).RIWT	166
J(P).RRUN	270
J(P).RSTOP	275
J(P).RTMRD	280
J(P).RTMWR	285
J(P).SINFSTRD	320
J(P).SINFTYRD	314
J(P).SLMPREQ	335
J(P).SLMPSND	260
J(P).ZNRD	133
J(P).ZNWR	138
J(P)_REQ	143,152
J(P)_RIRD	161
J(P)_RIWT	166
J(P)_RRUN	270
J(P)_RSTOP	275
J(P)_RTMRD	280

J(P)_RTMWR	285
J(P)_SINFSTRD	320
J(P)_SINFTYRD	314
J(P)_SLMPREQ	335
J(P)_SLMPSND	260
J(P)_ZNRD	133
J(P)_ZNWR	138
JP.READ	72
JP.RECV	121
JP.REMFR	212,294
JP.REMFRD	222,304
JP.REMTO	217,299
JP.REMTOD	227,309
JP.SEND	111
JP.SREAD	81
JP.SWRITE	100
JP.WRITE	90
JP_READ	72
JP_RECV	121
JP_REMFR	212,294
JP_REMFRD	222,304
JP_REMTO	217,299
JP_REMTOD	227,309
JP_SEND	111
JP_SREAD	81
JP_SWRITE	100
JP_WRITE	90

Z

Z.ABRST1	464
Z.ABRST2	464
Z.ABRST3	464
Z.ABRST4	464
Z.BUFRCVS	193,394
Z.RECVS	128
Z(P).RCPREAD	484
Z(P).RCPWRITE	480
Z(P).RRUN	270
Z(P).RSTOP	275
Z(P).RTMRD	280
Z(P).RTMWR	285
Z(P).UINI	198,257,291,332
Z(P)_RCPREAD	484
Z(P)_RCPWRITE	480
Z(P)_RRUN	270
Z(P)_RSTOP	275
Z(P)_RTMRD	280
Z(P)_RTMWR	285
Z(P)_UINI	198,257,291,332
Z_ABRST1	464
Z_ABRST2	464
Z_ABRST3	464
Z_ABRST4	464
Z_BUFRCVS	193,394
ZP.BUFRCV	190
ZP.BUFSND	195
ZP.CLOSE	181
ZP.CSET	400,403,408
ZP.ERRCLEAR	207
ZP.ERRRD	210
ZP.OPEN	177
ZP.PFWRT	474
ZP.PINIT	477
ZP.PSTR1	468
ZP.PSTR2	468

ZP.PSTRT3	468
ZP.PSTRT4	468
ZP.REMFR	212,294
ZP.REMTO	217,299
ZP.TEACH1	471
ZP.TEACH2	471
ZP.TEACH3	471
ZP.TEACH4	471
ZP.UINI	419
ZP_BUFRCV	190
ZP_BUFSND	195
ZP_CLOSE	181
ZP_CSET	400,403,408
ZP_ERRCLEAR	207
ZP_ERRRD	210
ZP_OPEN	177
ZP_PFWRT	474
ZP_PINIT	477
ZP_PSTRT1	468
ZP_PSTRT2	468
ZP_PSTRT3	468
ZP_PSTRT4	468
ZP_REMFR	212,294
ZP_REMTO	217,299
ZP_TEACH1	471
ZP_TEACH2	471
ZP_TEACH3	471
ZP_TEACH4	471
ZP_UINI	419
Z_RECVS	128



REVISIONS

*The manual number is given on the bottom left of the back cover.

Revision date	*Manual number	Description
April 2018	SH(NA)-081976ENG-A	First edition
September 2018	SH(NA)-081976ENG-B	■Added or modified part Section 12.1
May 2019	SH(NA)-081976ENG-C	■Added or modified parts TERMS, Section 2.1, 2.3, 2.5, 2.11, 3.1, 3.2, Chapter 5, Section 7.9, Chapter 13
May 2019	SH(NA)-081976ENG-D	■Added or modified parts TERMS, GENERIC TERMS AND ABBREVIATIONS, Section 3.1, 5.9, 5.10, 7.7
October 2019	SH(NA)-081976ENG-E	■Added or modified parts Section 2.3, 5.9
February 2020	SH(NA)-081976ENG-F	■Added or modified parts GENERIC TERMS AND ABBREVIATIONS, Section 2.1, 2.4, Chapter 3, Section 3.1, Chapter 6, Section 6.1, 6.2, 6.3, 6.4

Japanese manual number: SH-081975-F

This manual confers no industrial property rights of any other kind, nor does it confer any patent licenses. Mitsubishi Electric Corporation cannot be held responsible for any problems involving industrial property rights which may occur as a result of using the contents noted in this manual.

© 2018 MITSUBISHI ELECTRIC CORPORATION

WARRANTY

Please confirm the following product warranty details before using this product.

1. Gratis Warranty Term and Gratis Warranty Range

If any faults or defects (hereinafter "Failure") found to be the responsibility of Mitsubishi occurs during use of the product within the gratis warranty term, the product shall be repaired at no cost via the sales representative or Mitsubishi Service Company.

However, if repairs are required onsite at domestic or overseas location, expenses to send an engineer will be solely at the customer's discretion. Mitsubishi shall not be held responsible for any re-commissioning, maintenance, or testing on-site that involves replacement of the failed module.

[Gratis Warranty Term]

The gratis warranty term of the product shall be for one year after the date of purchase or delivery to a designated place. Note that after manufacture and shipment from Mitsubishi, the maximum distribution period shall be six (6) months, and the longest gratis warranty term after manufacturing shall be eighteen (18) months. The gratis warranty term of repair parts shall not exceed the gratis warranty term before repairs.

[Gratis Warranty Range]

- (1) The range shall be limited to normal use within the usage state, usage methods and usage environment, etc., which follow the conditions and precautions, etc., given in the instruction manual, user's manual and caution labels on the product.
- (2) Even within the gratis warranty term, repairs shall be charged for in the following cases.
 1. Failure occurring from inappropriate storage or handling, carelessness or negligence by the user. Failure caused by the user's hardware or software design.
 2. Failure caused by unapproved modifications, etc., to the product by the user.
 3. When the Mitsubishi product is assembled into a user's device, Failure that could have been avoided if functions or structures, judged as necessary in the legal safety measures the user's device is subject to or as necessary by industry standards, had been provided.
 4. Failure that could have been avoided if consumable parts (battery, backlight, fuse, etc.) designated in the instruction manual had been correctly serviced or replaced.
 5. Failure caused by external irresistible forces such as fires or abnormal voltages, and Failure caused by force majeure such as earthquakes, lightning, wind and water damage.
 6. Failure caused by reasons unpredictable by scientific technology standards at time of shipment from Mitsubishi.
 7. Any other failure found not to be the responsibility of Mitsubishi or that admitted not to be so by the user.

2. Onerous repair term after discontinuation of production

- (1) Mitsubishi shall accept onerous product repairs for seven (7) years after production of the product is discontinued. Discontinuation of production shall be notified with Mitsubishi Technical Bulletins, etc.
- (2) Product supply (including repair parts) is not available after production is discontinued.

3. Overseas service

Overseas, repairs shall be accepted by Mitsubishi's local overseas FA Center. Note that the repair conditions at each FA Center may differ.

4. Exclusion of loss in opportunity and secondary loss from warranty liability

Regardless of the gratis warranty term, Mitsubishi shall not be liable for compensation to:

- (1) Damages caused by any cause found not to be the responsibility of Mitsubishi.
- (2) Loss in opportunity, lost profits incurred to the user by Failures of Mitsubishi products.
- (3) Special damages and secondary damages whether foreseeable or not, compensation for accidents, and compensation for damages to products other than Mitsubishi products.
- (4) Replacement by the user, maintenance of on-site equipment, start-up test run and other tasks.

5. Changes in product specifications

The specifications given in the catalogs, manuals or technical documents are subject to change without prior notice.

TRADEMARKS

DeviceNet is a trademark of ODVA, Inc.

Microsoft, Microsoft Access, Excel, SQL Server, Visual Basic, Visual C++, Visual Studio, Windows, Windows NT, Windows Server, Windows Vista, and Windows XP are either registered trademarks or trademarks of Microsoft Corporation in the United States and/or other countries.

The company names, system names and product names mentioned in this manual are either registered trademarks or trademarks of their respective companies.

In some cases, trademark symbols such as [™] or [®] are not specified in this manual.

SH(NA)-081976ENG-F(2002)

mitsubishi electric corporation

HEAD OFFICE : TOKYO BUILDING, 2-7-3 MARUNOUCHI, CHIYODA-KU, TOKYO 100-8310, JAPAN
NAGOYA WORKS : 1-14, YADA-MINAMI 5-CHOME, HIGASHI-KU, NAGOYA, JAPAN

When exported from Japan, this manual does not require application to the
Ministry of Economy, Trade and Industry for service transaction permission.

Specifications subject to change without notice.